

ARCHITECTURAL



F A R O
BARCELONA



Edition

A2026ARCH

Art direction and design

Faro Art

All Rights Reserved

Reproduction without written permission from the publisher is strictly prohibited.



Architectural Collection

Tracklights	25
Recessed	75
Surface	271
Suspended	365
Systems	401
Ledstrip	487
Connectivity	500
Drivers	506

Tracklights



Linse Track
27



Fost
41



Blit
53



Via
59



Tracks
69

Recessed



Linse Recessed
77



Kira Pinhole
85



Elios
93



Alia
113



Izar
121



Tulipa
127



Uno
137



Fost Recessed
223



Fost Pulldown
231



Teide
239



Podium
251



Backlight
265

Surface



Tak Surface
273

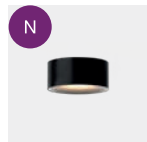

Tek Surface
281



Domio
289



Troop Surface
301



Blit Surface
311



Scuba
319



Proofline
327

Suspended

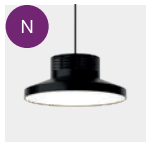

Tak Suspended
367

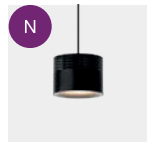

Tek Suspended
375

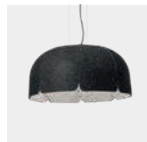

Mute
383



Fost Suspended
391

Systems

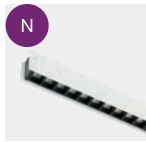

Luva
403



Neso
417



Neso Slim
432



Via Evo
457



Fonovia
477

Ledstrip

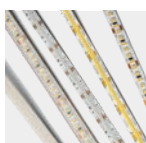

Ledstrip
487



Kope
147



Deep
153



Troop
167



Kimo
179



Kobo
195



Croc
193

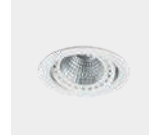

Optic
201



Colin
209



**Fost
Surface**
333



**Fost
Ceiling**
343



**Podium
Surface**
353

Our purpose is to contribute to the wellbeing and happiness of people through design and the relationship we establish with the objects that surround us in our daily lives. We believe in honest and accessible design. Nuestra razón de ser es contribuir al bienestar y la felicidad de las personas a través del diseño y la relación que establecemos con los objetos que nos acompañan en nuestro día a día. Creemos en un diseño honesto, accesible y cercano.

DESIGN FOR
EVERYONE

BRAND
WITH SOUL







Our sustainability journey focuses on minimizing our environmental footprint and maximizing our positive impact on society.

Nuestro camino hacia la sostenibilidad se centra en reducir nuestro impacto negativo en el planeta y maximizar nuestro impacto social positivo.

SUSTAINABILITY

TURN OFF
THE LIGHT



Our impact report
Nuestro impacto



The expertise and knowledge of our professionals are dedicated to bringing your ideas to life, creating unique and functional spaces.

La experiencia y el conocimiento de nuestros profesionales se ponen al servicio de tus ideas para crear espacios únicos y funcionales.

SERVICES

YOUR IDEA, OUR EXPERTISE

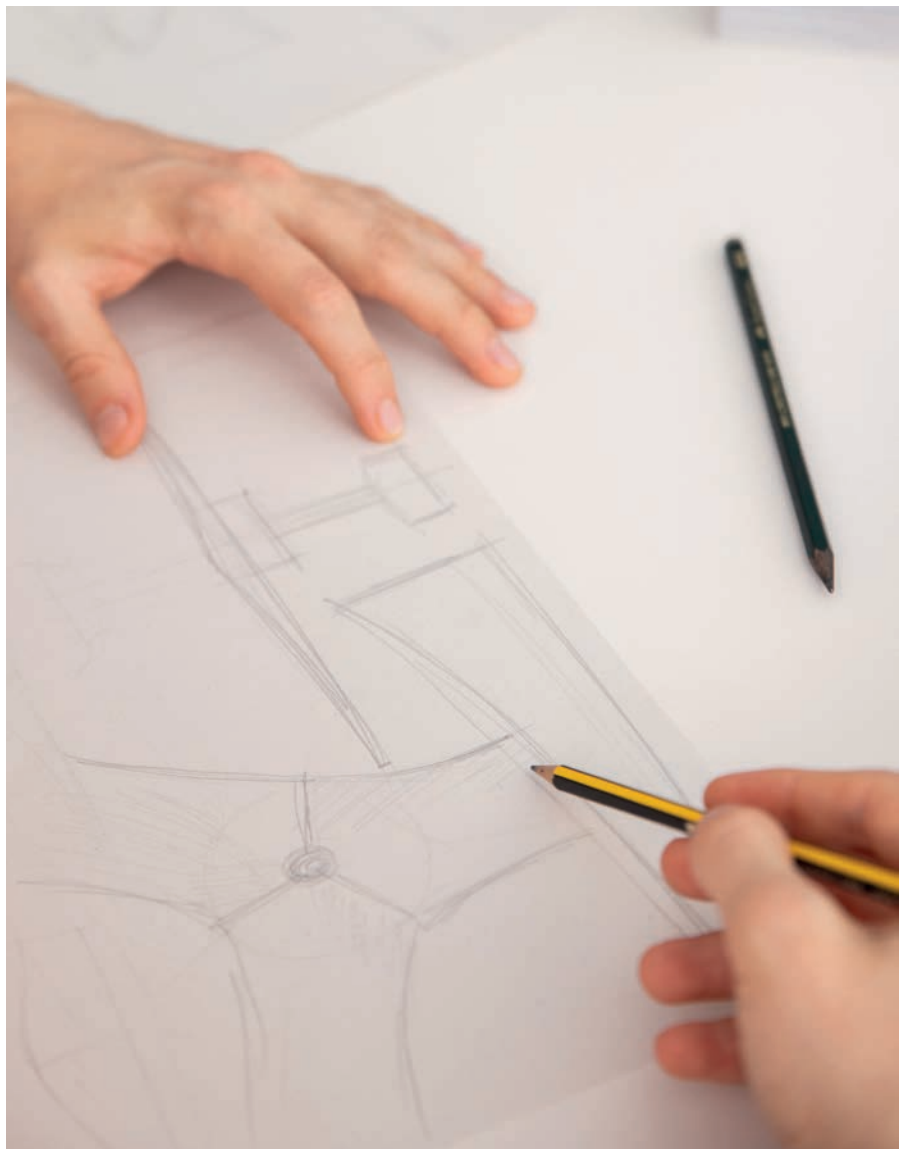

Lighting & Fan projects / Proyectos de iluminación y ventilación
Control and connectivity / Control y conectividad
Customization and bespoke products / Personalización y productos a medida



Our commitment to quality is at the heart of everything we design. We rigorously control the quality of our products and services from conception to functionality and reliability testing. Nuestro compromiso con la calidad está presente en todo lo que diseñamos. Controlamos rigurosamente la calidad de nuestros productos y servicios desde la concepción hasta los ensayos de funcionalidad y fiabilidad.

Q-LAB

QUALITY
COMMITMENT



Quality management system based on ISO9001.

Compliance with electrical safety regulations under EN60598 (lighting) & EN60335 (fans), as well as ERP energy-efficiency requirements.

Sistema de gestión de calidad basado en la ISO9001.

Cumplimiento legislativo de las normativas de seguridad bajo la EN60598 (iluminación) y EN60335 (ventiladores de techo), así como la normativa de eficiencia energética ERP.

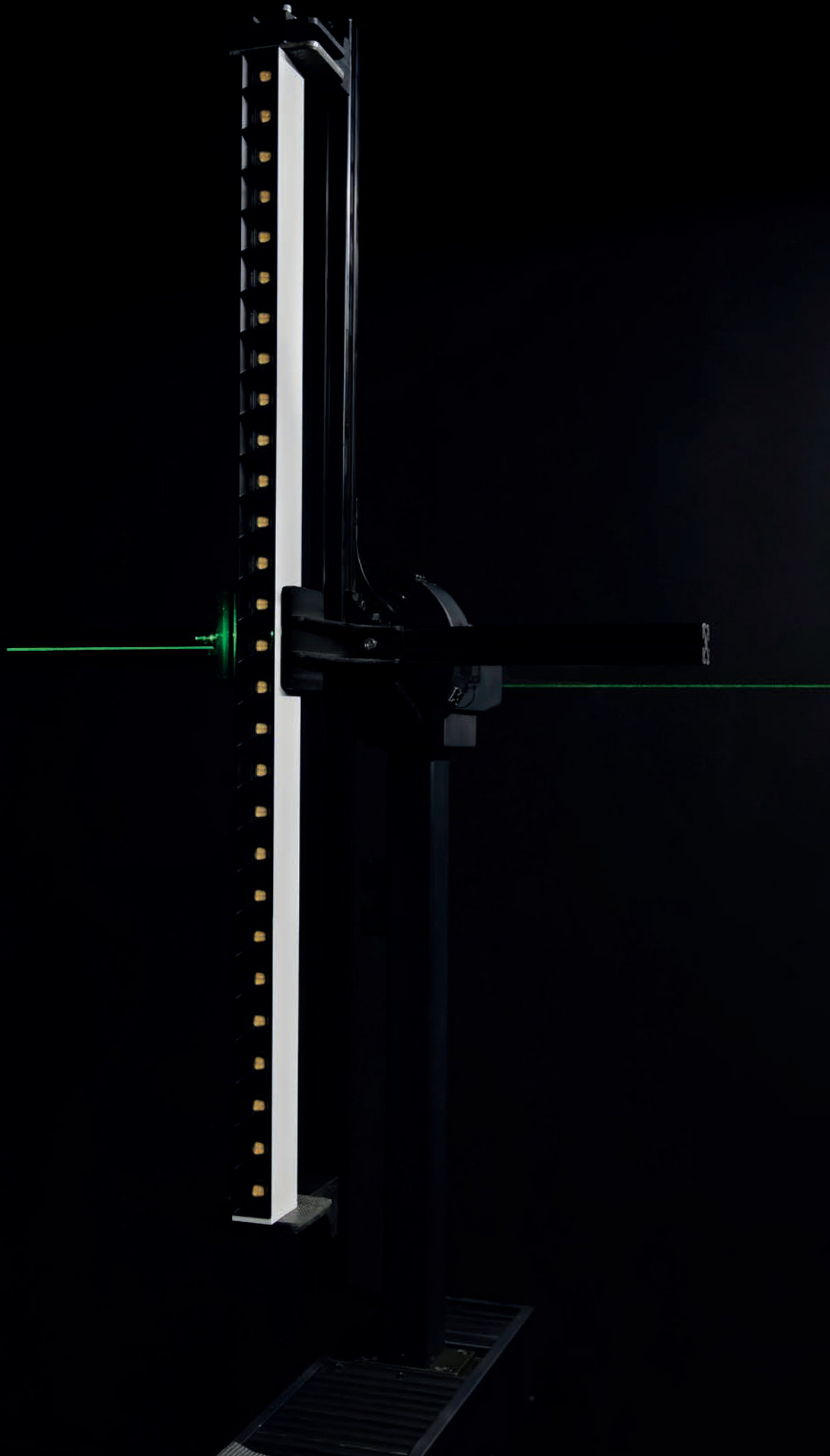

At Faro Barcelona, our expert team in lighting and interior design supports you at every stage of your projects, from needs interpretation and calculations to implementation. We provide personalized advice and thorough follow-up, focusing on environmental care, architectural enhancement, and aesthetic trends.

En Faro Barcelona contamos con un equipo experto en iluminación e interiorismo que te acompaña en cada etapa de tus proyectos, desde la interpretación de necesidades y cálculos hasta la implementación. Ofrecemos asesoría personalizada y seguimiento completo, cuidando el entorno, realzando la arquitectura y siguiendo las tendencias estéticas.

PROYECTOS DE ILUMINACIÓN

LIGHTING PROJECTS

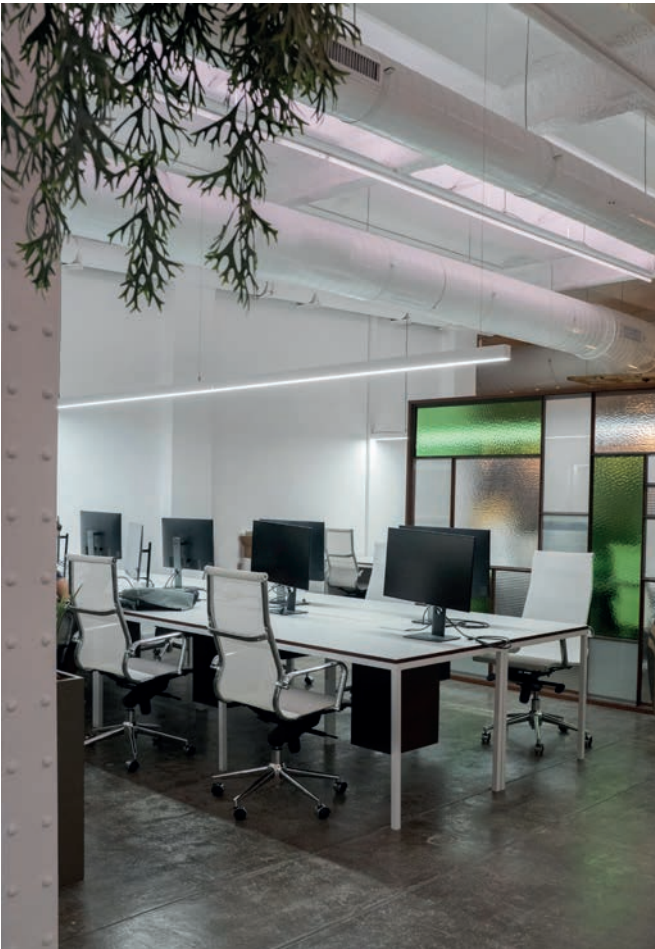

Need consulting for your project?
¿Necesitas asesoramiento para tu proyecto?



At Faro Barcelona, we design high-quality lighting solutions with control, connectivity, and customization to fit each space. Our approach enhances well-being by providing flexibility, energy efficiency, and sustainable experiences.

En Faro Barcelona diseñamos soluciones de iluminación de calidad, con control, conectividad y personalización, para adaptarse a cada espacio. Nuestro enfoque busca mejorar el bienestar, ofreciendo flexibilidad, eficiencia energética y experiencias sostenibles.

**CONTROL
Y CONECTIVIDAD**

**CONTROL
& CONNECTIVITY**





At Faro Barcelona, we create Human Centric Lighting (HCL) solutions that synchronize artificial light with the circadian cycle, enhancing physical and emotional well-being, sleep, and efficiency, fostering holistic and balanced health.

En Faro Barcelona desarrollamos soluciones de Human Centric Lighting (HCL) que sincronizan la luz artificial con el ciclo circadiano, mejorando el bienestar físico y emocional, el sueño y la eficiencia, promoviendo una salud integral y equilibrada.

LUZ
INTEGRADA

INTEGRATIVE
LIGHTING



Note: Our luminaires with **Tunable White (TW)** technology offer this capability, adapting to the needs of each moment of the day.
Nota: Nuestras luminarias con tecnología **Tunable White (TW)** ofrecen esta posibilidad, adaptándose a las necesidades de cada momento del día.

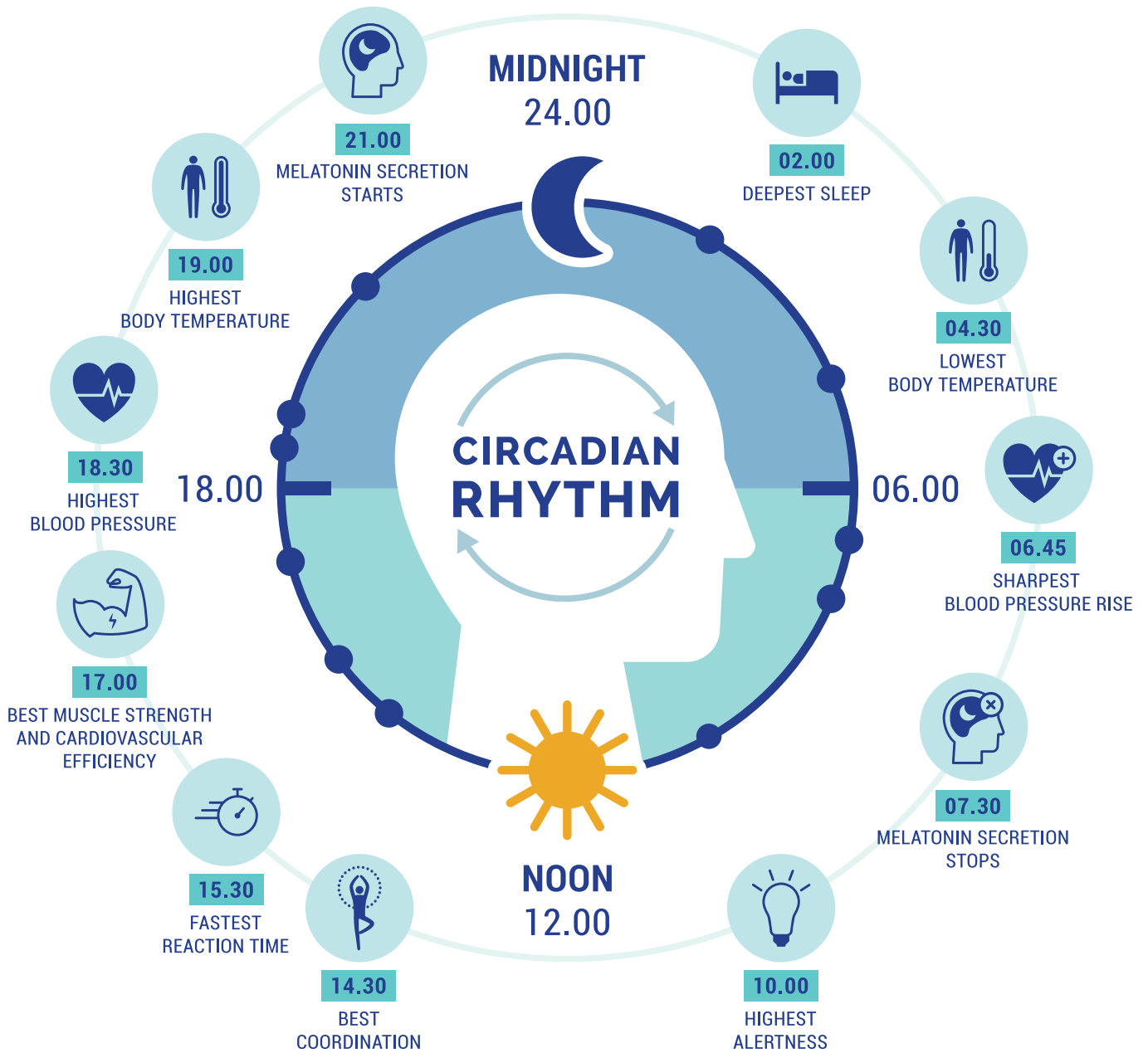

At Faro Barcelona, we design luminaires that prioritize health and comfort, offering stable lighting, high CRI for accurate colors, and low UGR to reduce glare. Our designs meet photobiological safety standards, ensuring a safe and comfortable visual experience.

En Faro Barcelona diseñamos luminarias que cuidan la salud y el confort, con iluminación estable, alto IRC para colores reales y bajo UGR para minimizar el deslumbramiento. Cumplimos estándares de seguridad fotobiológica, asegurando una experiencia visual segura y cómoda.

ILUMINACIÓN
SALUDABLE

HEALTHY
LIGHTING



Human beings evolved under sunlight and fire, adapting to their natural spectrums. Thrive technology recreates this light with an artificial spectrum that is as close to sunlight as possible, promoting biological balance and a healthier, more productive visual environment, ideal for everyday well-being. Los seres humanos hemos evolucionado bajo la luz natural del sol y el fuego, adaptándonos a sus espectros. La tecnología Thrive recrea esta luz con un espectro artificial lo más parecido posible al del sol, promoviendo el equilibrio biológico y un entorno visual más saludable y productivo, ideal para el bienestar diario.

TECNOLOGÍA THRIVE

THRIVE TECHNOLOGY

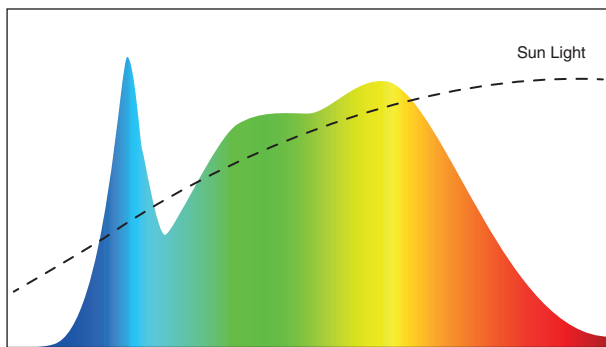

CRI 90 LED (ASD 19%)

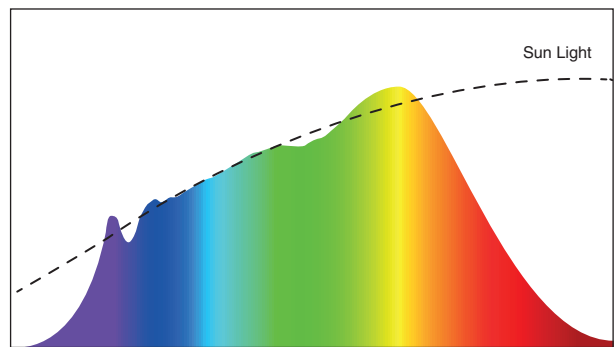

THRIVE LED (ASD 8%)



THRIVE TECHNOLOGY

PROMOTES WELL-BEING PROMUEVE EL BIENESTAR

Thrive reduces excessive blue light, supporting the circadian rhythm, better sleep, and improved mood.
Thrive reduce la luz azul excesiva, favoreciendo el ritmo circadiano, un sueño más reparador y mejorando el ánimo.

REDUCTION OF HARMFUL BLUE LIGHT REDUCCIÓN DE LUZ AZUL NOCIVA

Thrive smooths blue light peaks, protecting eye health and circadian rhythms.
Thrive suaviza los picos de luz azul, cuidando la salud ocular y los ritmos circadianos.

BENEFITS AND APPLICATIONS BENEFICIOS Y APLICACIONES

LOWER ASD MENOR ASD

Thrive technology offers an ASD of 9%, compared to 18% in high-quality LEDs (CRI 98), delivering light closer to natural and a more comfortable visual experience.
La tecnología Thrive tiene un ASD del 9%, frente al 18% de los LEDs de alta calidad (CRI 98), logrando una luz más similar a la natural y una experiencia visual más cómoda.

COMMON APPLICATIONS APLICACIONES COMUNES

Thrive is perfect for spaces needing quality light and comfort: fashion stores, offices, schools, and healthcare settings.
Thrive es ideal para espacios que requieren luz de calidad y confort: tiendas de moda, oficinas, escuelas y entornos sanitarios.

TRACK

LIGHTS

The LINSE projector family stands out for its versatility and adaptability to various applications. Available in three configurations: 3-phase track, recessed, and Neso magnetic system version. This wide range offers flexible solutions for each project. It includes a standard projector and a varifocus version with adjustable beam angle to suit different environments. The framing projector is ideal for illuminating artwork or projecting logos, enhancing the identity of the space. LINSE also features LED THRIVE technology, delivering healthy, natural lighting that enhances colors and details with high quality.

La familia LINSE de proyectores se caracteriza por su versatilidad y adaptación a diversas aplicaciones. Disponible en versión track 3-phase, empotrable y para el sistema magnético Neso, ofrece soluciones flexibles para realzar espacios. Incluye un proyector estándar y otro varifocus con ángulo de haz ajustable, adaptando la luz al entorno. La versión de recorte es ideal para iluminar arte o proyectar logos, destacando la identidad del lugar. Además, LINSE incorpora tecnología LED THRIVE, que proporciona una iluminación saludable y natural, resaltando colores y detalles con alta calidad.

Designed by Faro Lab



NEW

LINSE



TRACK



LINSE Collection



Recessed
77



Neso Slim
450

MODULE
Modulo

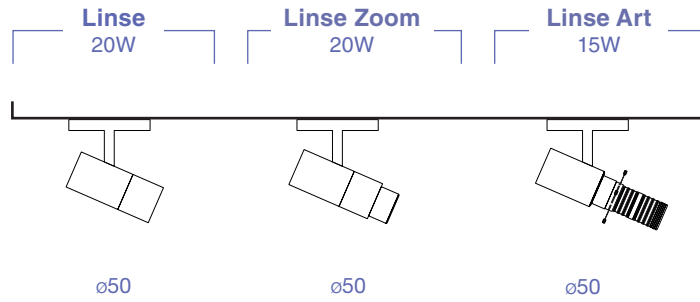

FINISH
Acabado

- **Black**
Negro
- **White**
Blanco

COLOR TEMPERATURE
Temperatura de color

- 2700K CRI90
- 3000K CRI90
- 4000K CRI90
- 2700K THRIVE
- 3000K THRIVE
- 4000K THRIVE

BEAM ANGLE
Ángulo de apertura

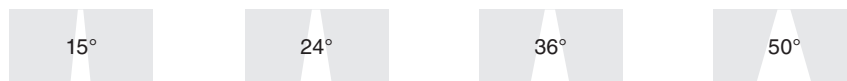

ACCESSORIES
Accesorios

- White Ring
- Gold Ring
- Honeycomb
- Striped Glass
- Long Snoot
- Cinema

CONTROL SYSTEM
Sistema de control



CASAMBI

How to use Linse Art

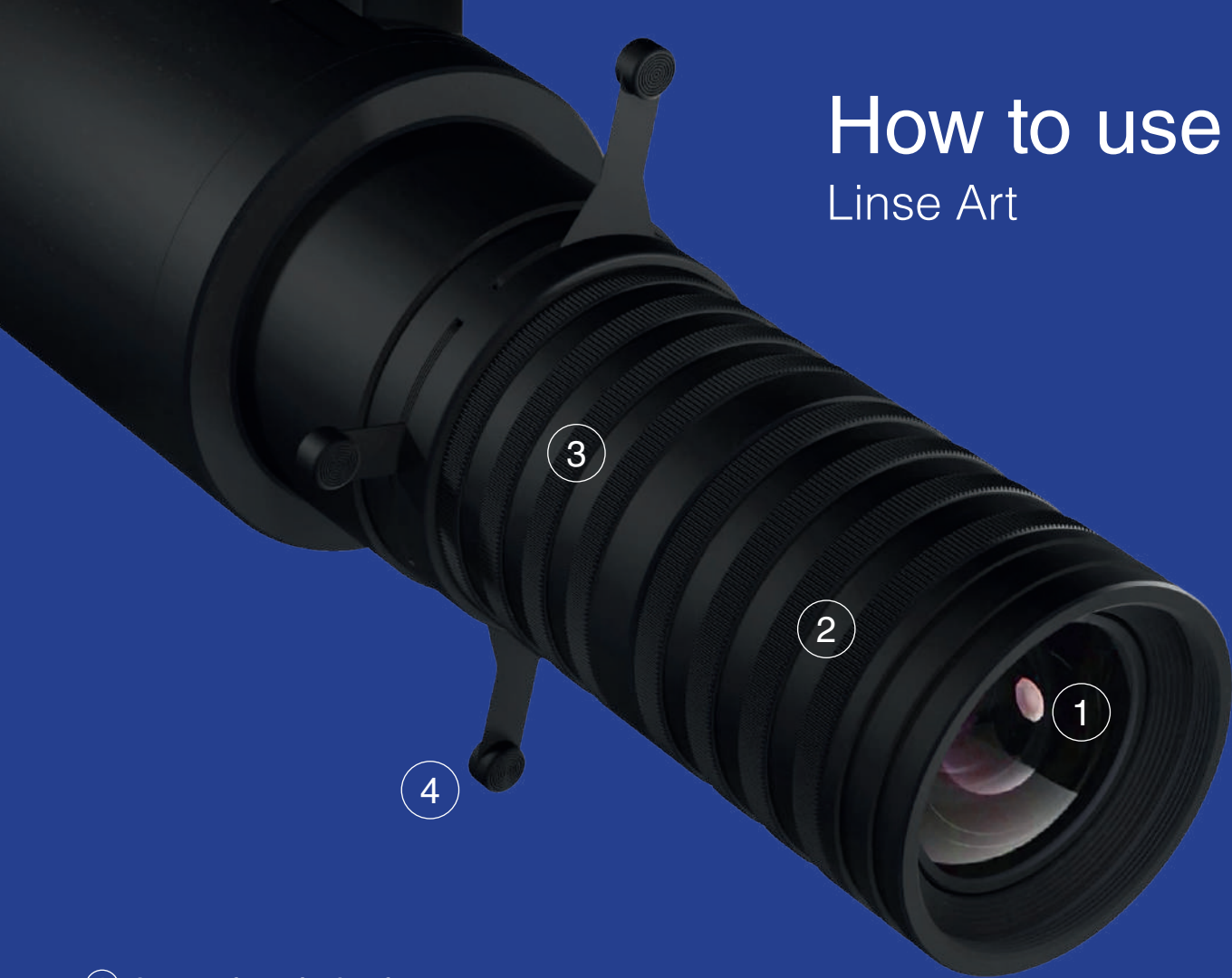

- ① **Lens set for optimal performance**
Juego de lentes para una óptima función

High-precision optics ensuring maximum efficiency and accurate beam control.

Óptica de alta precisión que garantiza máxima eficiencia y control del haz.

- ② **Multi-layer dry damping design**
Diseño de amortiguación seca multicapa

Smooth rotation system for stable and precise beam adjustment.
Sistema de rotación fluida para un ajuste estable y preciso del haz.

- ③ **Adjustable focus mechanism**
Mecanismo de enfoque ajustable

Rotation allows fine-tuning of beam sharpness and precise spot.
La rotación permite ajustar la nitidez y definir con precisión el punto.

- ④ **Variable aperture optical design**
Diseño óptico de apertura variable

Manual light-cut sheet for shaping and controlling the beam contour.

Láminas de corte manual para modelar y controlar el contorno del haz.



Movements and
Directions

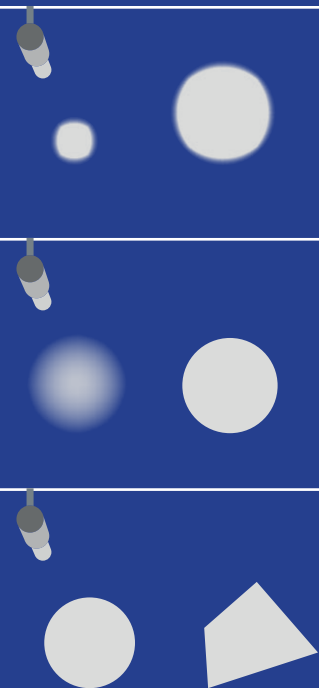

Customize your Gobo

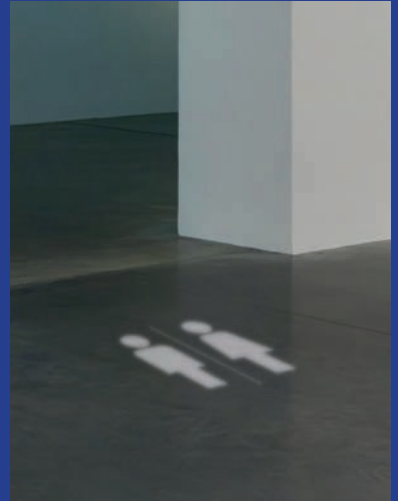
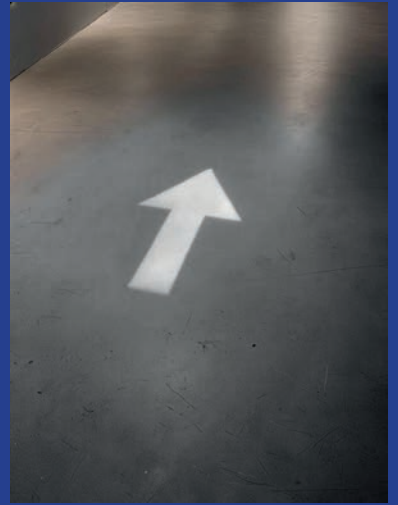

Gobo



ø15 to 17mm

*Custom design service / Servicio de diseños personalizados

Linse Zoom



15° to 50°
variable angle

Highlights

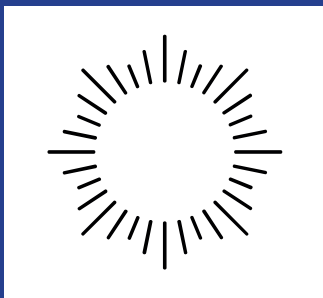

Thrive Technology
Tecnología Thrive



Compatible with Neso Slim
Compatible con Neso Slim



Gobo

Its multiple accessories and combinations make it easy to personalize the product, allowing beam modification or glare reduction.

Sus múltiples accesorios y combinaciones facilitan la personalización del producto que hace posible la modificación de haz o reducir el deslumbramiento.

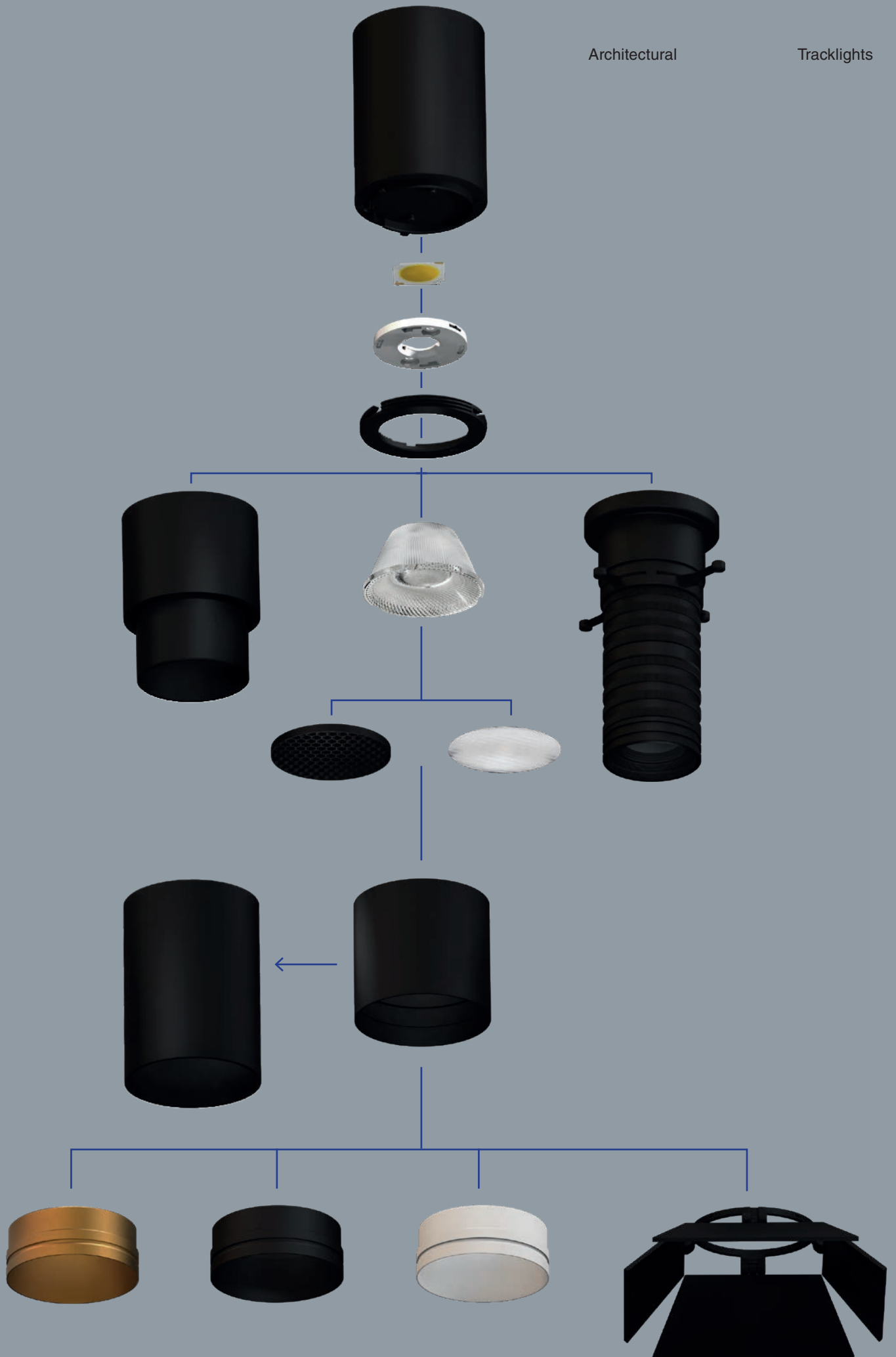

*These accessories are only suitable for standard Linse, not suitable for ZOOM or ART.

*Estos accesorios sólo son aptos para objetivos estándar, no son aptos para objetivos ZOOM ni ART.

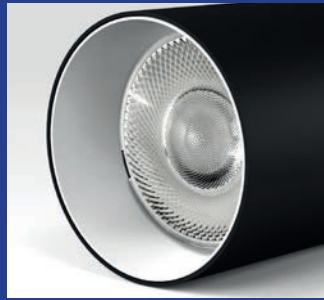

White Ring
Anillo Blanco

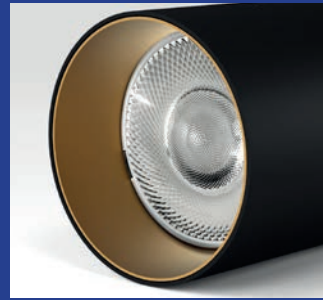

Golden Ring
Anillo Dorado

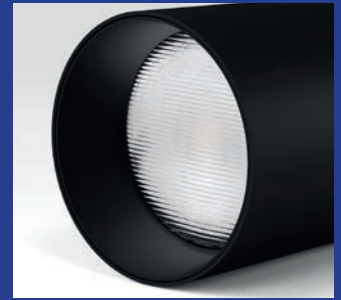

Striped Glass
Vidrio Estriado



Cinema



Long Snoot
Visera Larga



Honeycomb
Panal de Abeja



Without Accessory



Striped Glass

Accessories

White Ring	Gold Ring	Striped Glass	Cinema	Long Snoot	Honeycomb
0390PP0061	0390PP0063	0390000072	0390000073	● 0390PP0031	0390000070
-	-	-	-	● 0390PP0032	-

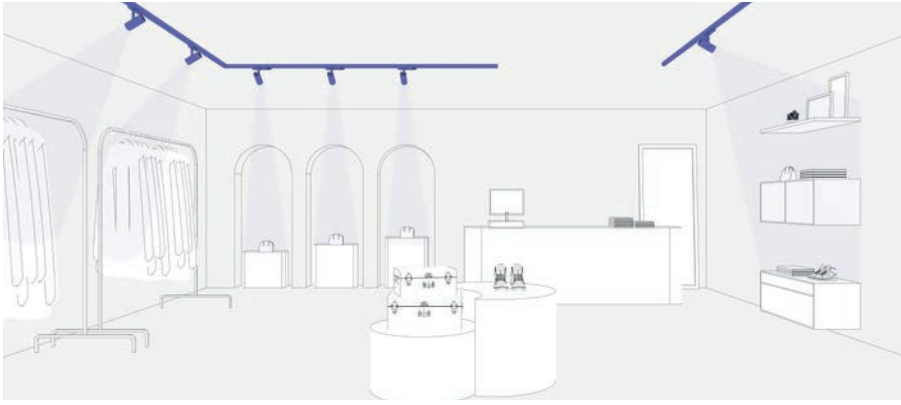

Retail

Beam Angle



15°

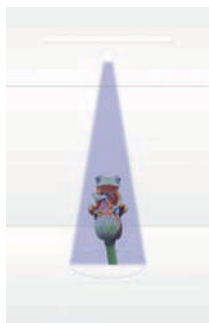

24°

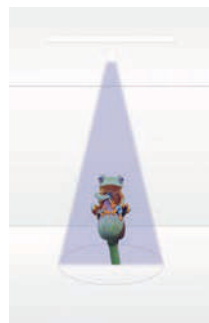

36°



50°

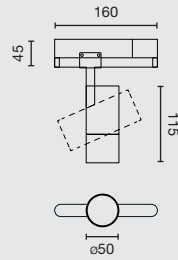

Family	Color T	Beam Angle	Finish	Control System
0391 Linse Track	2 20W	1 15° 2 24° 3 36° 5 50°	1 White 2 Black	W CASAMBI D DALI ON/OFF
	927 2700K CRI90 930 3000K CRI90 940 4000K CRI90 T27 2700K THRIVE T30 3000K THRIVE T40 4000K THRIVE			

0391 **1** **927** **1** **1** **W**

Example **0391292711W** — Linse Track 20W 2700K CRI90 15° White Casambi

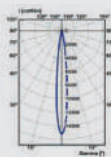

15°

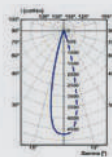

24°

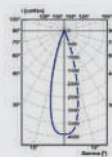

36°

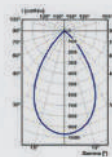

50°

Option	Color T	CRI	Power	Lumen Output	Beam Angle
927	2700K	90	20W	1309 / 1643 / 1641 / 1602	15° / 24° / 36° / 50°
T27		THRIVE	20W	1154 / 1449 / 1448 / 1414	15° / 24° / 36° / 50°
930	3000K	90	20W	1349 / 1694 / 1692 / 1651	15° / 24° / 36° / 50°
T30		THRIVE	20W	1190 / 1494 / 1492 / 1456	15° / 24° / 36° / 50°
940	4000K	90	20W	1389 / 1745 / 1742 / 1701	15° / 24° / 36° / 50°
T40		THRIVE	20W	1226 / 1539 / 1537 / 1500	15° / 24° / 36° / 50°

LINSE ZOOM TRACK

NEW

incl. DIM 355° 90° 50.000hs L80 / B10 MacAdam 2&3 220-240V 650°C

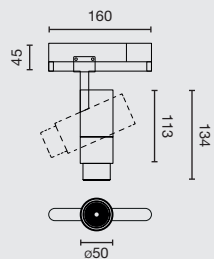

Family	Color T	Beam Angle	Finish	Control System
0391 Linse Zoom Track	2 20W	6 20° - 50°	1 White 2 Black	W CASAMBI D DALI ON/OFF
	927 2700K CRI90			
	930 3000K CRI90			
	940 4000K CRI90			
	T27 2700K THRIVE			
	T30 3000K THRIVE			
	T40 4000K THRIVE			

0391 1 927 6 1 W

Example 0391292761W — Linse Zoom Track 20W 2700K CRI90 20°-50° White Casambi



20°

50°

Option	Color T	CRI	Power	Lumen Output	Beam Angle
927	2700K	90	20W	415 / 624	20° to 50°
T27		THRIVE	20W	403 / 605	20° to 50°
930	3000K	90	20W	427 / 643	20° to 50°
T30		THRIVE	20W	356 / 534	20° to 50°
940	4000K	90	20W	376 / 567	20° to 50°
T40		THRIVE	20W	366 / 551	20° to 50°

LINSE ART TRACK



- incl.
- DIM
- 355°
- 90°
- 50.000hs
L80 / B10
- MacAdam
2&3
- 220-
240V
- 650°C

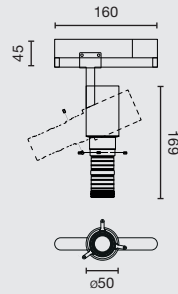

Family	Color T	Beam Angle	Finish	Control System
0391 Linse Art Track	1 15W	927 2700K CRI90	7 Framer Spot	1 White
		930 3000K CRI90		2 Black
		940 4000K CRI90		W CASAMBI
		T27 2700K THRIVE		D DALI
		T30 3000K THRIVE		ON/OFF
		T40 4000K THRIVE		

0391 **1** **927** **7** **1** **W**

Example **0391192771W** — Linse Art Track 15W 2700K CRI90 Framer Spot White Casambi

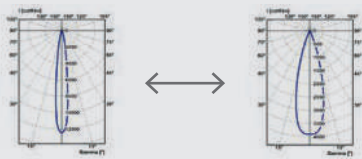

18°

36°

Option	Color T	CRI	Power	Lumen Output	Beam Angle
927	2700K	90	15W	163 / 306	18° to 36°
T27		THRIVE	15W	160 / 300	18° to 36°
930	3000K	90	15W	168 / 315	18° to 36°
T30		THRIVE	15W	141 / 265	18° to 36°
940	4000K	90	15W	149 / 278	18° to 36°
T40		THRIVE	15W	144 / 270	18° to 36°



The FOST TRACK family of track projectors was born to meet the need to accentuate what needs to be highlighted. A minimalist design that is easy to integrate into any space, bringing the architecture to the forefront. The location of the driver in the actual track adaptor facilitates this integration.

La familia de proyectores a carril FOST TRACK nace para dar respuesta a la necesidad de poner acento a lo que debe ser destacado. Un diseño minimalista de fácil integración en cualquier espacio dando protagonismo a la arquitectura. La ubicación del driver en el propio adaptador a carril facilita esta integración.



FOST



T R A C K



FOST Collection



Recessed
223



Pulldown
231



Surface
333



Ceiling
343



Suspended
391

MODULE
Modulo

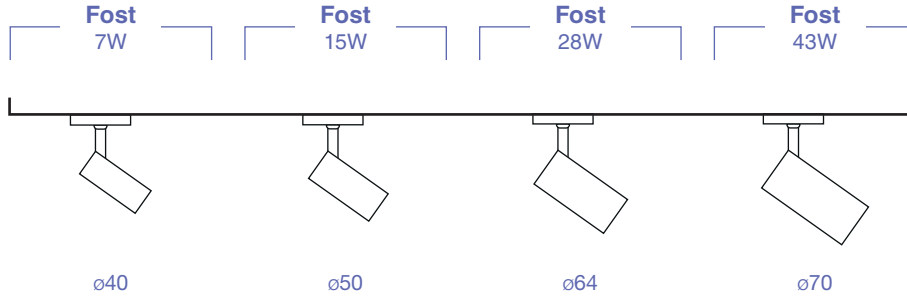

FINISH
Acabado

- **Black**
Negro
- **White**
Blanco

COLOR TEMPERATURE
Temperatura de color

2700K CRI90	3000K CRI90	4000K CRI90
2700K CRI97	3000K CRI97	4000K CRI97
MEAT	BREAD	FASHION

BEAM ANGLE
Ángulo de apertura

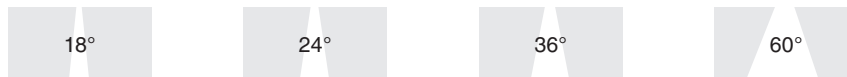

ACCESSORIES
Accesorios

- Honeycomb
- Striped Glass
- Spread Glass
- White Ring
- Copper Ring
- Snoot

CONTROL SYSTEM
Sistema de control



Highlights



Its wide range of sizes and optics makes it an ideal solution for commercial spaces, hotels, restaurants, retail and even domestic spaces due to its color temperature and CRI options.

Su versatilidad en tamaños y ópticas lo convierten en una solución ideal para espacios comerciales, hoteles, restaurantes, retail e incluso espacios domésticos por sus opciones en temperatura de color e IRC.



Different Sizes
Diversos Tamaños



Built-in Track
Equipo built-in en adaptador

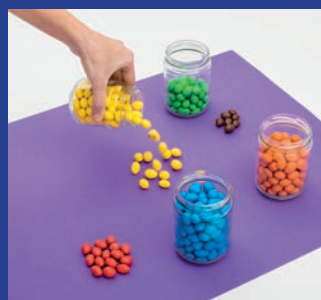

High CRI
Alto IRC

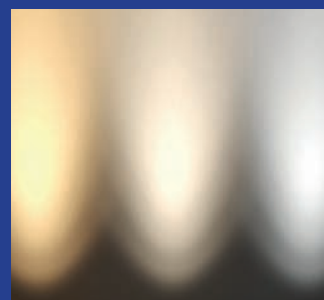

Several Color Temperatures
Varias Temperaturas de Color





White Ring
Anillo Blanco



Copper Ring
Anillo Cobre



Striped Glass
Vidrio Estriado



Long Snoot
Visera Larga

Its multiple accessories and combinations make it easy to personalize the product, allowing beam modification or glare reduction.

Sus múltiples accesorios y combinaciones facilitan la personalización del producto que hace posible la modificación de haz o reducir el deslumbramiento.



Spread Glass
Vidrio Difusor



Honeycomb
Panel de Abeja



Without Accessory



Spread Glass



Striped Glass

Accessories

	Honeycomb	White Ring	Copper Ring	Spread Glass	Long Snoot	Striped Glass
ø40	-	011500099	011500098	-	-	-
ø50	-	011600099	011600098	-	-	-
ø64	011700094	011700099	011700098	011700097	011700095	011700096
ø70	011800094	011800099	011800098	011800097	011800095	011800096

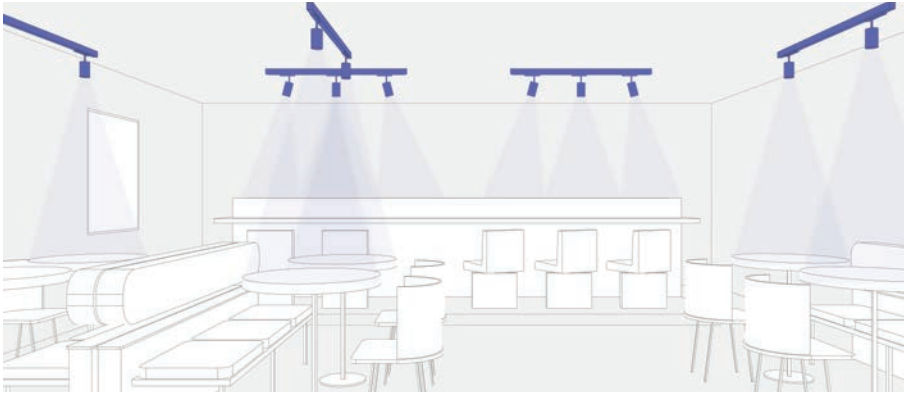

Restaurant

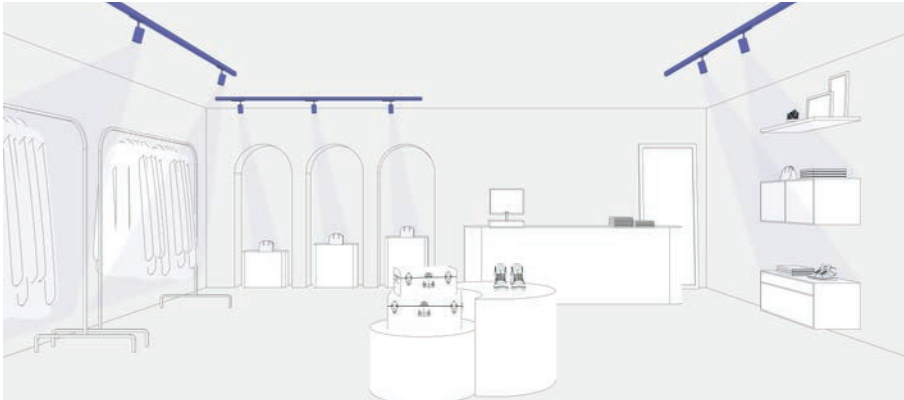

Retail

Beam Angle

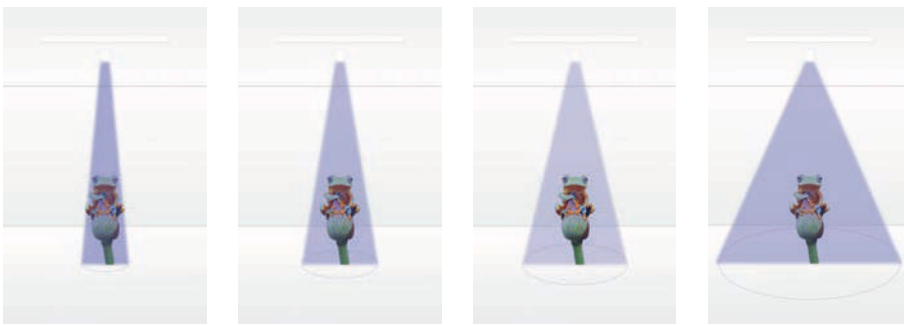

18°

24°

36°

60°

FOST TRACK 40

incl. DIM 355° 90° 50.000hs L70 / B10 MacAdam 2&3 220-240V 50 / 60Hz 650°C

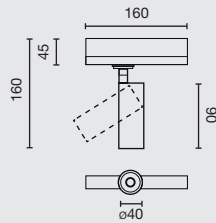

Family	Color T	Beam Angle	Finish	Control System
0115 Fost Track ø40 7W	927 2700K CRI90	1 18°	1 White	W CASAMBI
	930 3000K CRI90	2 24°	2 Black	D BALI
	940 4000K CRI90	3 36°		ON/OFF
	X27 2700K CRI97			
	X30 3000K CRI97			
	X40 4000K CRI97			

0115 927 1 1 W

Example **011592711W** — Fost Track ø40 7W 2700K CRI90 18° White Casambi

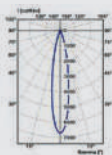

18°

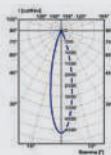

24°

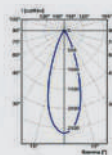

36°

Option	Color T	CRI	Power	Lumen Output	Beam Angle
927	2700K	90	7W	632lm / 553lm / 586lm	18° / 24° / 36°
X27		97	7W	569lm / 498lm / 527lm	18° / 24° / 36°
930	3000K	90	7W	652lm / 570lm / 604lm	18° / 24° / 36°
X30		97	7W	587lm / 513lm / 544lm	18° / 24° / 36°
940	4000K	90	7W	672lm / 587lm / 622lm	18° / 24° / 36°
X40		97	7W	604lm / 528lm / 560lm	18° / 24° / 36°

FOST TRACK 50

incl. DIM 355° 90° 50.000hs L80 / B10 MacAdam 2&3 220-240V 50 / 60Hz 650°C

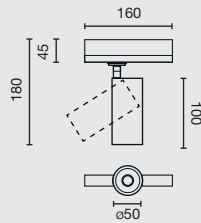

Family

Color T

Beam Angle

Finish

Control System

0116 Fost Track ø50 15W

- 927** 2700K CRI90
- 930** 3000K CRI90
- 940** 4000K CRI90
- X27** 2700K CRI97
- X30** 3000K CRI97
- X40** 4000K CRI97

- 1** 18°
- 2** 24°
- 3** 36°

- 1** White
- 2** Black

- W** CASAMBI
- D** DALI
- C** TRIAC
- ON/OFF

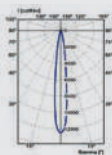

18°

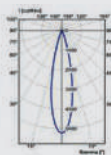

24°

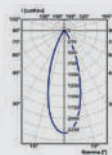

36°

Option	Color T	CRI	Power	Lumen Output	Beam Angle
927	2700K	90	15W	1025lm / 973lm / 988lm	18° / 24° / 36°
X27	2700K	97	15W	923lm / 876lm / 889lm	18° / 24° / 36°
930	3000K	90	15W	1057lm / 1003lm / 1019lm	18° / 24° / 36°
X30	3000K	97	15W	951lm / 903lm / 917lm	18° / 24° / 36°
940	4000K	90	15W	1089lm / 1033lm / 1050lm	18° / 24° / 36°
X40	4000K	97	15W	980lm / 930lm / 945lm	18° / 24° / 36°

FOST TRACK 64

incl. DIM 355° 90° 50.000hs L80 / B10 MacAdam 2&3 220-240V 50 / 60Hz 650°C

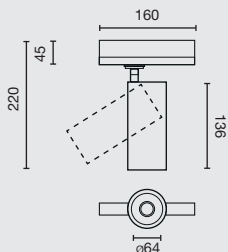

Family	Color T	Beam Angle	Finish	Control System								
0117 Fost Track ø64 28W	927 2700K CRI90	1 17° 2 25° 3 35° 6 60°	1 White	<table border="1"> <tr><td>W</td><td>CASAMBI</td></tr> <tr><td>D</td><td>BALI</td></tr> <tr><td>C</td><td>TRIAC</td></tr> <tr><td></td><td>ON/OFF</td></tr> </table>	W	CASAMBI	D	BALI	C	TRIAC		ON/OFF
	W		CASAMBI									
	D		BALI									
	C		TRIAC									
		ON/OFF										
	930 3000K CRI90	2 Black										
	940 4000K CRI90											
X27 2700K CRI97												
X30 3000K CRI97												
X40 4000K CRI97												

0117 927 1 1 W

Example 011592711W — Fost Track ø64 28W 2700K CRI90 17° White Casambi

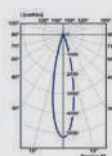

17°

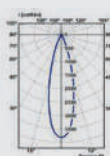

25°

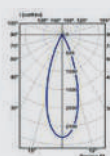

35°

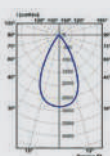

60°

Option	Color T	CRI	Power	Lumen Output	Beam Angle
927	2700K	90	28W	2982lm / 2987lm / 2732lm / 2270lm	17° / 25° / 35° / 60°
X27		97	28W	2684lm / 2688lm / 2459lm / 2043lm	17° / 25° / 35° / 60°
930	3000K	90	28W	3075lm / 3080lm / 2817lm / 2341lm	17° / 25° / 35° / 60°
X30		97	28W	2767lm / 2771lm / 2535lm / 2107lm	17° / 25° / 35° / 60°
940	4000K	90	28W	3167lm / 3172lm / 2902lm / 2412lm	17° / 25° / 35° / 60°
X40		97	28W	2850lm / 2855lm / 2611lm / 2170lm	17° / 25° / 35° / 60°

FOST TRACK 70

incl. DIM 355° 90° 50.000hs L70 / B10 MacAdam 2&3 220-240V 50 / 60Hz 650°C

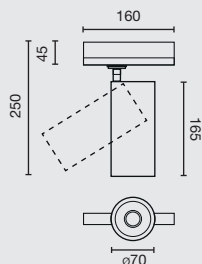

Family

Color T

Beam Angle

Finish

Control System

0118 Fost Track ø70 43W

- 927** 2700K CRI90
- 930** 3000K CRI90
- 940** 4000K CRI90
- X27** 2700K CRI97
- X30** 3000K CRI97
- X40** 4000K CRI97

- 1** 18°
- 2** 23°
- 3** 36°
- 6** 60°

- 1** White
- 2** Black

- W** CASAMBI
- D** DALI
- C** TRIAC
- ON/OFF**

- MT** MEAT
- BR** BREAD
- FS** FASHION

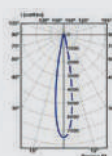

18°

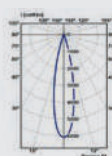

23°



36°



60°

Option	Color T	CRI	Power	Lumen Output	Beam Angle
927	2700K	90	43W	3428lm / 3400lm / 3369lm / 3294lm	18° / 23° / 36° / 60°
X27		97	43W	3085lm / 3059lm / 3032lm / 2964lm	18° / 23° / 36° / 60°
930	3000K	90	43W	3534lm / 3505lm / 3473lm / 3396lm	18° / 23° / 36° / 60°
X30		97	43W	3180lm / 3154lm / 3125lm / 3056lm	18° / 23° / 36° / 60°
940	4000K	90	43W	3640lm / 3610lm / 3577lm / 3498lm	18° / 23° / 36° / 60°
X40		97	43W	3276lm / 3249lm / 3219lm / 3148lm	18° / 23° / 36° / 60°
MT	-	-	43W	2165lm / 2149lm / 2140lm / 2052lm	18° / 23° / 36° / 60°
BR	-	-	43W	2921lm / 2899lm / 2888lm / 2769lm	18° / 23° / 36° / 60°
FS	-	-	43W	2998lm / 2976lm / 2964lm / 2842lm	18° / 23° / 36° / 60°



BLIT TRACK

BLIT TRACK is a versatile solution that provides flexibility and adaptability for various lighting applications. Designed to integrate into track lighting systems, it allows for precise light direction. Its elegant design enhances any environment and offers soft, ambient lighting that creates a cozy atmosphere.

BLIT TRACK es una solución versátil que proporciona flexibilidad y adaptabilidad para diversas aplicaciones de iluminación. Diseñado para integrarse en sistemas de iluminación en carril, permite dirigir la luz de manera precisa. Su diseño elegante realza cualquier entorno y ofrece una iluminación suave y ambiental que crea una atmósfera acogedora.

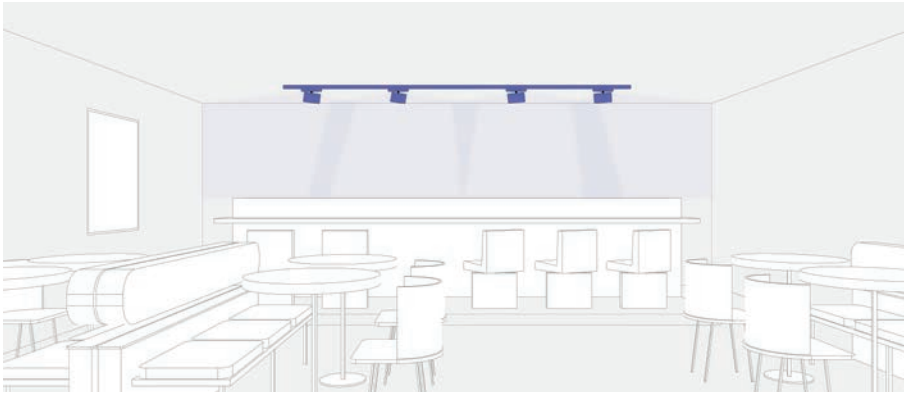

Restaurant

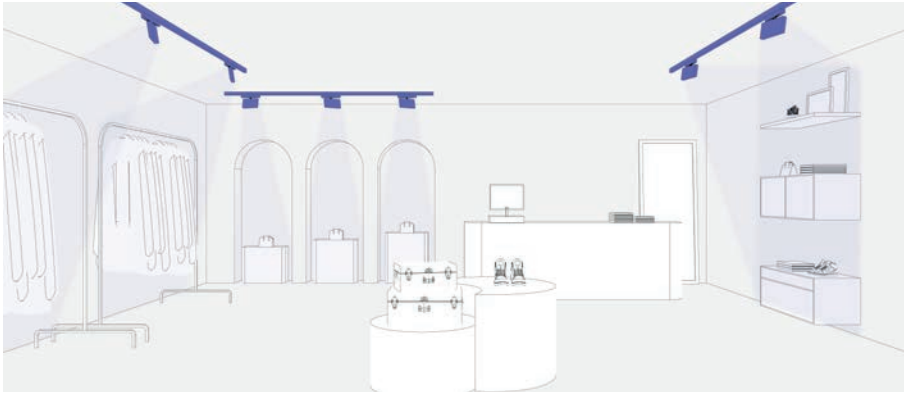

Retail

Beam Angle



Asym°

BLIT Collection



Surface

311

MODULE
Modulo

Blit 210mm
20W

Blit 300mm
33W

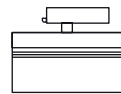

FINISH
Acabado

● **Black**
Negro

○ **White**
Blanco

COLOR TEMPERATURE
Temperatura de color

2700K CRI90

3000K CRI90

4000K CRI90

BEAM ANGLE
Ángulo de apertura

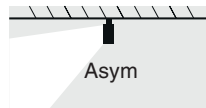

CONTROL SYSTEM
Sistema de control



CASAMBI

Highlights

Available in two power options and made entirely of aluminum and glass, BLIT TRACK provides general illumination through indirect light. Its minimalist design makes it perfect for complementing other track luminaires, such as projectors or linear lights, in environments like restaurants or commercial spaces.

Disponible en dos potencias, y fabricado íntegramente de aluminio y cristal, BLIT TRACK ofrece una iluminación general a través de luz indirecta. Su diseño minimalista lo hace perfecto para complementar otras luminarias de carril, como proyectores o luces lineales, en entornos como restaurantes o espacios comerciales.



High CRI
Alto IRC



High-quality materials
Materiales de alta calidad



Minimal design
Diseño minimalista

BLIT TRACK

incl. DIM 355° 30° 50.000hs L90 / B10 MacAdam 3 220-240V 50 / 60Hz 850°C

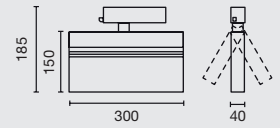
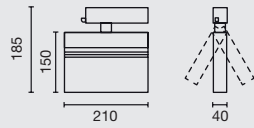

Family	Color T	Beam Angle	Finish	Control System
0127 Blit track 210mm 20W	927 2700K CRI90	9 Asym	1 White	W CASAMBI
0128 Blit track 300mm 33W	930 3000K CRI90		2 Black	D DALI
	940 4000K CRI90			ON/OFF

0127 **927** **9** **1** **D**

Example **012792791D** — Blit track 210mm 20W 2700K CRI90 White Dali

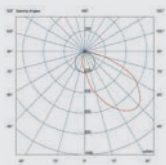

Asym

Option	Color T	CRI	Power	Lumen Output	Beam Angle
927	2700K	90	20w	1633	Asym
		90	33w	3412	Asym
930	3000K	90	20w	1684	Asym
		90	33w	3517	Asym
940	4000K	90	20w	1734	Asym
		90	33w	3623	Asym

VIA EVO TRACK is a linear luminaire designed to seamlessly integrate into three-phase track systems. When combined with our other track luminaires, it becomes an efficient solution for providing general lighting in various spaces. It offers three different color temperatures and also comes in Tuneable White and UGR versions, allowing for lighting adjustment to meet specific needs.

VIA EVO TRACK es una luminaria lineal diseñada para adaptarse perfectamente a sistemas de carriles trifásicos. Cuando se combina con otras de nuestras luminarias de carril, se convierte en una solución eficiente para proporcionar iluminación general en espacios diversos. Ofrece tres temperaturas de color diferentes, además de contar con versiones Tuneable White y UGR, lo que permite ajustar la iluminación y satisfacer necesidades específicas.



VIA

TRACK





VIA Collection



System
457

MODULE
Modulo

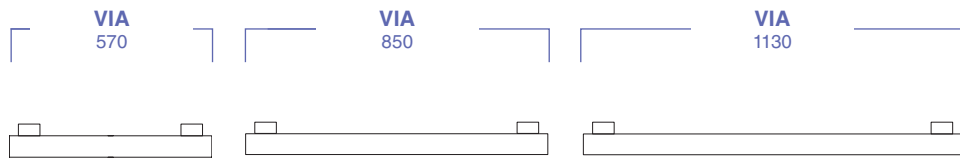

FINISH
Acabado

- Black**
Negro
- White**
Blanco

COLOR TEMPERATURE
Temperatura de color

- 3000K CRI80**
- 4000K CRI80**
- 2700-6500K**

DIFFUSER
Difusor

- Opal**
- Microprism**
- UGR**

CONTROL SYSTEM
Sistema de Control



CASAMBI

Highlights

Offering three different sizes and a variety of power options to adapt to the lighting needs of each space, VIA EVO TRACK is also available in UGR versions, ideal for office environments, and in Tunable White (TW) versions, designed to provide circadian cycle lighting in specific spaces.

Ofreciendo tres tamaños diferentes y una variedad de potencias para adaptarse a las necesidades lumínicas de cada espacio, VIA EVO TRACK también está disponible en versiones UGR, ideales para entornos de oficina, y en versiones TW, diseñadas para proporcionar iluminación de ciclo circadiano en espacios específicos.

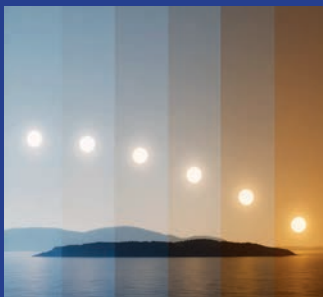

Tunable White



Different Sizes
Diversos Tamaños

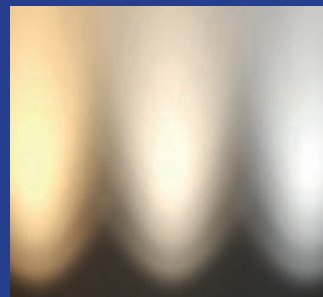

Several Color Temperatures
Varias Temperaturas de Color

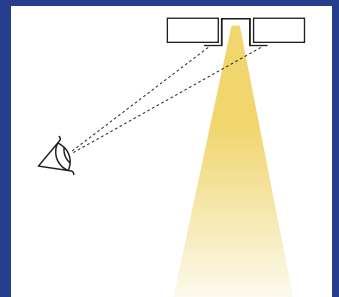

UGR<19

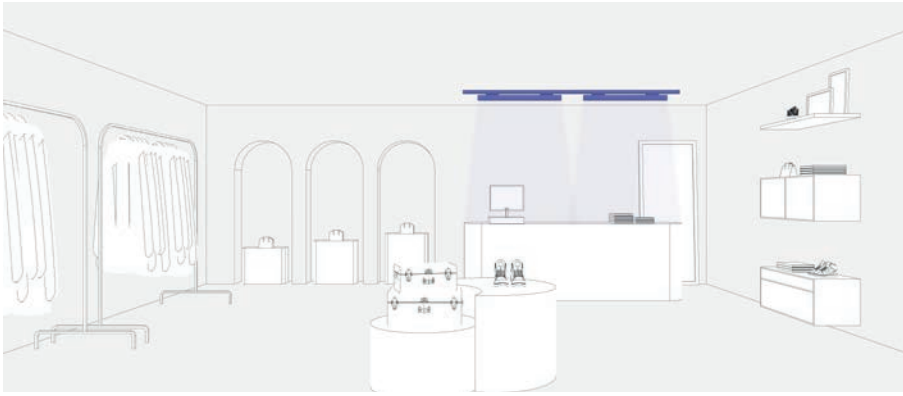

Retail



Office



Microprism

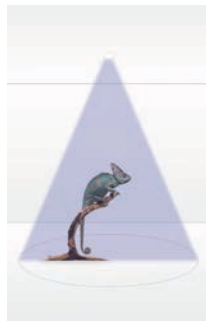

90°



Opal

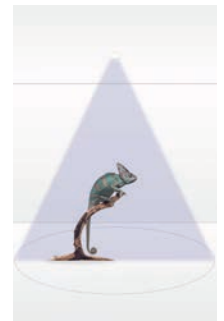

110°



UGR

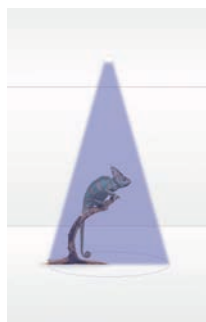

50°

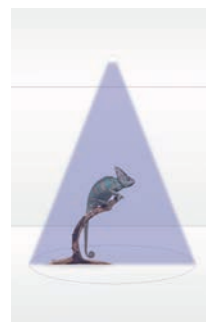

80°

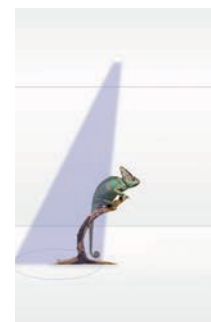

Asym°

VIA TRACK 570

incl. DIM 50.000hs L80/B10 MacAdam 3 TW 220-240V 50 / 60Hz 650°C

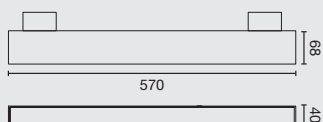

Family	Power	Finish	Control System	Diffuser
0410T Via Evo	590	Track 15W 3000K CRI80	W CASAMBI D DALI ON/OFF	Opal
	570	Track 25W 3000K CRI80		U Microprism
	680	Track 15W 4000K CRI80		
	660	Track 25W 4000K CRI80		
0410T Via Evo	010	Track 27W 2700-6500K TW	W CASAMBI DALI	Opal
				U Microprism

0410T 570 1 W

Example 0410T5701W — Via Evo Track 570 mm 25W 3000K Opal White

VIA TRACK 850

incl. DIM 50.000hs L80/B10 MacAdam 3 TW 220-240V 50 / 60Hz 650°C

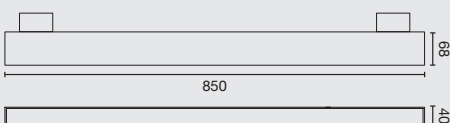

Family	Power	Finish	Control System	Diffuser
0410T Via Evo	560	Track 20W 3000K CRI80	W CASAMBI D DALI ON/OFF	Opal
	540	Track 38W 3000K CRI80		U Microprism
	650	Track 20W 4000K CRI80		
	630	Surface 38W 4000K CRI80		
0410T Via Evo	030	Track 39W 2700-6500K TW	W CASAMBI DALI	Opal
				U Microprism

VIA TRACK 1130

incl. DIM 50.000hs L80/B10 MacAdam 3 TW 220-240V 50 / 60Hz 650°C UGR 16

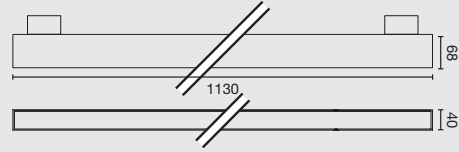

Family	Power	Finish	Control System	Diffuser
0410T Via Evo	530 Track 27W 3000K CRI80	1 White	W CASAMBI	Opal
	510 Track 51W 3000K CRI80	2 Black	D DALI	U Microprism
	620 Track 27W 4000K CRI80		ON/OFF	
	600 Track 51W 4000K CRI80			
0410T Via Evo	050 Track 48W 2700-6500K TW	1 White	W CASAMBI	Opal
		2 Black	D DALI	U Microprism
0410T Via Evo	110 Track UGR 32W 3000K CRI80	1 White	W CASAMBI	8 UGR<19 80°
	120 Track UGR 32W 4000K CRI80	2 Black	D DALI	5 UGR<16 50°
	111 Track UGR 17W 3000K CRI80		ON/OFF	0 UGR<19 asim.
	121 Track UGR 17W 4000K CRI80			
0410T Via Evo	010 Track UGR 54W 2700-6500K TW	1 White	W CASAMBI	8 UGR<19 80°
		2 Black	D DALI	5 UGR<16 50°
				0 UGR<19 asim.

VIA TRACK

570mm

Option	Color T	CRI	Difusor	Power	Lumen Output	Beam Angle
590	3000K	80	Opal / Microprism	15W	1392lm / 1133lm	110° / 90°
570		80	Opal / Microprism	25W	2506m / 2039m	110° / 90°
680	4000K	80	Opal / Microprism	15W	1434lm / 1167lm	110° / 90°
660		80	Opal / Microprism	25W	2581lm / 2100lm	110° / 90°
010	2700-6500K	TW	Opal / Microprism	27W	1964lm / 1598lm	110° / 90°

850mm

560	3000K	80	Opal / Microprism	20W	2131lm / 1735lm	110° / 90°
540		80	Opal / Microprism	38W	3809lm / 3121lm	110° / 90°
650	4000K	80	Opal / Microprism	20W	2195lm / 1787lm	110° / 90°
630		80	Opal / Microprism	39W	3923lm / 3214lm	110° / 90°
010	2700-6500K	TW	Opal / Microprism	39W	2985lm / 2429lm	110° / 90°

1130mm

530	3000K	80	Opal / Microprism	27W	2842lm / 2313lm	110° / 90°
510		80	Opal / Microprism	51W	5112lm / 4161lm	110° / 90°
620	4000K	80	Opal / Microprism	27W	2927lm / 2382lm	110° / 90°
600		80	Opal / Microprism	51W	5265lm / 4286lm	110° / 90°
050	2700-6500K	TW	Opal / Microprism	48W	4006lm / 3261lm	110° / 90°
110	3000K	80	UGR<16 / UGR<19	32W	3989lm / 4104lm / 3739lm	50° / 80° / Asym
120	4000K	80	UGR<16 / UGR<19	32W	4109lm / 4227lm / 3851lm	50° / 80° / Asym
010	2700-6500K	TW	UGR<16 / UGR<19	54W	4830lm / 4881lm / 4467lm	50° / 80° / Asym



How to install

CÓMO INSTALARLO

3Phase track, 16 A

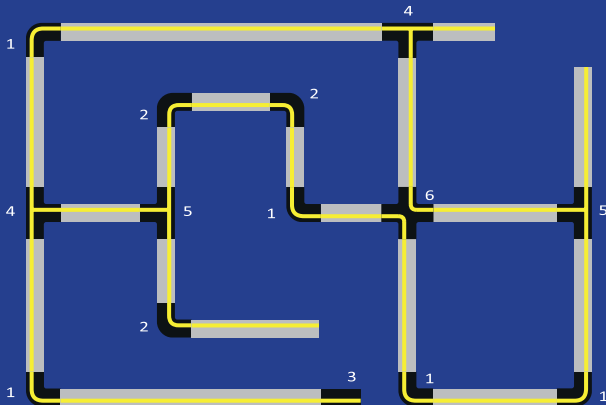

1 Outer "L" joint



2 Inner "L" joint



3 Outer live end



4 Outer "T"



5 Inner "T"



6 Cross joint

Connection sketch Esquema de conexiones

1 Circuit



N-conductor $i = 16$ A max

2 Circuit



N-conductor $i = 16$ A max

3 Circuit



$L1 + L2 + L3$ $i = 16$ A max

Recommended distance between fixing Distancia recomendada entre fijaciones

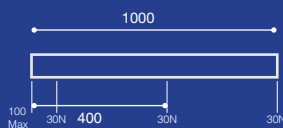

Max.Weight: 19,84 lb
Peso máx.: 9 kg

Max. 3 proyectores = 3,8 KVA
Máx. 3 proyectores = 3,8 KVA

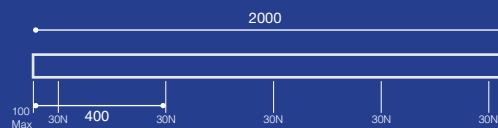

Max.Weight: 33,06 lb
Peso máx.: 15 kg

Max. 5 proyectores = 3,8 KVA
Máx. 5 proyectores = 3,8 KVA

3Phase Track

Compatible with IVELA & GLOBAL

ON/OFF

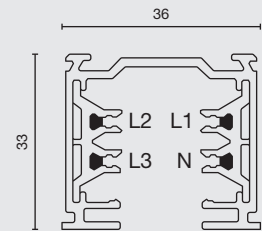
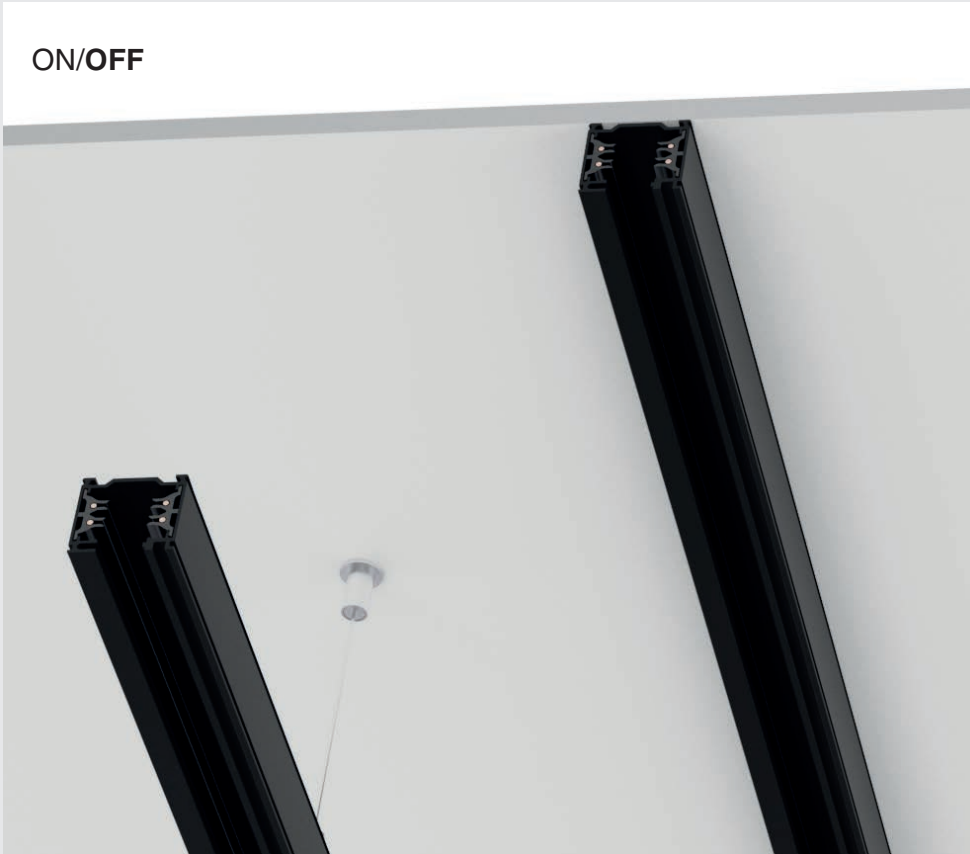

Surface & Suspended 3 phase track

01990101	● White	1000 mm
01990102	● Black	1000 mm
01990201	● White	2000 mm
01990202	● Black	2000 mm

Inner "L" Joint

	01990501	● White
	01990502	● Black

Intermediate Joint

	01990801	● White
	01990802	● Black

Inner live end

	01990601	● White
	01990602	● Black

Outer "L" Joint

	01990401	● White
	01990402	● Black

End cap

	01991101	● White
	01991102	● Black

Outer live end

	01990701	● White
	01990702	● Black

Outer "T"

	01990901	● White
	01990902	● Black

Flexible "L"

	01993201	● White
	01993202	● Black

Centre feed

	01993301	● White
	01993302	● Black

Inner "T"

	01991601	● White
	01991602	● Black

Pendant Kit 2000

	01990301	● White
	01990302	● Black

Ceiling kit 1piece

	01991201	● Aluminium
--	----------	-------------

Adapter / track connector

	01997001	● White
	01997002	● Black

Cross Joint

	01991001	● White
	01991002	● Black

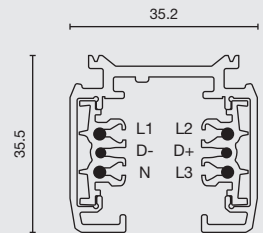

Surface & Suspended Dali track

01990101D	● White	1000 mm
01990102D	● Black	1000 mm
01990201D	● White	2000 mm
01990202D	● Black	2000 mm

Inner "L" Joint

	01990501D	● White
	01990502D	● Black

Flexible "L"

	01993201D	● White
	01993202D	● Black

Outer "L" Joint

	01990401D	● White
	01990402D	● Black

Pendant Kit 5000

	01990301D	● White
	01990302D	● Black

Dali inner live end

	01993501D	● White
	01993502D	● Black

Ceiling kit 1piece

	01991201D	● White
	01991202D	● Black

Adapter / track connector

	01997001D	● White
	01997002D	● Black

Dali outer live end

	01993601D	● White
	01993602D	● Black

Intermediate Joint

	01990801D	● White
	01990802D	● Black

Dali centre feed

	01993301D	● White
	01993302D	● Black

End cap

	01991101D	● White
	01991102D	● Black

ON/OFF

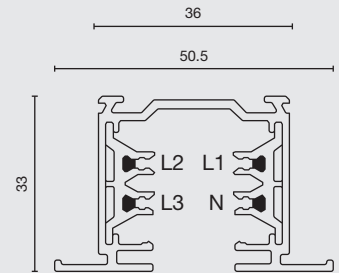

Recessed 3 phase track

01997101	● White	1000 mm
01997102	● Black	1000 mm
01997201	● White	2000 mm
01997202	● Black	2000 mm

Inner live end

	01997401	● White
	01997402	● Black

Outer live end

	01997301	● White
	01997302	● Black

Centre feed

	01997801	● White
	01997802	● Black

Intermediate Joint

	01997501	● White
	01997502	● Black

End cap

	01997701	● White
	01997702	● Black

Ceiling Kit 1piece

	01997601	● Aluminium
---	----------	-------------

Adapter / track connector

	01997001	● White
	01997002	● Black



R E C E

S S E D

The LINSE projector family stands out for its versatility and adaptability to various applications. Available in three configurations: 3-phase track, recessed, and Neso magnetic system version. This wide range offers flexible solutions for each project. It includes a standard projector and a varifocus version with adjustable beam angle to suit different environments. The framing projector is ideal for illuminating artwork or projecting logos, enhancing the identity of the space. LINSE also features LED THRIVE technology, delivering healthy, natural lighting that enhances colors and details with high quality.

La familia LINSE de proyectores se caracteriza por su versatilidad y adaptación a diversas aplicaciones. Disponible en versión track 3-phase, empotrable y para el sistema magnético Neso, ofrece soluciones flexibles para realzar espacios. Incluye un proyector estándar y otro varifocus con ángulo de haz ajustable, adaptando la luz al entorno. La versión de recorte es ideal para iluminar arte o proyectar logos, destacando la identidad del lugar. Además, LINSE incorpora tecnología LED THRIVE, que proporciona una iluminación saludable y natural, resaltando colores y detalles con alta calidad.

Designed by Faro Lab



NEW

LINSE



R E C E S S E D



LINSE Collection



Track
27



Neso Slim
450

MODULE

Modulo

Linse
10/20W

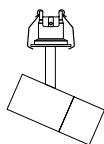

ø50

Linse Zoom
10/20W

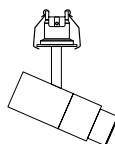

ø50

Linse Art
15W

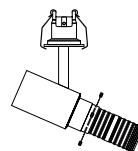

ø50

FINISH

Acabado

● **Black**
Negro

○ **White**
Blanco

COLOR TEMPERATURE

Temperatura de color

2700K CRI90

3000K CRI90

4000K CRI90

2700K THRIVE

3000K THRIVE

4000K THRIVE

BEAM ANGLE

Ángulo de apertura

15°

24°

36°

50°

ACCESSORIES

Accesorios



White Ring



Gold Ring



Honeycomb



Striped Glass



Long Snoot



Cinema

CONTROL SYSTEM

Sistema de control



CASAMBI

LINSE RECESSED



- incl.
- DIM
- 355°
- 90°
- 50.000hs L80 / B10
- MacAdam 2&3
- 220-240V
- 650°C

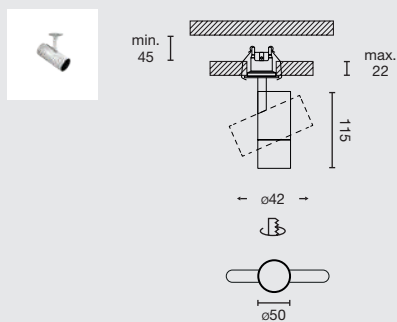

Family	Color T	Beam Angle	Finish	Control System
0390 Linse Recessed	1 10W	1 15°	1 White	W CASAMBI D DALI ON/OFF
	2 20W		2 24°	
	927 2700K CRI90	3 36°	2 Black	
	930 3000K CRI90	5 50°		
	940 4000K CRI90			
	T27 2700K THRIVE			
	T30 3000K THRIVE			
	T40 4000K THRIVE			

0390 1 927 1 1 W

Example 0390192711W — Linse Recessed ø50 10W 2700K CRI90 15° White Casambi

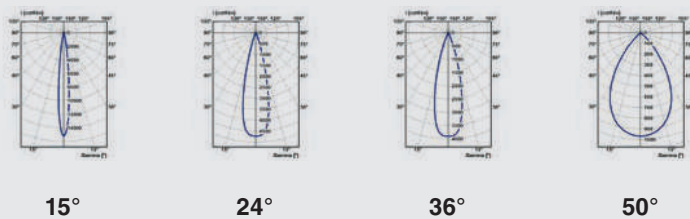

Option	Color T	CRI	Power	Lumen Output	Beam Angle
927	2700K	90	10W	771 / 968 / 967 / 944	15° / 24° / 36° / 50°
T27		THRIVE	10W	681 / 855 / 854 / 833	15° / 24° / 36° / 50°
930	3000K	90	10W	795 / 998 / 997 / 973	15° / 24° / 36° / 50°
T30		THRIVE	10W	702 / 881 / 880 / 859	15° / 24° / 36° / 50°
940	4000K	90	10W	819 / 1028 / 1027 / 1002	15° / 24° / 36° / 50°
T40		THRIVE	10W	722 / 907 / 906 / 884	15° / 24° / 36° / 50°
927	2700K	90	20W	1309 / 1643 / 1641 / 1602	15° / 24° / 36° / 50°
T27		THRIVE	20W	1154 / 1449 / 1448 / 1414	15° / 24° / 36° / 50°
930	3000K	90	20W	1349 / 1694 / 1692 / 1651	15° / 24° / 36° / 50°
T30		THRIVE	20W	1190 / 1494 / 1492 / 1456	15° / 24° / 36° / 50°
940	4000K	90	20W	1389 / 1745 / 1742 / 1701	15° / 24° / 36° / 50°
T40		THRIVE	20W	1226 / 1539 / 1537 / 1500	15° / 24° / 36° / 50°

LINSE ZOOM RECESSED

NEW

incl. DIM 355° 90° 50.000hs L80 / B10 MacAdam 2&3 220-240V 650°C

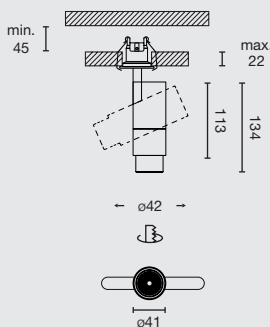

Family	Color T	Beam Angle	Finish	Control System
0390 Linse Zoom Recessed	1 10W	6 20°- 50°	1 White	W CASAMBI D DALI ON/OFF
	2 20W		2 Black	
	927 2700K CRI90			
	930 3000K CRI90			
	940 4000K CRI90			
	T27 2700K THRIVE			
	T30 3000K THRIVE			
	T40 4000K THRIVE			

0390 1 927 6 1 W

Example 0390192761W — Linse Zoom Recessed ø50 10W 2700K CRI90 20° White Casambi

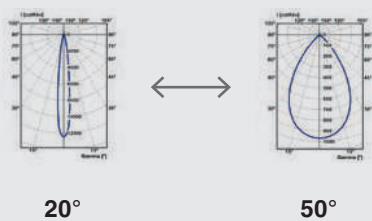

Option	Color T	CRI	Power	Lumen Output	Beam Angle
927	2700K	90	10W	254 / 382	20° to 50°
T27		THRIVE	10W	246 / 370	20° to 50°
930	3000K	90	10W	262 / 393	20° to 50°
T30		THRIVE	10W	217 / 327	20° to 50°
940	4000K	90	10W	232 / 350	20° to 50°
T40		THRIVE	10W	225 / 239	20° to 50°
927	2700K	90	20W	415 / 624	20° to 50°
T27		THRIVE	20W	403 / 605	20° to 50°
930	3000K	90	20W	427 / 643	20° to 50°
T30		THRIVE	20W	356 / 534	20° to 50°
940	4000K	90	20W	376 / 567	20° to 50°
T40		THRIVE	20W	366 / 551	20° to 50°

LINSE ART RECESSED NEW

incl. DIM 355° 90° 50.000hs L80 / B10 MacAdam 2&3 220-240V 650°C

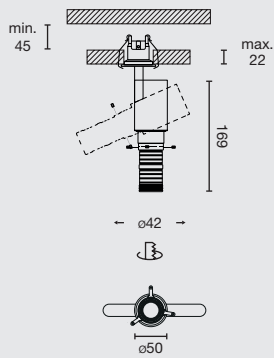

Family	Color T	Beam Angle	Finish	Control System
--------	---------	------------	--------	----------------

0390 Linse Art Recessed 1 15W	927 2700K CRI90	7 Framer Spot	1 White	W CASAMBI D BALI ON/OFF
	930 3000K CRI90		2 Black	
	940 4000K CRI90			
	T27 2700K THRIVE			
	T30 3000K THRIVE			
	T40 4000K THRIVE			

0390 **1** **927** **7** **1** **W**

Example **0390192771W** — Linse Art Recessed ø50 15W 2700K CRI90 White Casambi

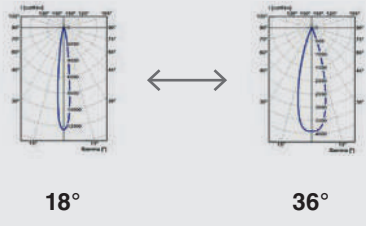

Option	Color T	CRI	Power	Lumen Output	Beam Angle
927	2700K	90	15W	163 / 306	18° to 36°
T27		THRIVE	15W	160 / 300	18° to 36°
930	3000K	90	15W	168 / 315	18° to 36°
T30		THRIVE	15W	141 / 265	18° to 36°
940	4000K	90	15W	149 / 278	18° to 36°
T40		THRIVE	15W	144 / 270	18° to 36°





KIRA Pinhole is a technical luminaire for discreet architectural integration, offering fixed or adjustable options with static or directional light. Its deeply recessed optics ensure clean, glare-free illumination, while optional IP65 protection and a honeycomb accessory enhance visual comfort. With CRI90 for high color accuracy, KIRA is a compact, precise, and refined lighting solution.

KIRA Pinhole es una luminaria técnica para integración arquitectónica discreta, disponible en versión fija u orientable con luz estática o direccionable. Su óptica empotrada garantiza una iluminación limpia y sin deslumbramiento, con opción de protección IP65 y accesorio panel de abeja para mayor confort visual. Con CRI90, KIRA ofrece una solución compacta, precisa y depurada.

KIRBA



P I N H O L E



MODULE
Modulo

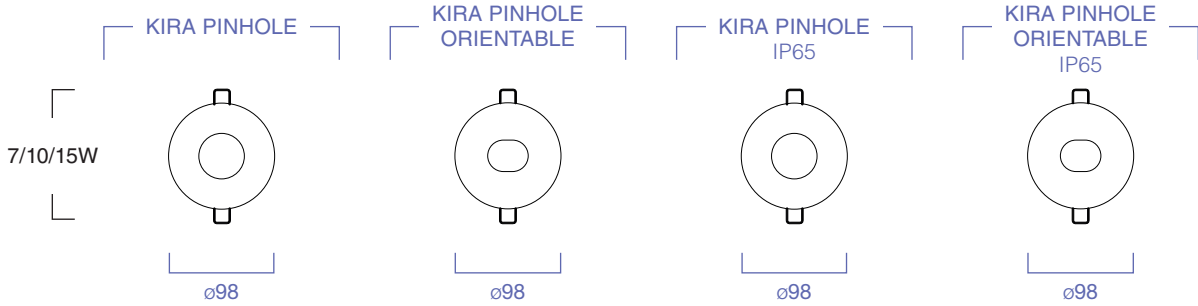

FINISH
Acabado

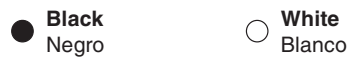

COLOR TEMPERATURE
Temperatura de color

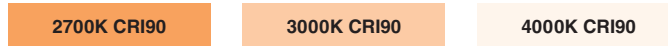

BEAM ANGLE
Ángulo de apertura



CONTROL SYSTEM
Sistema de control



CASAMBI



Highlights

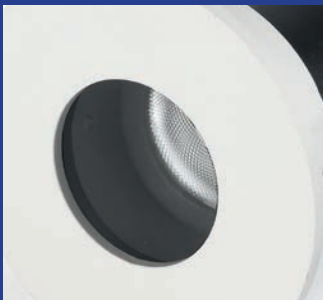

Optional IP65
Opción IP65



Adjustable Version
Versión Orientable



Honeycomb
Panal de abeja



Several color temperatures
Varias temperaturas de color

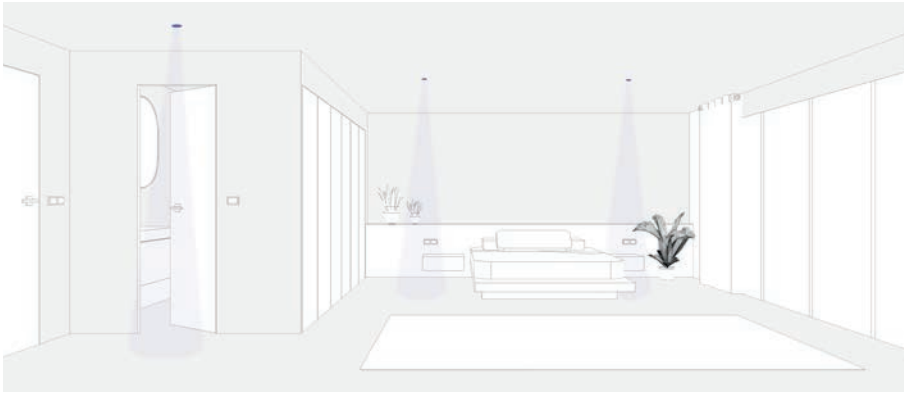

Hotel Room



Office

Beam Angle

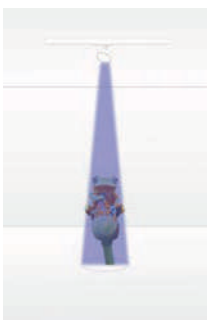

12°



24°

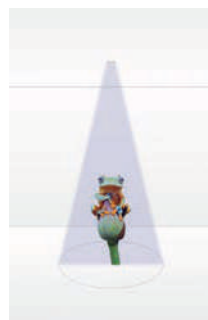

36°

KIRA PINHOLE

NEW

incl. DIM 50.000hs L70 / B10 MacAdam 3 220-240V 650°C

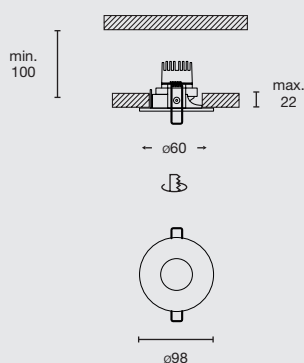

Family	IP	Power	Color T	Beam Angle	Finish	Control System
0374 Kira Pinhole	2 IP20	6 7W	927 2700K CRI90	1 15°	1 White	W CASAMBI
	6 IP65	1 10W	930 3000K CRI90	2 24°	2 Black	D BALI
		5 15W	940 4000K CRI90	3 36°		C TRIAC ON/OFF

0374 2 6 0374 927 1 1 1 W

Example 03742692711W — Kira Pinhole IP20 7W 2700K CRI90 15° White Casambi

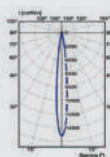

15°

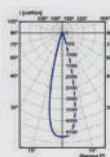

24°

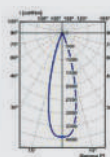

36°

Option	Color T	CRI	Power	Lumen Output	Beam Angle
927	2700K	90	7W	374 / 454 / 497 / 432	15° / 24° / 36°
			10W	575 / 698 / 765 / 664	15° / 24° / 36°
			15W	713 / 866 / 948 / 823	15° / 24° / 36°
930	3000K	90	7W	386 / 468 / 512 / 445	15° / 24° / 36°
			10W	593 / 719 / 789 / 685	15° / 24° / 36°
			15W	735 / 892 / 978 / 848	15° / 24° / 36°
940	3000K	90	7W	397 / 482 / 528 / 458	15° / 24° / 36°
			10W	611 / 741 / 812 / 705	15° / 24° / 36°
			15W	757 / 919 / 1006 / 874	15° / 24° / 36°

KIRA PINHOLE ORIENTABLE

NEW

incl. DIM 30° 50.000hs L70 / B10 MacAdam 3 220-240V 650°C

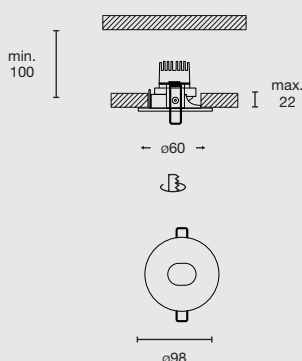
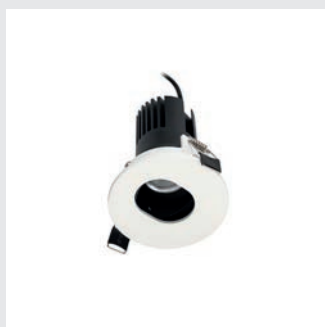

Family	IP	Power	Color T	Beam Angle	Finish	Control System
0375 Kira Pinhole Orientable	2 IP20	6 7W	927 2700K CRI90	1 15°	1 White	W CASAMBI D DALI C TRIAC ON/OFF
	6 IP65	1 10W	930 3000K CRI90	2 24°	2 Black	
		5 15W	940 4000K CRI90	3 36°		

0375 2 6 927 1 1 1 W

Example **03752692711W** — Kira Pinhole Orientable IP20 7W 2700K CRI90 15° White Casambi

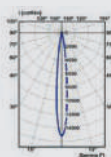

15°

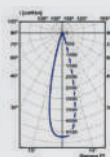

24°

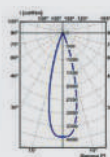

36°

Option	Color T	CRI	Power	Lumen Output	Beam Angle
927	2700K	90	7W	384 / 535 / 567 / 482	15° / 24° / 36°
			10W	591 / 823 / 872 / 742	15° / 24° / 36°
			15W	733 / 1021 / 1082 / 920	15° / 24° / 36°
930	3000K	90	7W	396 / 552 / 585 / 497	15° / 24° / 36°
			10W	609 / 847 / 897 / 764	15° / 24° / 36°
			15W	756 / 1052 / 1110 / 946	15° / 24° / 36°
940	3000K	90	7W	408 / 568 / 602 / 512	15° / 24° / 36°
			10W	627 / 874 / 925 / 787	15° / 24° / 36°
			15W	779 / 1084 / 1148 / 976	15° / 24° / 36°

ELIOS

The ELIOS downlight family is designed to offer versatility and efficiency in any space. With three available power options and an IP54 rating, this family adapts to a variety of needs. Its range of reflectors, from simple fixed models to versions with decorative details, allows for customization according to the environment. Equipped with the latest LED technology, ELIOS ensures superior energy performance. Additionally, the range includes adjustable versions, wallwashers, and both single and double trims, providing complete solutions for any architectural project.

La familia de downlights ELIOS ha sido diseñada para ofrecer versatilidad y eficiencia en cualquier espacio. Con tres potencias disponibles y la opción de IP54, esta familia se adapta a diversas necesidades. Su variedad de reflectores, que van desde el simple fijo hasta versiones con detalles decorativos, permiten personalizar el diseño según el ambiente. Equipados con la última tecnología LED, los ELIOS garantizan un rendimiento energético superior. Además, la gama incluye versiones orientables, wallwasher y marcos tanto individuales como dobles, ofreciendo soluciones completas para cualquier proyecto arquitectónico.

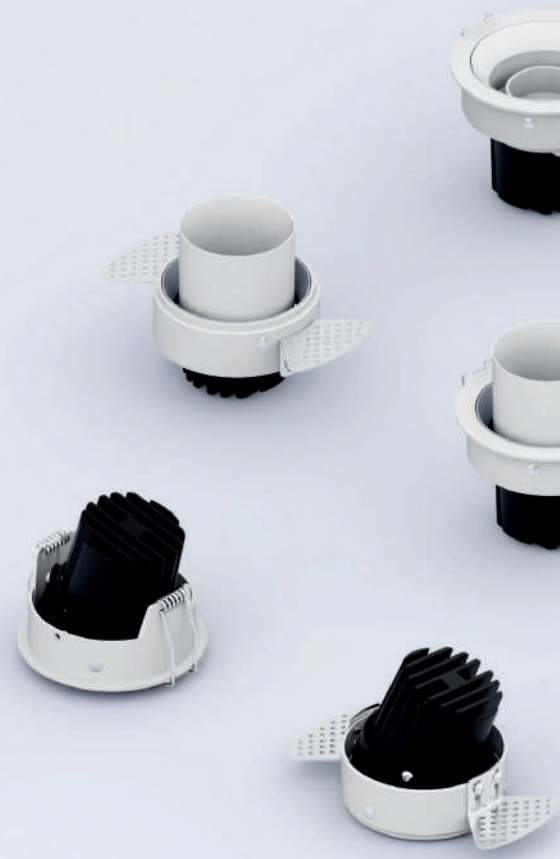





MODULE
Modulo

ELIOS
Fix Module



ø72/82

ELIOS
Ori Module



ø72/82

ELIOS
Tube Module



ø72/82

7W/10W/15W

ELIOS
Bell Module

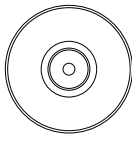

ø105

ELIOS
Wallwisher Module

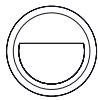

ø72/82

ELIOS
Art Module



ø50

FINISH
Acabado

● **Black**
Negro

○ **White**
Blanco

COLOR TEMPERATURE
Temperatura de color

2700K CRI90

3000K CRI90

4000K CRI90

2400-6500K THRIVE

BEAM ANGLE
Ángulo de apertura

15°

24°

36°

50°

ACCESSORIES
Accesorios



Honeycomb



Striped glass



Woven glass

CONTROL SYSTEM
Sistema de control



CASAMBI



Highlights

ELIOS incorporates LED technology that offers a balance between visual comfort and high efficiency, maintaining a CRI 90 thanks to the use of next-generation LEDs. Additionally, it includes the Tunable White (TW) option with Thrive technology, which promotes a focus on healthy lighting. All variants are available with IP20 and IP54 protection ratings.

ELIOS incorpora una tecnología LED que ofrece un equilibrio entre confort visual y alta eficiencia, manteniendo un ICR 90 gracias al uso de LEDs de última generación. Además, cuenta con la opción TW con tecnología Thrive, que promueve un enfoque hacia una iluminación saludable. Todas las variantes están disponibles con grados de protección IP20 e IP54.



High Efficiency
Alta eficiencia

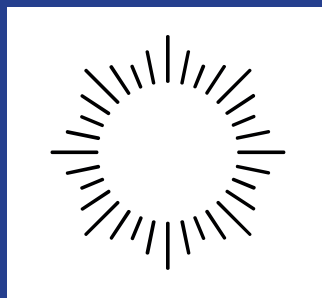

Thrive Technology
Tecnología Thrive



Tunable White



Optional IP54
Opción IP54

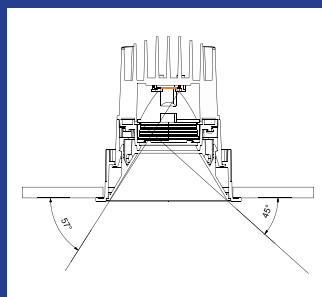

Visual Comfort
Confort visual



Tube Version
Versión Tube





Trim White
Marco blanco



Trim Black
Marco negro



Trimless
Sin marco



Double White
Doble marco blanco



Double Black
Doble marco negro



Double Trimless White
Sin marco doble blanco



Double Trimless Black
Sin marco doble negro



Honeycomb
Panel de abeja



Woven Glass
Vidrio trenzado



Striped Glass
Vidrio estriado

Accessories

Honeycomb 0700PP001	Woven Galss 0700PP002	Striped Glass 0700PP003	Trimless 0700PP0301	Trim White 0700PP0303
Trim Black 0700PP0304	Double White 0700PP0305	Double Black 0700PP0306	Double Trimless White 0700PP0307	Double Trimless Black 0700PP0308

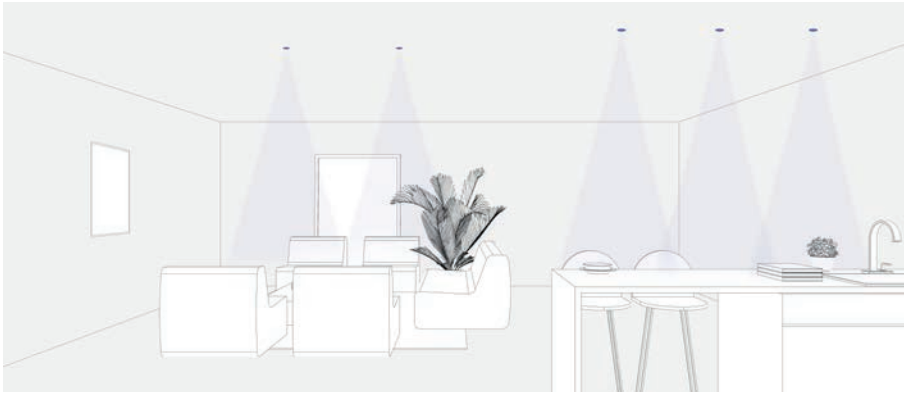

Residential



Hotel



Restaurant

Beam Angle

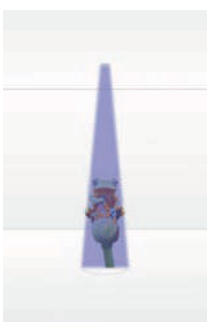

15°

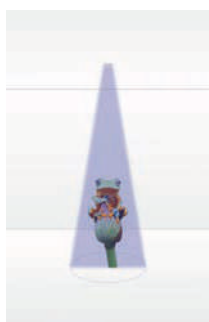

24°

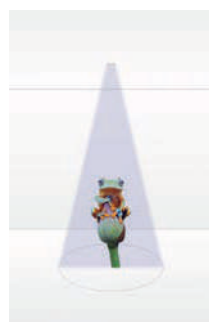

36°

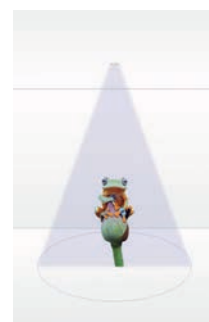

50°

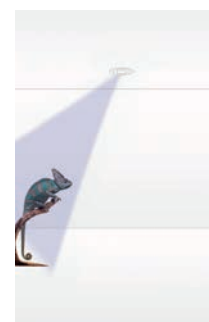

Asym°

ELIOS FIX MODULE



1. CONFIGURE YOUR MODULE



7W / 10W

15W

Family	IP	Power	Color T	Beam Angle	Finish	Control System
0700 Elios Fix Module	2 IP20	7 7W	927 2700K CRI90	1 15°	1 White	W CASAMBI
	5 IP54	1 10W	930 3000K CRI90	2 24°	2 Black	D DALI
		5 15W	940 4000K CRI90	3 36°		C TRIAC
				5 50°		ON/OFF
		7 7W	TW 2400-6500K THRIVE			W CASAMBI
						D DALI

Example **07002792711W** — Elios Fix Module IP20 7W 2700K CRI90 15° White Casambi

2. CHOOSE YOUR TRIM



3. FINAL CONFIGURATIONS OF MODULES AND TRIMS

Examples of combinations module + trim

Individual Module



Double Module

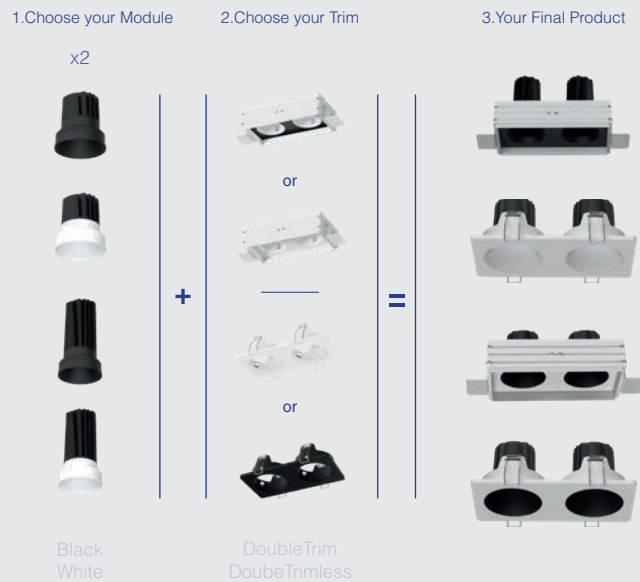

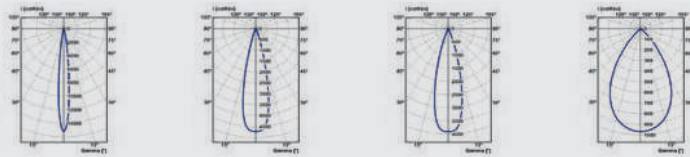
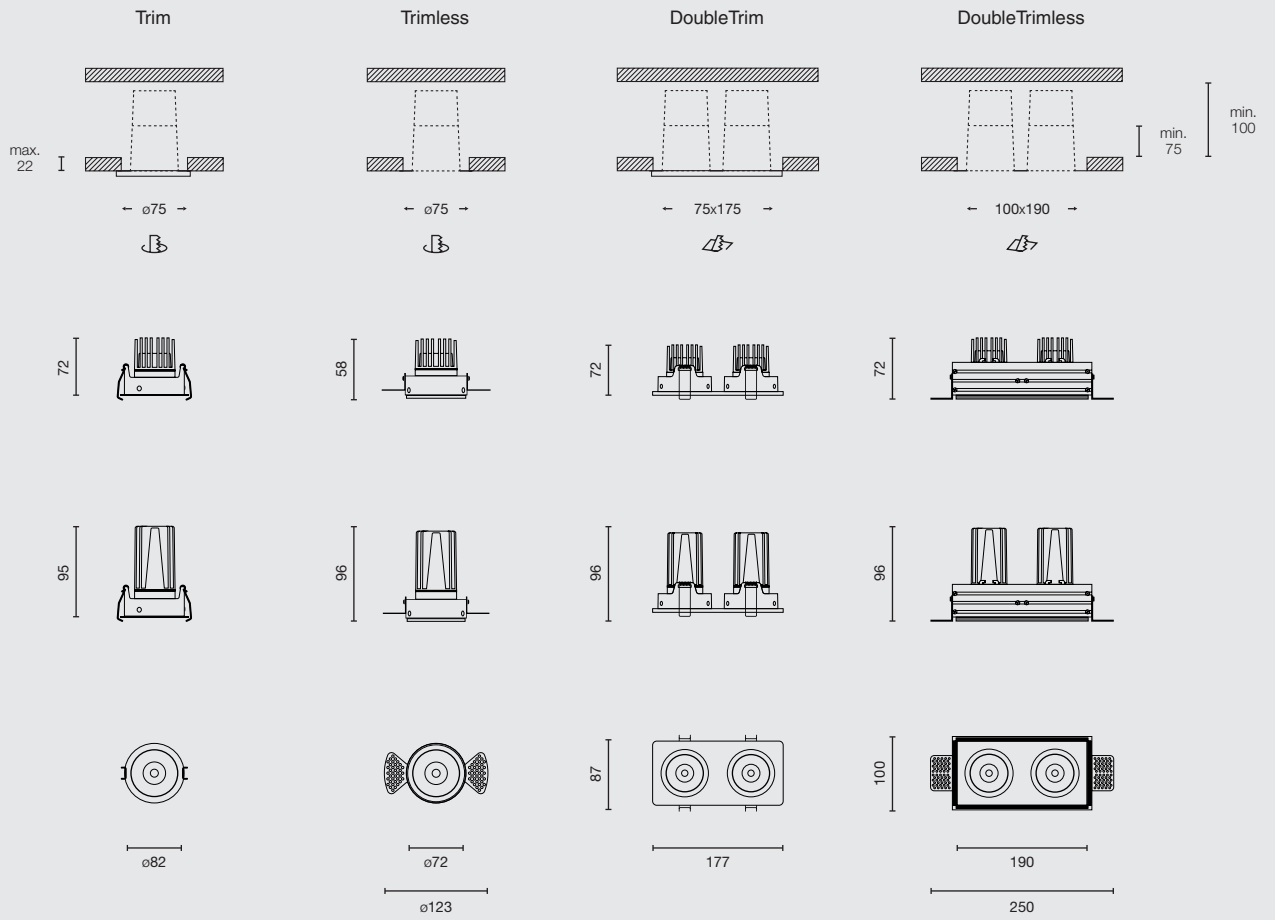

15°

24°

36°

50°

Option	Color T	CRI	Power	Lumen Output	Beam Angle
927	2700K	90	7W	299 / 436 / 474 / 454	15° / 24° / 36° / 50°
			10W	460 / 671 / 729 / 698	15° / 24° / 36° / 50°
			15W	570 / 832 / 904 / 866	15° / 24° / 36° / 50°
930	3000K	90	7W	308 / 449 / 489 / 467	15° / 24° / 36° / 50°
			10W	474 / 692 / 752 / 719	15° / 24° / 36° / 50°
			15W	588 / 858 / 932 / 893	15° / 24° / 36° / 50°
940	4000K	90	7W	318 / 463 / 503 / 480	15° / 24° / 36° / 50°
			10W	488 / 713 / 774 / 740	15° / 24° / 36° / 50°
			15W	606 / 884 / 960 / 919	15° / 24° / 36° / 50°
TW	2700K-6500K	THRIVE	7W	611lm / 630lm / 679lm / 655lm	15° / 24° / 36° / 50°

ELIOS ORIENTABLE MODULE

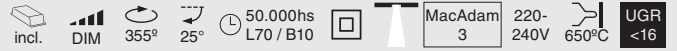

1.CONFIGURE YOUR MODULE



7W / 10W

15W

Family	IP	Power	Color T	Beam Angle	Finish	Control System
0701 Elios Orientable Module	2 IP20	7 7W	927 2700K CRI90	1 15°	1 White	W CASAMBI
	5 IP54	1 10W	930 3000K CRI90	2 24°	2 Black	D BALI
		5 15W	940 4000K CRI90	3 36°		C TRIAC
				5 50°		ON/OFF
		7 7W	TW 2400-6500K THRIVE			W CASAMBI
						D BALI

0701 2 7 927 1 1 W

07012792711W — Elios Orientable Module IP20 7W 2700K CRI90 15° White Casambi

2.CHOOSE YOUR TRIM



3.FINAL CONFIGURATIONS OF MODULES AND TRIMS

Examples of combinations module + trim

Individual Module

1.Choose your Module 2.Choose your Trim 3.Your Final Product



Double Module

1.Choose your Module 2.Choose your Trim 3.Your Final Product

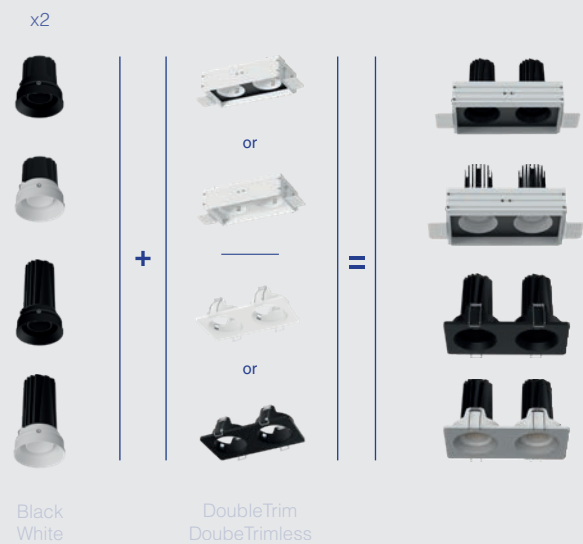

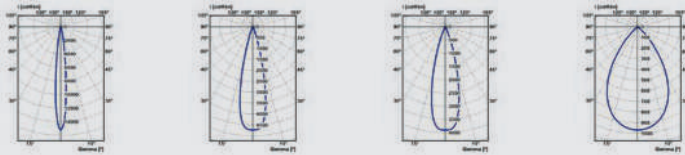
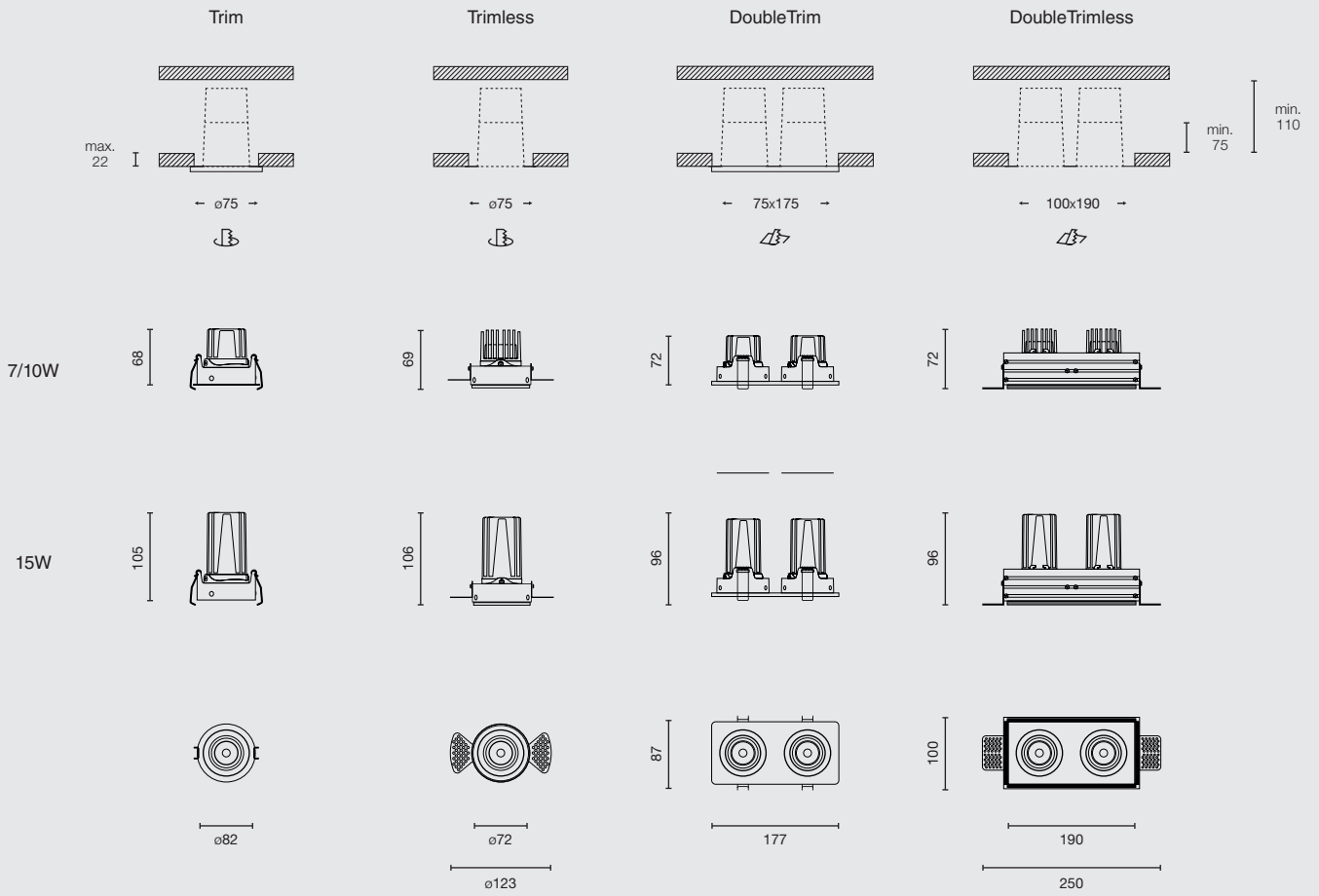

15°

24°

36°

50°

Option	Color T	CRI	Power	Lumen Output	Beam Angle
927	2700K	90	7W	278 / 416 / 456 / 446	15° / 24° / 36° / 50°
			10W	428 / 640 / 702 / 686	15° / 24° / 36° / 50°
			15W	530 / 794 / 870 / 851	15° / 24° / 36° / 50°
930	3000K	90	7W	287 / 429 / 470 / 460	15° / 24° / 36° / 50°
			10W	441 / 659 / 723 / 706	15° / 24° / 36° / 50°
			15W	546 / 819 / 897 / 878	15° / 24° / 36° / 50°
940	4000K	90	7W	296 / 442 / 484 / 474	15° / 24° / 36° / 50°
			10W	454 / 678 / 744 / 727	15° / 24° / 36° / 50°
			15W	562 / 843 / 924 / 904	15° / 24° / 36° / 50°
TW	2700K-6500K	THRIVE	7W	522lm / 639lm / 660lm / 619lm	15° / 24° / 36° / 50°

ELIOS TUBE MODULE

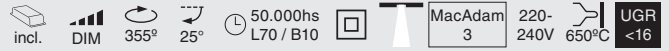

1.CONFIGURE YOUR MODULE



7W / 10W

15W

Family	IP	Power	Color T	Beam Angle	Finish	Control System	
0702 Elios Tube Module	2 IP20	7 7W	927 2700K CRI90	1 15°	1 White	W CASAMBI	
		1 10W	930 3000K CRI90	2 24°	2 Black	D BALI	
		5 15W	940 4000K CRI90	3 36°		C TRIAC	
					5 50°		ON/OFF
			7 7W	TW 2400-6500K THRIVE			W CASAMBI
							D BALI

07022792711W — Elios Tube Module IP20 7W 2700K CRI90 15° White Casambi

2.CHOOSE YOUR TRIM



3.FINAL CONFIGURATIONS OF MODULES AND TRIMS

Examples of combinations module + trim

Individual Module



Double Module

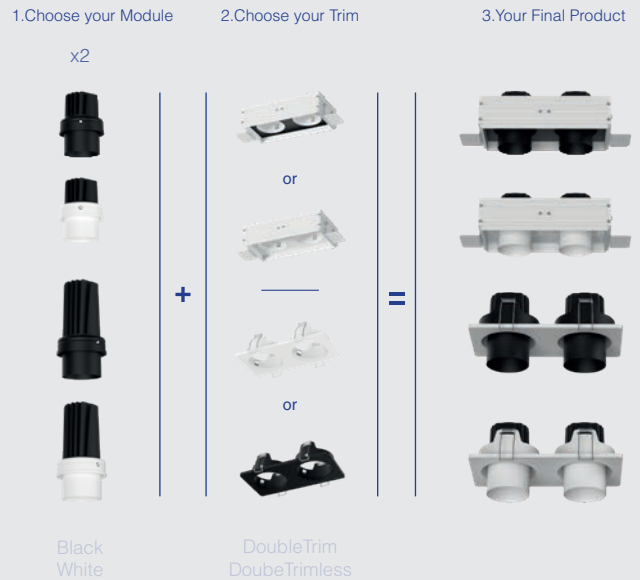

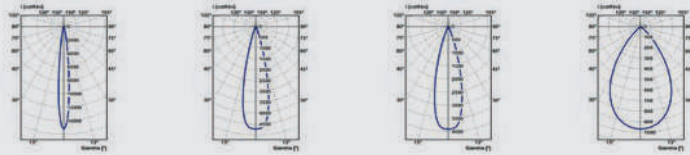
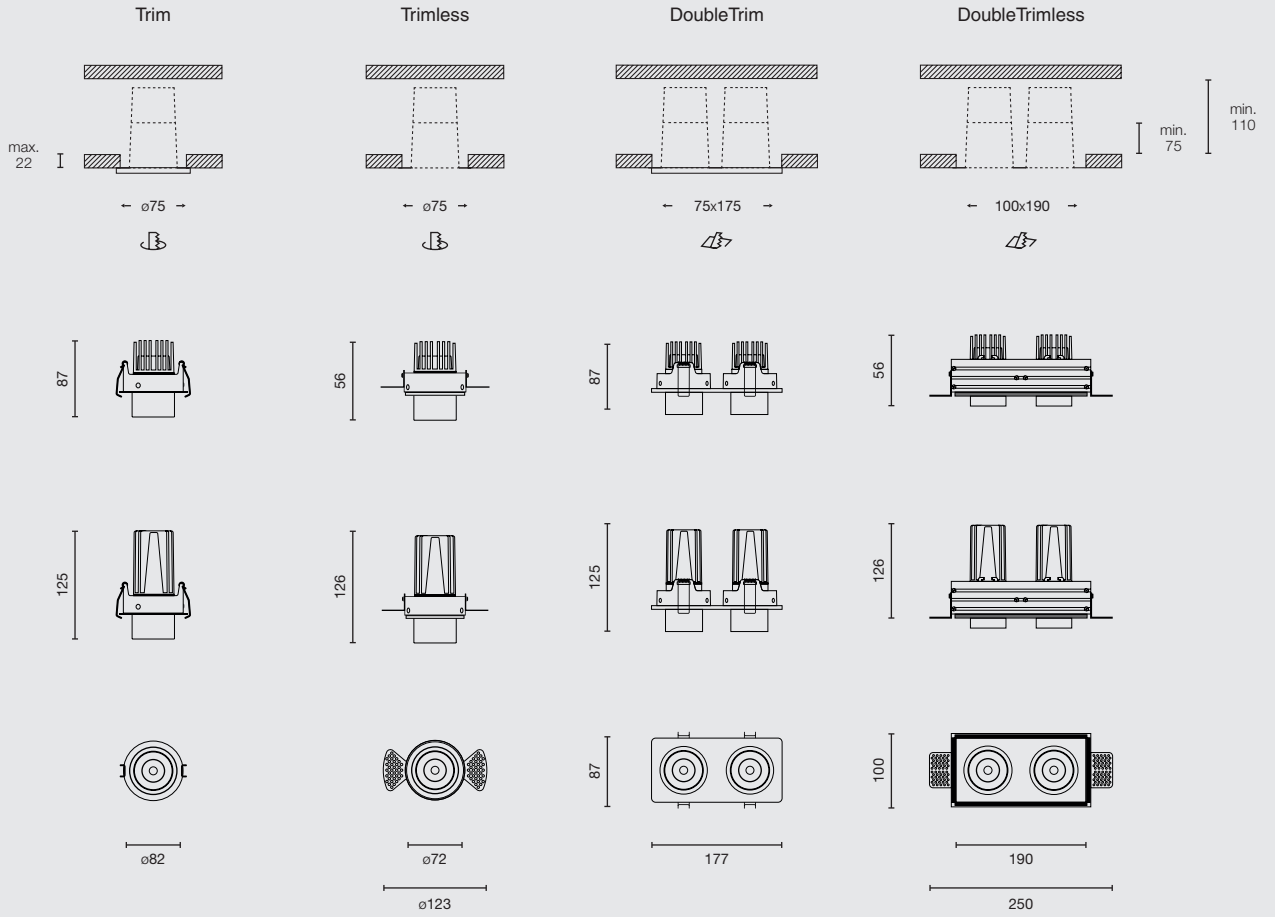

15°

24°

36°

50°

Option	Color T	CRI	Power	Lumen Output	Beam Angle
927	2700K	90	7W	292 / 405 / 443 / 364	15° / 24° / 36° / 50°
			10W	449 / 623 / 682 / 560	15° / 24° / 36° / 50°
			15W	557 / 773 / 845 / 694	15° / 24° / 36° / 50°
930	3000K	90	7W	301 / 417 / 456 / 376	15° / 24° / 36° / 50°
			10W	463 / 642 / 703 / 576	15° / 24° / 36° / 50°
			15W	574 / 797 / 871 / 716	15° / 24° / 36° / 50°
940	4000K	90	7W	310 / 429 / 470 / 387	15° / 24° / 36° / 50°
			10W	477 / 661 / 724 / 592	15° / 24° / 36° / 50°
			15W	591 / 821 / 897 / 737	15° / 24° / 36° / 50°
TW	2700K-6500K	THRIVE	7W	456lm / 560lm / 605lm / 513lm	15° / 24° / 36° / 50°

ELIOS BELL MODULE



1.CONFIGURE YOUR MODULE



7W / 10W

15W

Family	IP	Power	Color T	Beam Angle	Finish	Control System	
0703 Elios Bell Module	2 IP20	7 7W	927 2700K CRI90	1 15°	1 White	W CASAMBI	
		1 10W	930 3000K CRI90	2 24°	2 Black	D BALI	
		5 15W	940 4000K CRI90	3 36°		C TRIAC	
	5 IP54	5 15W	5 15W	940 4000K CRI90	5 50°		ON/OFF
			7 7W	TW 2400-6500K THRIVE			W CASAMBI
							D BALI

0703

2

7

927

1

1

W

07032792711W — Elios Bell Module IP20 7W 2700K CRI90 15° White Casambi

2.CHOOSE YOUR TRIM



Trim White
0700PP0303



Trim Black
0700PP0304



Trimless
0700PP0301



Double White
0700PP0305



Double Black
0700PP0306



Double Trimless White
0700PP0307



Double Trimless Black
0700PP0308

3.FINAL CONFIGURATIONS OF MODULES AND TRIMS

Examples of combinations module + trim

Individual Module

1.Choose your Module

2.Choose your Trim

3.Your Final Product



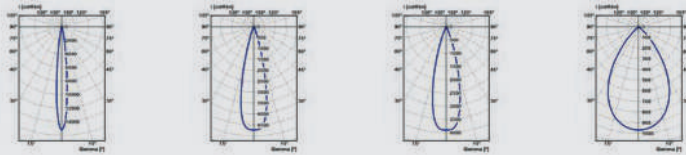
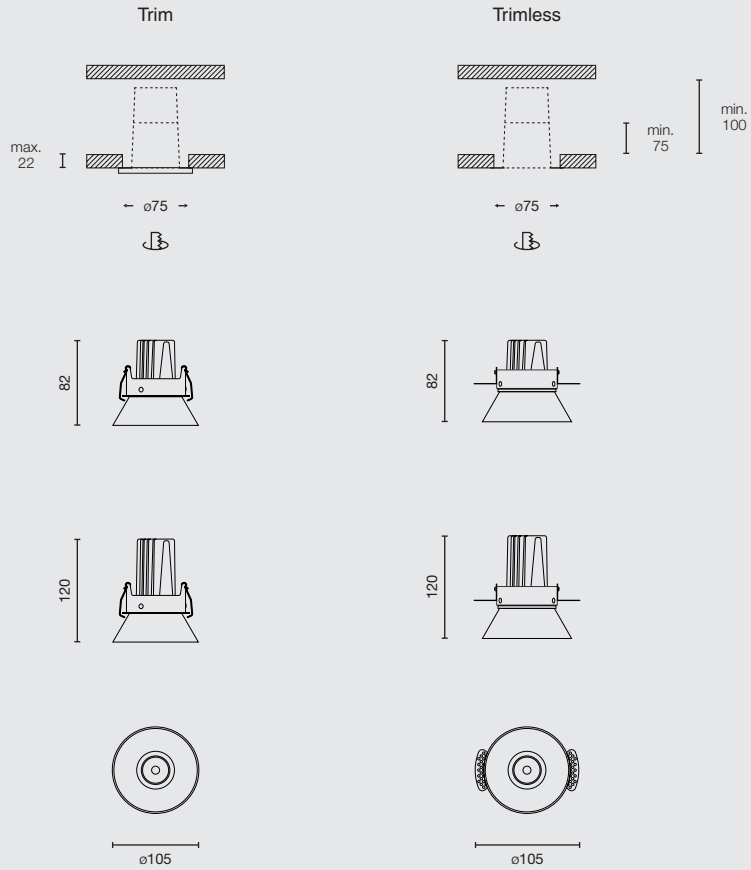

15°

24°

36°

50°

Option	Color T	CRI	Power	Lumen Output	Beam Angle
927	2700K	90	7W	296 / 425 / 469 / 448	15° / 24° / 36° / 50°
			10W	455 / 654 / 722 / 689	15° / 24° / 36° / 50°
			15W	565 / 811 / 895 / 855	15° / 24° / 36° / 50°
930	3000K	90	7W	305 / 438 / 483 / 462	15° / 24° / 36° / 50°
			10W	469 / 674 / 745 / 710	15° / 24° / 36° / 50°
			15W	582 / 836 / 923 / 882	15° / 24° / 36° / 50°
940	4000K	90	7W	314 / 451 / 497 / 475	15° / 24° / 36° / 50°
			10W	483 / 694 / 767 / 731	15° / 24° / 36° / 50°
			15W	599 / 861 / 951 / 908	15° / 24° / 36° / 50°
TW	2700K-6500K	THRIVE	7W	606lm / 628lm / 675lm / 659lm	15° / 24° / 36° / 50°

ELIOS WALL WASHER MODULE



1.CONFIGURE YOUR MODULE



7W / 10W

15W

Family	IP	Power	Color T	Beam Angle	Finish	Control System	
0704 Elios Wall Washer Module	2 IP20	7 7W	927 2700K CRI90	1 15°	1 White	W CASAMBI	
		1 10W	930 3000K CRI90	2 24°	2 Black	D DALI	
		5 15W	940 4000K CRI90	3 36°		C TRIAC	
				5 50°			ON/OFF
		5 IP54	7 7W	TW 2400-6500K THRIVE			W CASAMBI
							D DALI

0704 2 7 927 1 1 W

07042792711W — Elios Wall Washer Module IP20 7W 2700K CRI90 15° White Casambi

2.CHOOSE YOUR TRIM

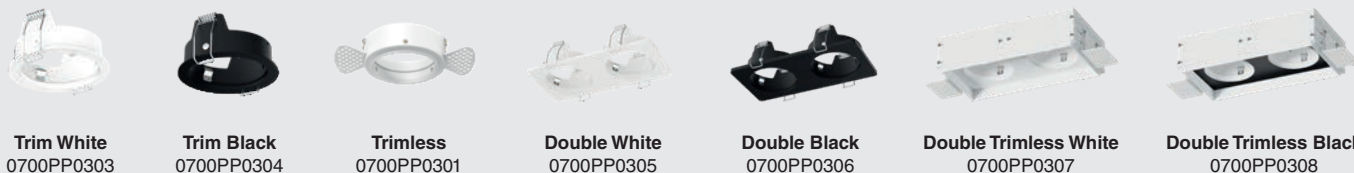

3.FINAL CONFIGURATIONS OF MODULES AND TRIMS

Examples of combinations module + trim

Individual Module

1.Choose your Module 2.Choose your Trim 3.Your Final Product



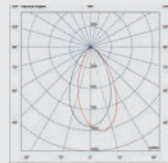
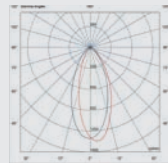
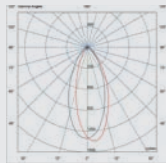
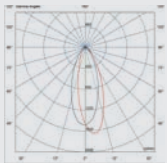
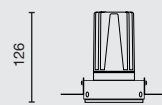
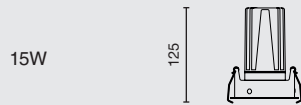
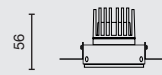
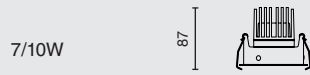
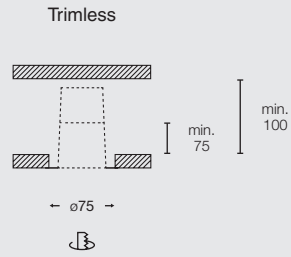
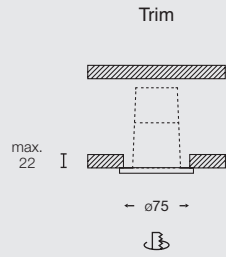

15°

24°

36°

50°

Option	Color T	CRI	Power	Lumen Output	Beam Angle
927	2700K	90	7W	139 / 178 / 199 / 182	15° / 24° / 36° / 50°
			10W	214 / 274 / 306 / 280	15° / 24° / 36° / 50°
			15W	265 / 340 / 380 / 347	15° / 24° / 36° / 50°
930	3000K	90	7W	143 / 184 / 205 / 188	15° / 24° / 36° / 50°
			10W	221 / 282 / 315 / 289	15° / 24° / 36° / 50°
			15W	273 / 351 / 392 / 358	15° / 24° / 36° / 50°
940	4000K	90	7W	147 / 190 / 211 / 194	15° / 24° / 36° / 50°
			10W	228 / 291 / 324 / 298	15° / 24° / 36° / 50°
			15W	281 / 362 / 404 / 369	15° / 24° / 36° / 50°
TW	2700K-6500K	THRIVE	7W	332lm / 346lm / 357lm / 335lm	15° / 24° / 36° / 50°



1.CONFIGURE YOUR MODULE



10W

Family	Color T	Beam Angle	Finish	Control System
0705 Elios Art	1 10W 927 2700K CRI90 930 3000K CRI90 940 4000K CRI90	7 Framers Spot	2 Black	W CASAMBI D DALI ON/OFF

0705 1 927 7 2 W

07052792711W — Elios Art Module IP20 10W 2700K CRI90 Framers Spot Black Casambi

2.CHOOSE YOUR TRIM



Trim White
0700PP0303



Trim Black
0700PP0304



Trimless
0700PP0301



Double White
0700PP0305



Double Black
0700PP0306



Double Trimless White
0700PP0307



Double Trimless Black
0700PP0308

3.FINAL CONFIGURATIONS OF MODULES AND TRIMS

Examples of combinations module + trim

Individual Module

1.Choose your Module

2.Choose your Trim

3.Your Final Product



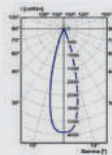
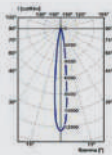
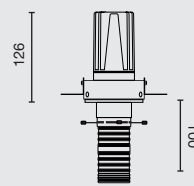
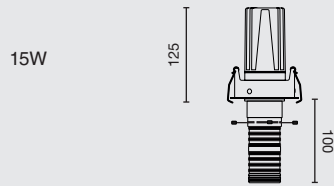
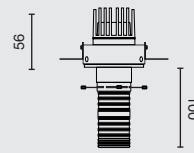
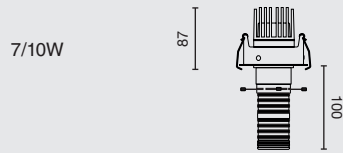
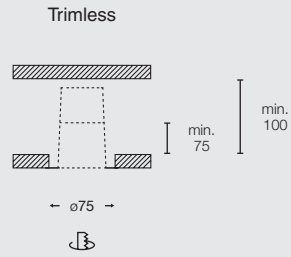
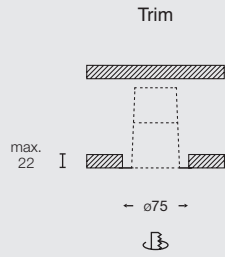

18°

36°

Option	Color T	CRI	Power	Lumen Output	Beam Angle
927	2700K	90	10W	139 / 178 / 199 / 182	18° to 36°
				214 / 274 / 306 / 280	18° to 36°
				265 / 340 / 380 / 347	18° to 36°
930	3000K	90	10W	143 / 184 / 205 / 188	18° to 36°
				221 / 282 / 315 / 289	18° to 36°
				273 / 351 / 392 / 358	18° to 36°
940	4000K	90	10W	147 / 190 / 211 / 194	18° to 36°
				228 / 291 / 324 / 298	18° to 36°
				281 / 362 / 404 / 369	18° to 36°



ALIA

The ALIA downlight stands out for its compact design, making it ideal for installations that require a low recess depth. Its innovative hinge allows for a 90-degree pivot, making it the perfect choice for illuminating artwork or other focal points in a space. ALIA is a product with a very specific function, designed to provide precise and efficient solutions in projects that demand focused and versatile lighting.

El downlight ALIA se distingue por su diseño compacto, ideal para instalaciones que requieren una baja cota de empotramiento. Su innovadora bisagra permite un giro de 90 grados, lo que lo convierte en la opción perfecta para iluminar cuadros u otros elementos destacados en el espacio. ALIA es un producto con una función muy específica, diseñado para ofrecer soluciones precisas y eficientes en proyectos que demandan una iluminación dirigida y versátil.



MODULE

Modulo

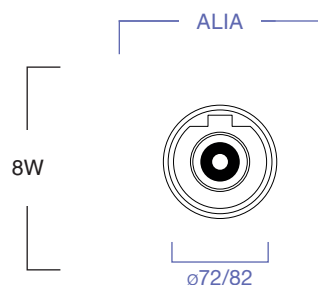

FINISH

Acabado

● **Black**
Negro

○ **White**
Blanco

COLOR TEMPERATURE

Temperatura de color

2700K CRI90

3000K CRI90

BEAM ANGLE

Ángulo de apertura

15°

24°

36°

50°

CONTROL SYSTEM

Sistema de control



CASAMBI



Highlights

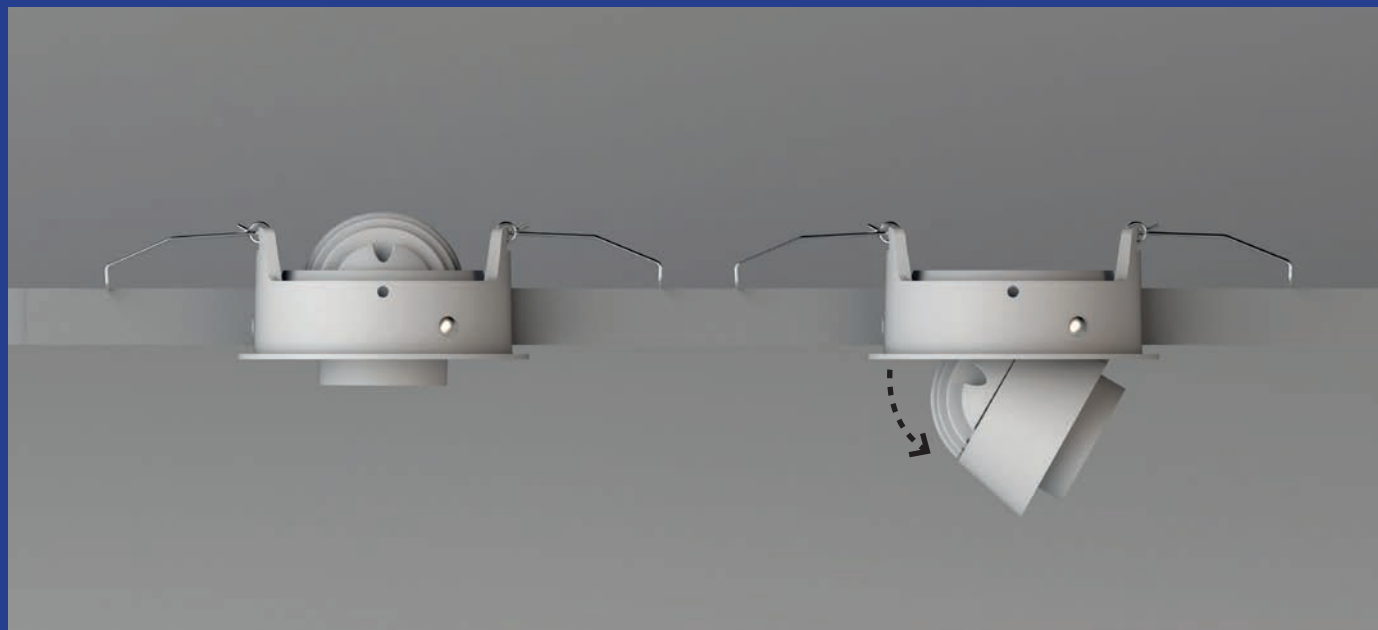

Low ceiling height

Altura de techo baja

This luminaire is designed for low ceiling applications, offering flexibility with various color temperature options to adapt to different settings. It ensures high efficiency, promoting energy savings and sustainability. Additionally, it features connectivity capabilities, allowing integration with modern control systems for enhanced functionality.

Esta luminaria está diseñada para aplicaciones con techos bajos, ofreciendo flexibilidad con varias opciones de temperatura de color para adaptarse a diferentes entornos. Garantiza una alta eficiencia, promoviendo el ahorro de energía y la sostenibilidad. Además, cuenta con capacidades de conectividad, permitiendo la integración con sistemas de control modernos para una funcionalidad mejorada.



Several color temperatures
Varias temperaturas de color



High Efficiency
Alta eficacia



Connectivity
Conectividad



Residential



Office

Beam Angle

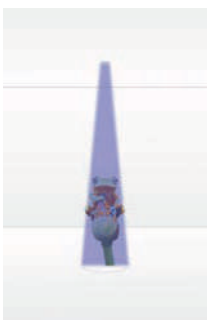

15°

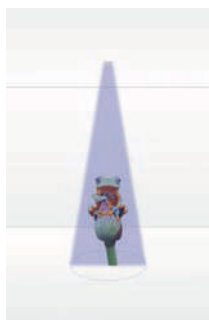

24°

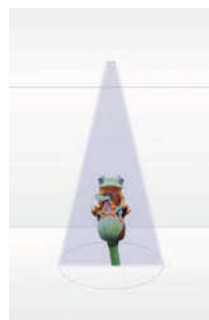

36°

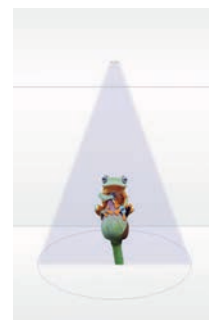

50°

ALIA 8W

incl. DIM 90° 50.000hs L90 / B10 MacAdam 3 220-240V 650°C

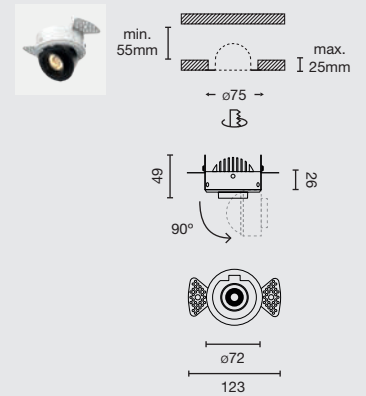
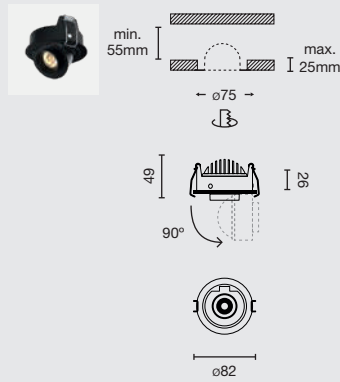

Family	Color T	Beam Angle	Finish	Control System
0800 Alia 8W	927 2700K CRI90	1 15°	1 White	W CASAMBI
0801 Alia Trimless 8W	930 3000K CRI90	2 24°	2 Black	D DALI
		3 36°		C TRIAC
		5 50°		ON/OFF

0800 **927** **1** **1** **W**

Example **080092711W** — Alia Downlight 8W 2700K CRI90 15° White Casambi

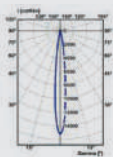

15°

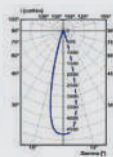

24°

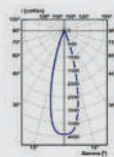

36°

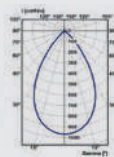

50°

Option	Color T	CRI	Power	Lumen Output	Beam Angle
927	2700K	90	8W	687lm / 717lm / 1000lm / 831lm	15° / 24° / 36° / 50°
930	3000K	90	8W	708lm / 738lm / 1030lm / 856lm	15° / 24° / 36° / 50°
940	4000K	90	8W	731lm / 760lm / 1062lm / 884lm	15° / 24° / 36° / 50°



IZAR

The IZAR model is characterized by its adjustable tilt angle, which allows for precise light direction to highlight specific elements. This accent lighting design is perfect for projects that require exact control of the light focus. With a modern and functional style, IZAR is the ideal solution for those looking to emphasize architectural or decorative details with efficient and flexible lighting.

El modelo IZAR se caracteriza por su capacidad de ajuste en el ángulo de inclinación, lo que permite dirigir la luz con precisión para resaltar elementos específicos. Este diseño de iluminación de acento es perfecto para proyectos que requieren un control exacto del enfoque lumínico. Con un estilo moderno y funcional, IZAR se convierte en una solución ideal para quienes buscan destacar detalles arquitectónicos o decorativos con una iluminación eficiente y flexible.

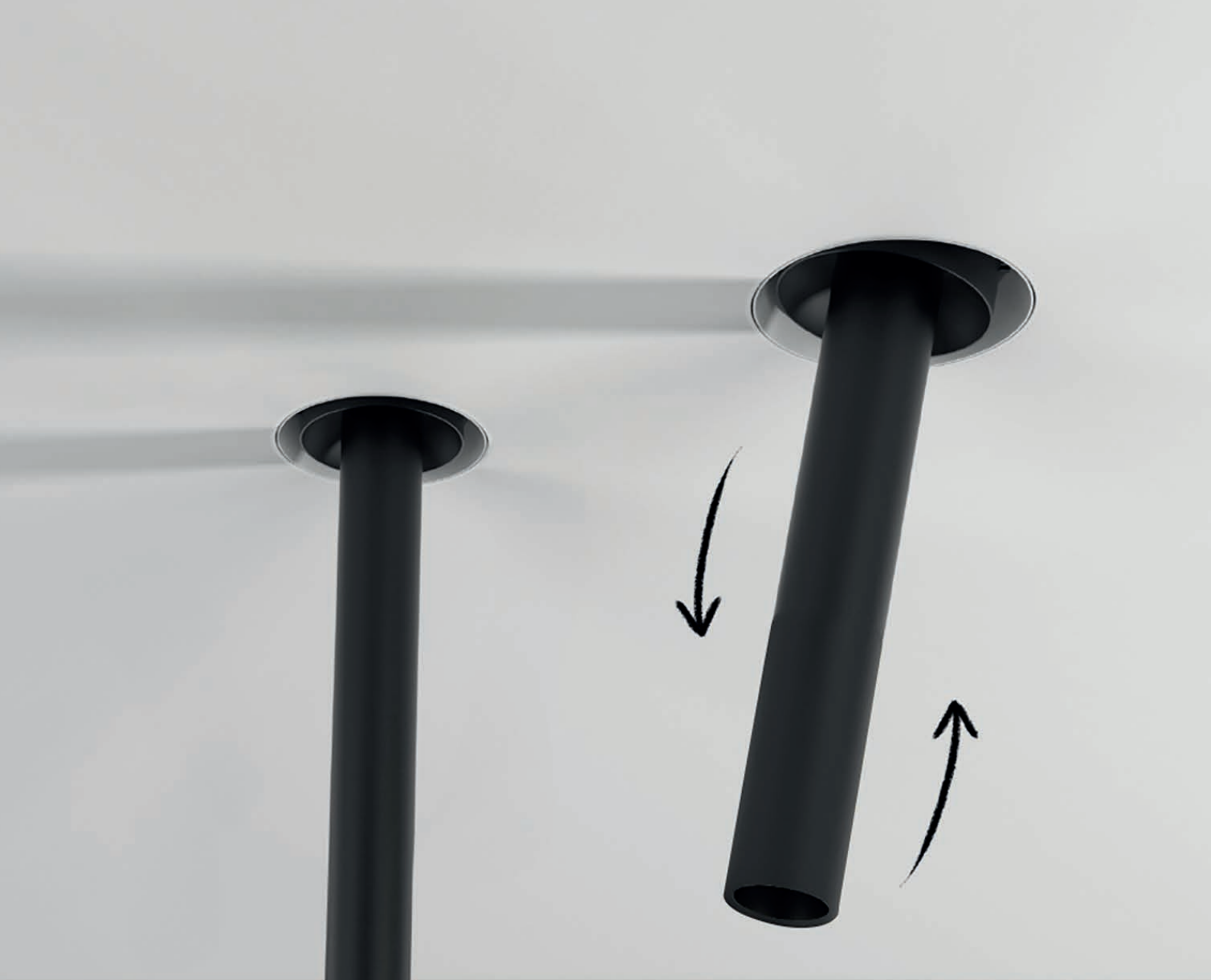

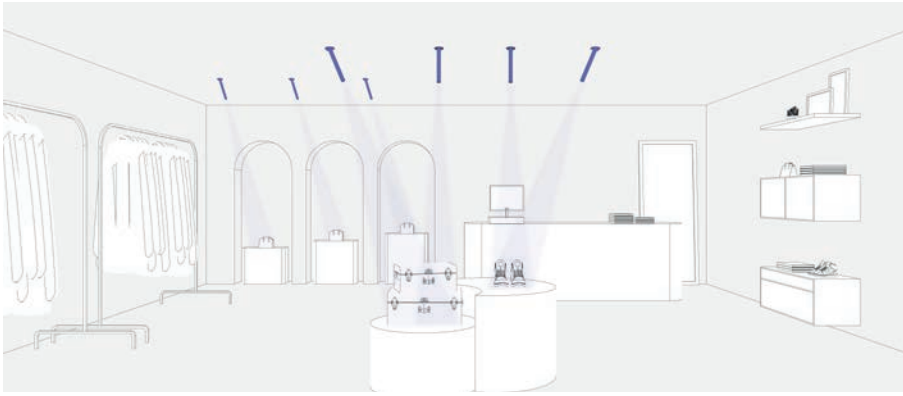

Retail



Residential

Beam Angle

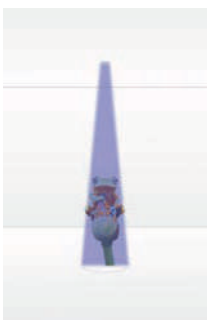

15°

MODULE

Modulo

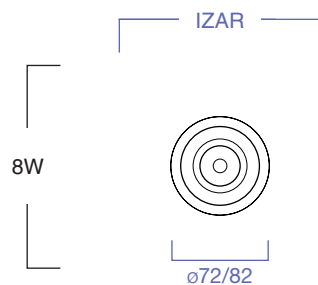

FINISH

Acabado

● **Black**
Negro

○ **White**
Blanco

COLOR TEMPERATURE

Temperatura de color

2700K CRI90

3000K CRI90

BEAM ANGLE

Ángulo de apertura

15°

CONTROL SYSTEM

Sistema de control



CASAMBI



Highlights

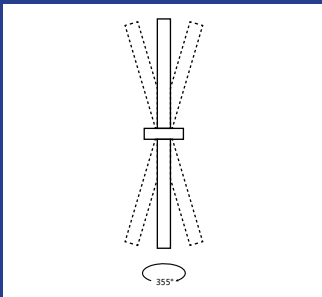

Diferent heights and angles
Diferentes alturas y ángulos

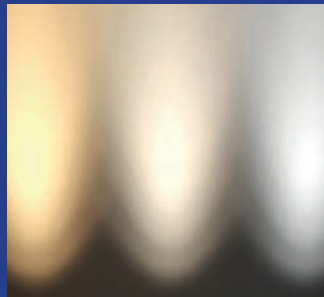

Several color temperatures
Varias temperaturas de color



Connectivity
Conectividad

IZAR DOWNLIGHT

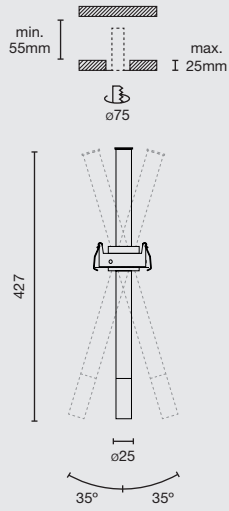

- incl.
- DIM
- 355°
- 35°
- 50.000hs
L80 / B10
- MacAdam 3
- 220-240V
- 650°C

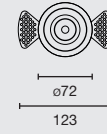

Family	Color T	Beam Angle	Finish	Control System
0900 Izar 8W	927 2700K CRI90	1 15°	1 White	W CASAMBI
0901 Izar Trimless 8W	930 3000K CRI90		2 Black	D BALI
				C TRIAC
				ON/OFF

0900 927 1 1 W
 Example **090092711W** — Alia Downlight 8W 2700K CRI90 15° White Casambi

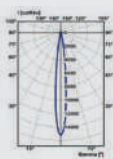

15°

Option	Color T	CRI	Power	Lumen Output	Beam Angle
927	2700K	90	8W	288lm	15°
930	3000K	90	8W	235lm	15°
940	4000K	90	8W	243lm	15°

TULIPA is the ideal solution when light quality and great visual comfort are needed. Downlight with aluminium injection frame and high-quality finishes which, thanks to its cut-off and its integrated honeycomb, guarantees maximum visual comfort.

TULIPA es la solución ideal cuando se precisa calidad de luz y gran confort visual. Downlight con marco de inyección de aluminio y acabados de alta calidad que, gracias a su cut-off y su panel de abeja integrado, garantiza el máximo confort visual.



TULIPA





MODULE
Modulo

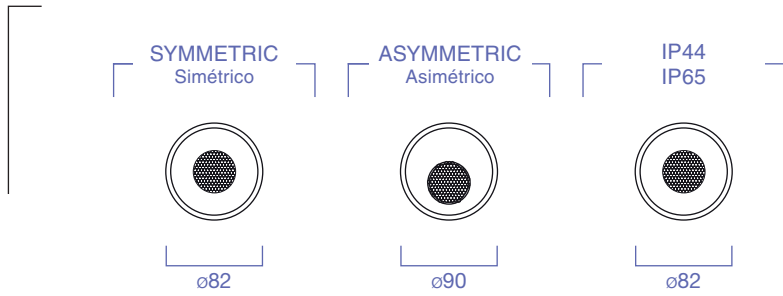

N 7W/10W/15W



FINISH
Acabado

● **Black**
Negro

○ **White**
Blanco

COLOR TEMPERATURE
Temperatura de color

2700K CRI90

3000K CRI90

4000K CRI90

BEAM ANGLE
Ángulo de apertura

15°

24°

36°

50°

ACCESSORIES
Accesorios



Supplementary
White Ring



Supplementary
Black Ring

CONTROL SYSTEM
Sistema de control



CASAMBI



Highlights

Optical block formed by a secondary aluminium injection reflector which at the same time functions as a recess ring, integrated honeycomb, along with a high-purity PMMA lens.

Bloque óptico formado por un reflector secundario de inyección de aluminio que a la vez ejerce de aro de empotramiento, panel de abeja integrado junto con una lente de PMMA de alta pureza.



Built-in Honeycomb
Panel de abeja incorporado



Symmetric / Asymmetric / Adjustable
Simétrico / Asimétrico / Orientable



Simple Clipping System
Sistema de clipaje simple



Optional IP65
Opción IP65



High CRI
Alto IRC



Several Color Temperatures
Varias temperaturas de color

Accessories

**Supplementary
White Ring**

033500098

**Supplementary
Black Ring**

033500099



**Supplementary
White Ring ø96**
ø96 Anillo suplementario blanco



**Supplementary
Black Ring ø96**
ø96 Anillo suplementario negro





Residential



Office



Restaurant

Beam Angle

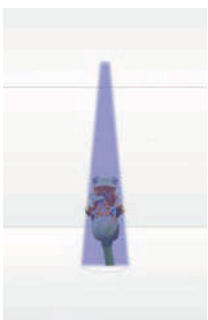

15°



24°

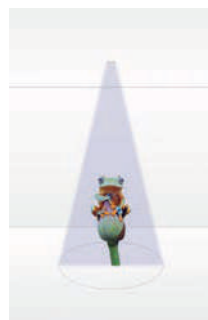

36°

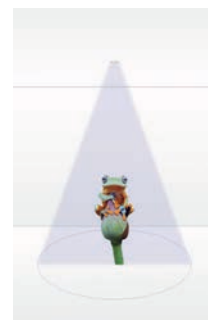

50°

TULIPA SYMMETRIC

incl. DIM 50.000hs L70 / B10 MacAdam 3 220-240V 650°C UGR <16

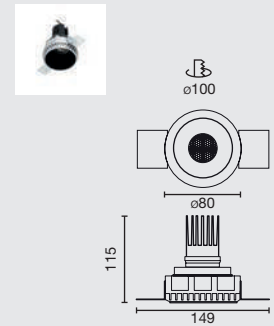
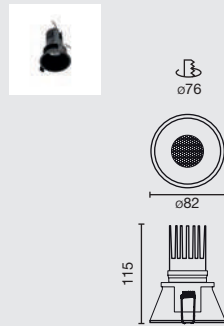

Family	Power	Color T	Beam Angle	Finish	Control System
0335 Tulipa	1 7W	927 2700K CRI90	1 15°	1 White	W CASAMBI
0334 Tulipa IP65	2 10W	930 3000K CRI90	2 24°	2 Black	D DALI
0338 Tulipa Trimless	5 15W N	940 4000K CRI90	3 36°		C TRIAC
			5 50°		ON/OFF

0335 1 927 1 1 W

Example **0335192711W** — Tulipa trim 7W 2700K CRI95 15° White Casambi

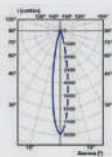

15°

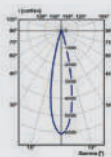

24°



36°



50°

Option	Color T	CRI	Power	Lumen Output	Beam Angle
927	2700K	90	7W	396 / 492 / 540 / 495	15° / 24° / 36° / 50°
			10W	608 / 757 / 831 / 761	15° / 24° / 36° / 50°
			15W	755 / 939 / 1031 / 944	15° / 24° / 36° / 50°
930	3000K	90	7W	408 / 507 / 557 / 510	15° / 24° / 36° / 50°
			10W	627 / 780 / 857 / 785	15° / 24° / 36° / 50°
			15W	778 / 967 / 1063 / 973	15° / 24° / 36° / 50°
940	4000K	90	7W	420 / 522 / 573 / 525	15° / 24° / 36° / 50°
			10W	646 / 803 / 883 / 809	15° / 24° / 36° / 50°
			15W	801 / 996 / 1095 / 1002	15° / 24° / 36° / 50°

TULIPA ASYMMETRIC

incl. DIM 50.000hs L70 / B10 MacAdam 3 220-240V 650°C UGR <16

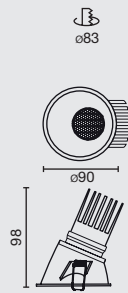

Family	Power	Color T	Beam Angle	Finish	Control System	
0336 Tulipa Asy.	1 7W	927 2700K CRI90	1 15°	1 White	W CASAMBI D DALI C TRIAC ON/OFF	
		930 3000K CRI90				2 24°
		940 4000K CRI90				3 36°
	2 10W		4 50°	2 Black		
	5 15W N					

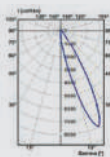

*15°

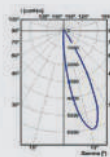

*24°

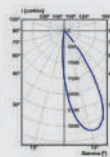

*36°

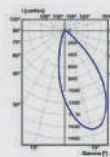

*50°

Option	Color T	CRI	Power	Lumen Output	Beam Angle
927	2700K	90	7W	439 / 497 / 545 / 507	15° / 24° / 36° / 50°
			10W	674 / 764 / 839 / 781	15° / 24° / 36° / 50°
			15W	836 / 948 / 1040 / 968	15° / 24° / 36° / 50°
930	3000K	90	7W	452 / 512 / 562 / 523	15° / 24° / 36° / 50°
			10W	695 / 788 / 865 / 805	15° / 24° / 36° / 50°
			15W	862 / 977 / 1072 / 998	15° / 24° / 36° / 50°
940	4000K	90	7W	466 / 527 / 579 / 539	15° / 24° / 36° / 50°
			10W	716 / 812 / 891 / 829	15° / 24° / 36° / 50°
			15W	888 / 1006 / 1104 / 1028	15° / 24° / 36° / 50°

*Beam angle with 30° inclination
*Ángulo con 30° inclinación

TULIPA ADJUSTABLE

incl. DIM 25° 50.000hs L70 / B10 MacAdam 3 220-240V 650°C UGR <16

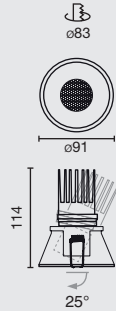

Family	Power	Color T	Beam Angle	Finish	Control System
0339 Tulipa adjustable	1 7W	927 2700K CRI90	1 15°	1 White	W CASAMBI
	2 10W	930 3000K CRI90	2 24°	2 Black	D DALI
	5 15W N	940 4000K CRI90	3 36°		C TRIAC
			5 50°		ON/OFF

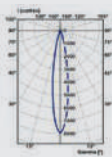

15°

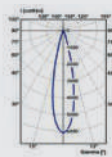

24°

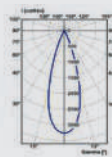

36°

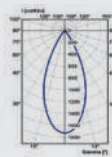

50°

Option	Color T	CRI	Power	Lumen Output	Beam Angle
927	2700K	90	7W	469 / 508 / 570 / 474	15° / 24° / 36° / 50°
			10W	721 / 782 / 876 / 730	15° / 24° / 36° / 50°
			15W	893 / 970 / 1086 / 905	15° / 24° / 36° / 50°
930	3000K	90	7W	483 / 524 / 587 / 489	15° / 24° / 36° / 50°
			10W	743 / 806 / 903 / 752	15° / 24° / 36° / 50°
			15W	921 / 1000 / 1120 / 933	15° / 24° / 36° / 50°
940	4000K	90	7W	498 / 540 / 605 / 504	15° / 24° / 36° / 50°
			10W	765 / 830 / 930 / 775	15° / 24° / 36° / 50°
			15W	949 / 1030 / 1154 / 961	15° / 24° / 36° / 50°





UNO



Size does matter. UNO has a design that is small in dimension and a large capacity to create environments with light with minimum visual invasion, both in the space and on the recess surface.



El tamaño sí importa. UNO presenta un diseño de reducidas dimensiones y una gran capacidad de crear entornos con luz con la mínima invasión visual, tanto en el espacio como en la superficie de empotramiento.



MODULE
Modulo



FINISH
Acabado

-  **Black+Black**
Negro+Negro
-  **Black+White**
Negro+Blanco
-  **White+White**
Blanco+Blanco
-  **White+Black**
Blanco+Negro
-  **Black+Gold**
Negro+Oro
-  **White+Gold**
Blanco+Oro

COLOR TEMPERATURE
Temperatura de color

2700K CRI90

3000K CRI90

BEAM ANGLE
Ángulo de apertura

11°

24°

37°

ACCESSORIES
Accesorios



Honeycomb

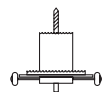

Trimless Tool

CONTROL SYSTEM
Sistema de control



Highlights



The size/flow ratio of its downlight and extractable projector versions makes it possible to fulfill the requirements needed for applications in hotels, restaurants and retail, as well as its domestic application.

La relación tamaño-flujo de sus versiones downlight y proyector extraíble hacen posible que, además de su aplicación doméstica, cumpla con las exigencias requeridas para aplicaciones en hoteles, restaurantes y retail.

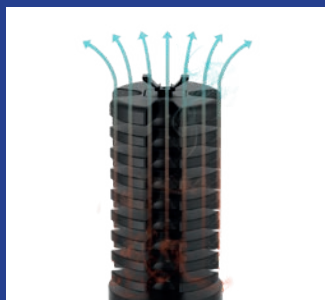

Passive heat dissipation system
Sistema de disipación térmica pasiva



Glare control
Control de deslumbramiento

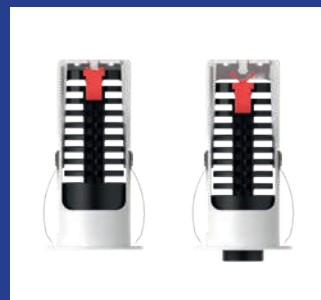

Removable downlight module
Módulo downlight extraíble a presión



High Efficiency CRI90
Alta eficiencia



Several color temperatures
Varias temperaturas de color





Honeycomb
Panal de abeja



Trimless Tool
Herramienta sin marco

Accessories

Honeycomb

035300099

Uno Trimless Tool

35300098

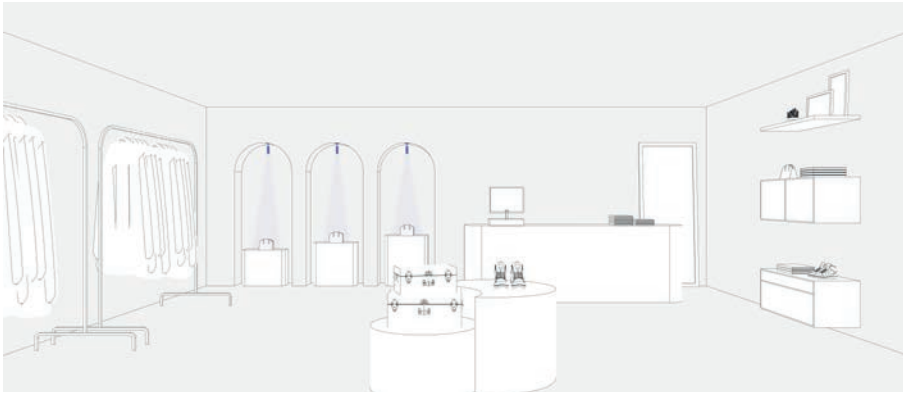

Retail



Restaurant



Residential

Beam Angle

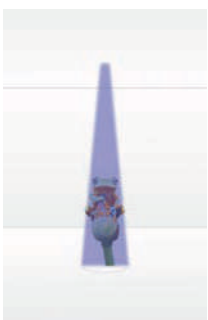

11°

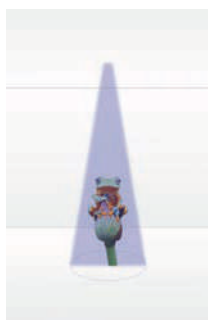

24°

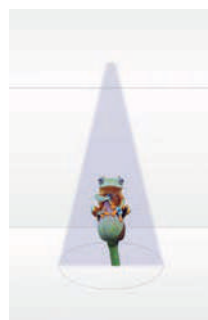

37°

UNO DOWNLIGHT 8W

incl. DIM 50.000hs L80 / B10 MacAdam 3 220-240V 50 / 60Hz 650°C



Family	Color T	Beam Angle	Finish	Ring	Control System
0331 Uno Trim 8W	927 2700K CRI90	1 11°	1 White	1 White	D DALI
0332 Uno Trimless 8W	930 3000K CRI90	2 24°	2 Black	2 Black	ON/OFF
		3 37°		4 Gold	

0331 **927** **1** **1** **1** **D**

Example **0331927111W** — Uno trim 8W 2700K CRI90 11° White, White Ring Dali

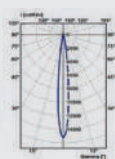

11°

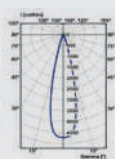

24°

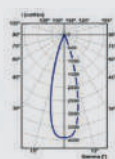

37°

Option	Color T	CRI	Power	Lumen Output	Beam Angle
927	2700K	90	8W	347lm / 346lm / 331lm	11° / 24° / 37°
930	3000K	90	8W	358lm / 357lm / 341lm	11° / 24° / 37°

UNO PULLDOWN PROJECTOR 8W

incl. DIM 355° 90° 50.000hs L80 / B10 MacAdam 3 220-240V 50 / 60Hz 650°C

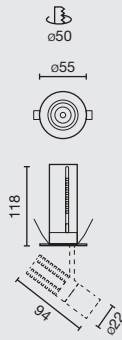
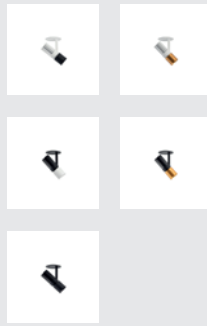

Family	Color T	Beam Angle	Finish	Ring	Control System
0333 Uno Pulldown 8W	927 2700K CRI90	1 11°	1 White	1 White	D ON/OFF
	930 3000K CRI90	2 24°	2 Black	2 Black	
		3 37°		4 Gold	

0331 927 1 1 1 D

Example **0331927111W** — Uno trim 8W 2700K CRI90 11° White, White Ring Dali

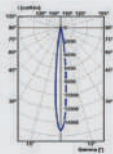

11°

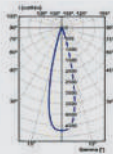

24°

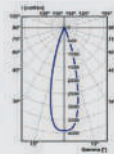

37°

Option	Color T	CRI	Power	Lumen Output	Beam Angle
927	2700K	90	8W	736lm / 736lm / 704lm	11° / 24° / 37°
930	3000K	90	8W	759lm / 759lm / 725lm	11° / 24° / 37°

The KOPE downlight is the perfect solution for spaces with sloped ceilings or where precise light orientation is required. This versatile and compact downlight can be tilted and recessed according to lighting needs, providing complete control over the direction of light and adding functionality and elegance to any space.

El downlight KOPE es la solución perfecta para espacios con techos inclinados o donde se requiere una orientación precisa de la luz. Este downlight versátil y de dimensiones reducidas se puede inclinar y retraer según las necesidades de iluminación, brindando un control total sobre la dirección de la luz y dotando de funcionalidad y elegancia cualquier tipo de espacio.





KOPE

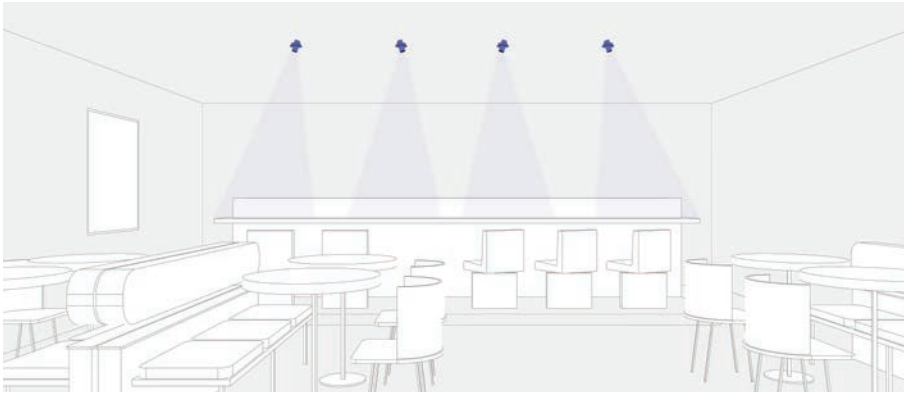

Restaurant



Home

Beam Angle



20°

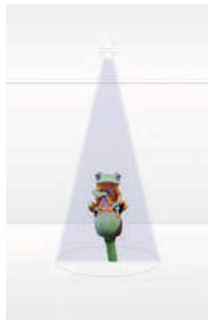

36°

MODULE
Modulo

Kope 7W

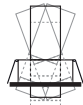

ø85

Kope 13W

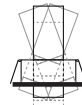

ø100

FINISH
Acabado

● **Black**
Negro

○ **White**
Blanco

COLOR TEMPERATURE
Temperatura de color

2700K CRI90

3000K CRI90

4000K CRI90

BEAM ANGLE
Ángulo de apertura

20°

36°

CONTROL SYSTEM
Sistema de control



CASAMBI

Highlights

With two sizes and powers, Kope stands out for its ability to be adjustable, as well as for its “up-down” movement. Ideal for sloped ceilings where the light beam is to be kept vertical, or for light points where an adjustable or directional beam is desired.

Con dos tamaños y potencias, Kope destaca por la posibilidad de ser orientable, así como del movimiento “up down”. Ideal para techos inclinados en los que lo que se quiera mantener el haz de luz en vertical, o para puntos de luz donde se busque un haz inclinable u orientable.



Consider the Installation Height in your Project

Tenga en cuenta la altura de la instalación en su proyecto



High CRI Alto IRC

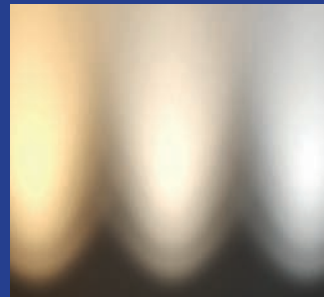

Several Color Temperatures Varias temperaturas de color



Adjustable with Up & Down Ajustable hacia arriba y hacia abajo

KOPE

incl. DIM 50.000hs L90 / B10 MacAdam 3 220- 50/ 240V 60Hz 650°C

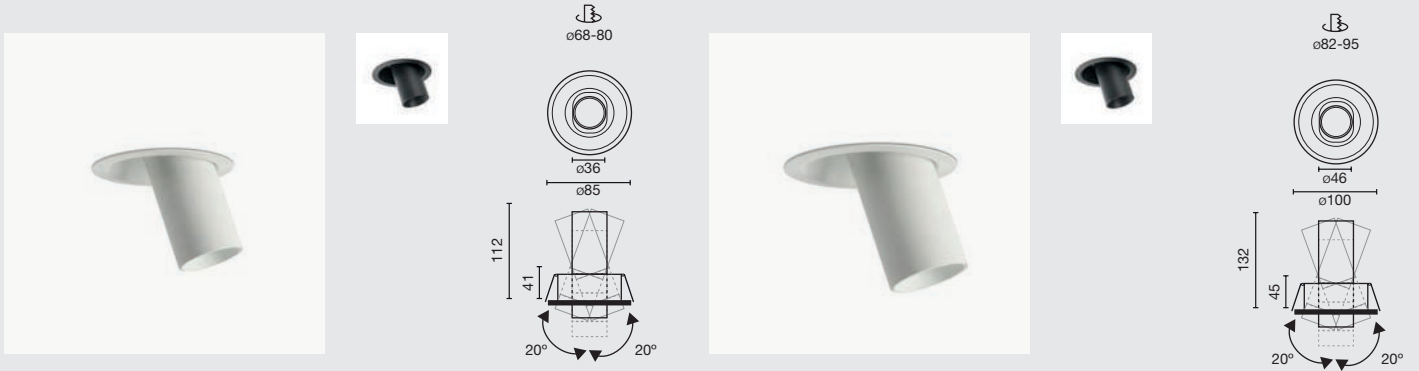

Family	Color T	Beam Angle	Finish	Control System
0225 Kope 7W	927 2700K CRI90	2 20°	1 White	W CASAMBI
0226 Kope 13W	930 3000K CRI90	4 36°	2 Black	D DALI
	940 4000K CRI90			ON/OFF

0354 927 6 1 W

Example 0022592721W — Kope 7W 2700K CRI90 20° White Casambi

Kope 7W

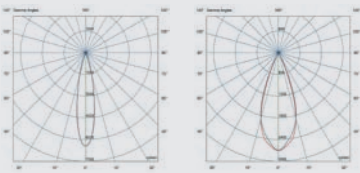

20°

36°

Kope 13W

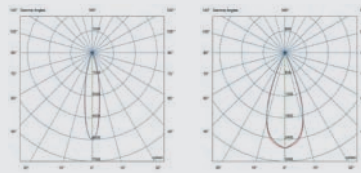

20°

36°

Option	Color T	CRI	Power	Lumen Output	Beam Angle
927	2700K	90	7w	451/494	20°/36°
		90	13w	859/818	20°/36°
930	3000K	90	7w	465/495	20°/36°
		90	13w	886/837	20°/36°
940	4000K	90	7w	479/524	20°/36°
		90	13w	913/868	20°/36°

DEEP is a series of recessed light fixtures available in 3 sizes (S, M, L), two formats (round or square) and with trim or trimless. Its wide range of color temperatures, different optics and CRI options makes it a perfect option for commercial spaces, hotels, restaurants and retail. Its accessories enable better glare control and maximum visual comfort.

DEEP es una serie de luminarias empotradas disponible en 3 tamaños (S, M, L), dos formatos (redondo o cuadrado) y opción con marco y sin marco. Su amplia gama de temperatura de color, diversas ópticas y opciones de IRC la convierten en una opción perfecta para espacios comerciales, hoteles, restauración y retail. Sus accesorios permiten un mejor control del deslumbramiento, así como maximizar el confort visual.

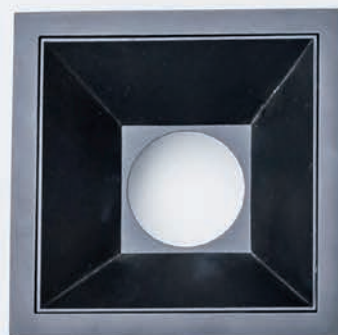



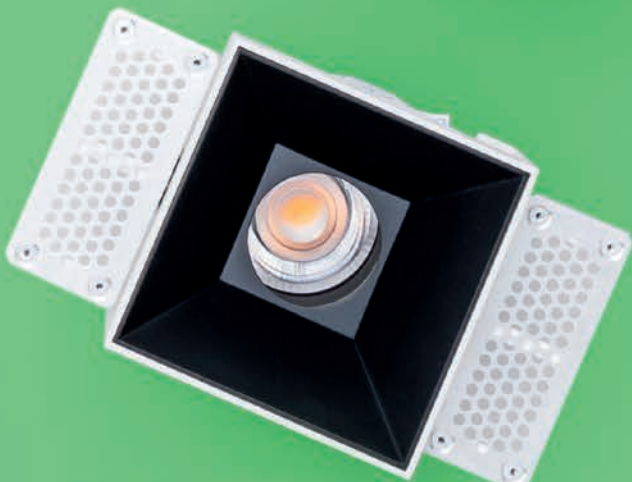
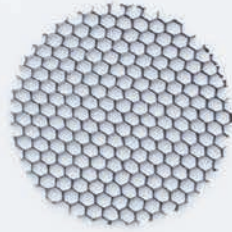

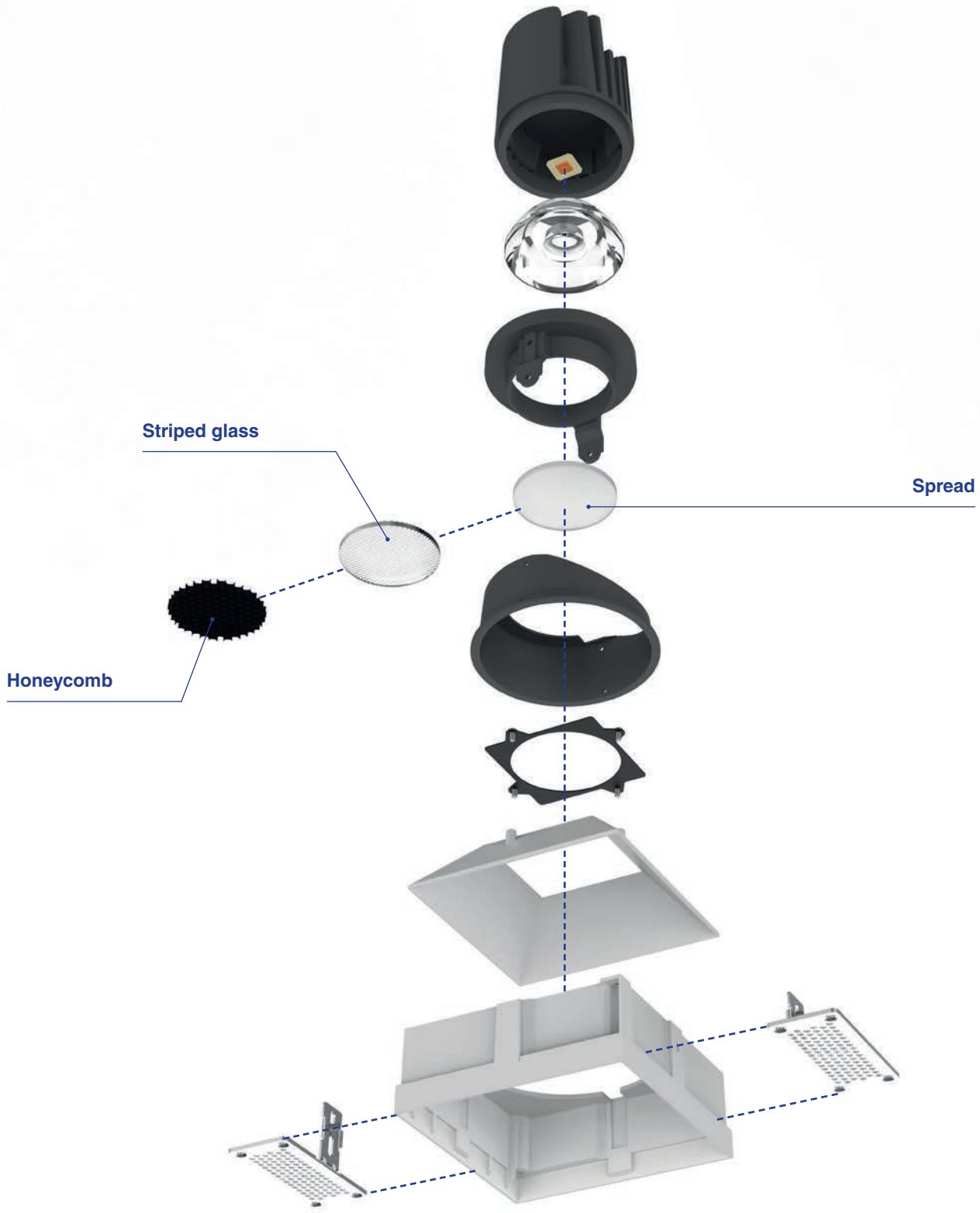



DEEP



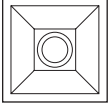
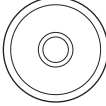
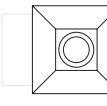
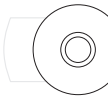

MODULE
Modulo

	TRIM Con marco		TRIMLESS Sin marco	
S 6 / 11W	 95x95	 ø93	 85x85	 ø83
M 12 / 18W	 115x115	 ø115	 103x103	 ø103
L 18 / 25 / 39W	 135x135	 ø135	 123x123	 ø123

FINISH
Acabado

- Black**
Negro
- White**
Blanco



COLOR TEMPERATURE
Temperatura de color

- 2700K CRI90
- 3000K CRI90
- 4000K CRI90
- FASHION

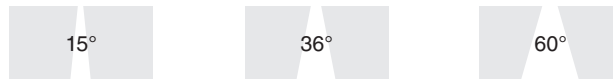
BEAM ANGLE
Ángulo de apertura



ACCESSORIES
Accesorios

- 
Honeycomb
- 
Striped glass
- 
Spread Glass

CONTROL SYSTEM
Sistema de control



Highlights

Fashion LED



With a standard LED, fabrics appear the same, and shades of white are not clearly distinguishable.

Con un LED común las telas parecen iguales, los tonos de blanco no se distinguen claramente.



An LED Fashion identifies the shade of each fabric, showing the nuances of all whites.

Con un LED Fashion se identifica la tonalidad de cada tela, mostrando los matices de todos los blancos.



Different sizes
Diversos tamaños



High-quality materials
Materiales de alta calidad



Adjustable
Orientable

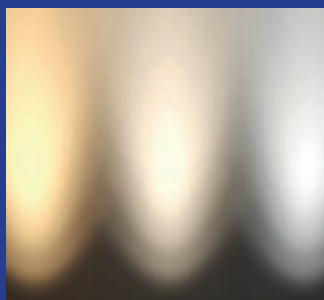

Several color temperatures
Varias temperaturas de color

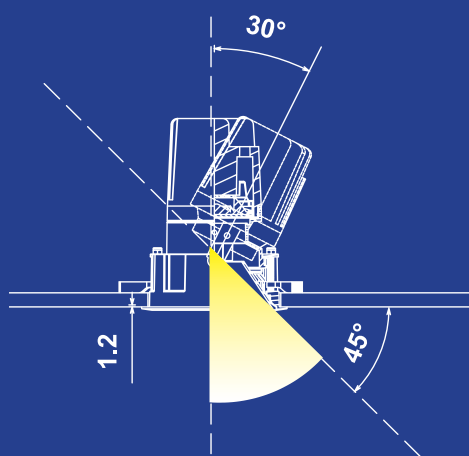



Options



Without Accessory
Sin accesorios



Striped Glass
Vidrio estirado



Spread Glass
Vidrio difusor



Honeycomb
Panel de abeja



Without Accessory



Striped Glass



Spread Glass



Honeycomb



Office



Restaurant

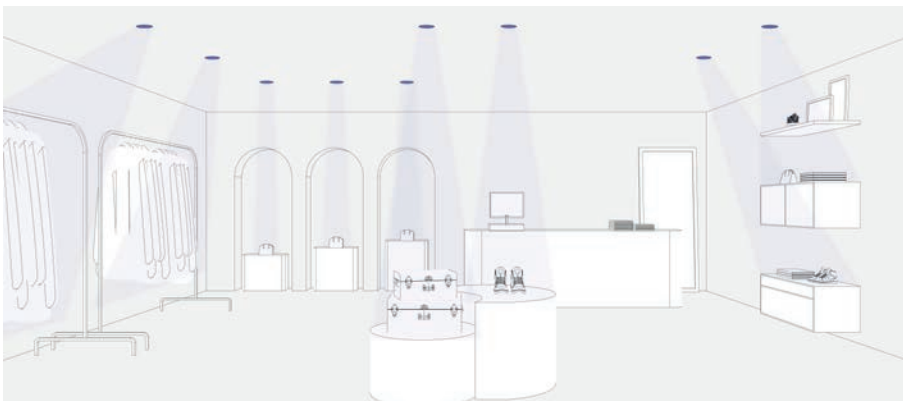

Retail

Beam Angle

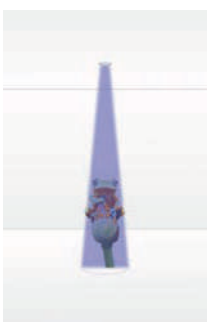

15°



36°

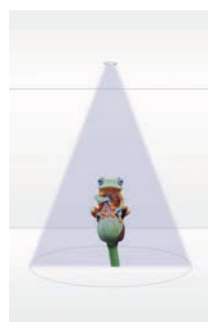

60°

DEEP S Round

no incl. DIM 355° 30° 50.000hs L80 / B10 MacAdam 2 IP23 6W 200mA 29V 11W 350mA 30V 650°C

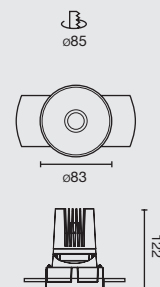
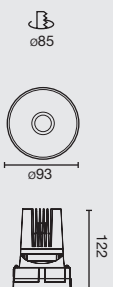

Family

Color T

Beam Angle

Finish

Accessory

30135 Deep S Round	927 2700K CRI90	1 15°	1 White	H Honeycomb
30235 Deep S Round Trimless	930 3000K CRI90	3 36°	2 Black	S Striped Glass
	940 4000K CRI90	6 60°		D Spread Glass
				No accessory

30135

927

1

1

H

Example **3013592711H** — Deep S Round 2700K 15° White Honeycomb

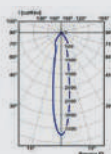

15°



36°



60°

Option	Color T	CRI	Power	Lumen Output	Beam Angle
927	2700K	90	6W	291lm / 352lm / 287lm	15° / 36° / 60°
			11W	466lm / 514lm / 453lm	15° / 36° / 60°
930	3000K	90	6W	301lm / 363lm / 296lm	15° / 36° / 60°
			11W	481lm / 530lm / 467lm	15° / 36° / 60°
940	4000K	90	6W	310lm / 374lm / 305lm	15° / 36° / 60°
			11W	495lm / 546lm / 481lm	15° / 36° / 60°

Driver not included. See recommended drivers on page 506-507.
 Driver no incluido. Ver drivers recomendados en página 506-507.

DEEP S Square

no incl. DIM 355° 30° 50.000hs L80 / B10 MacAdam 2 IP23 6W 200mA 29V 11W 350mA 30V 650°C

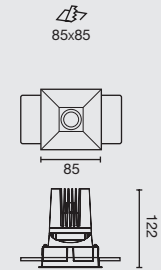
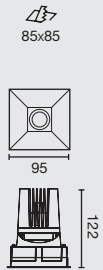

Family	Color T	Beam Angle	Finish	Accessory
30335 Deep S Square	927 2700K CRI90	1 15°	1 White	H Honeycomb
30435 Deep S Square Trimless	930 3000K CRI90	3 36°	2 Black	S Striped Glass
	940 4000K CRI90	6 60°		D Spread Glass
				No accessory

30335 927 1 1 H

Example **3033592711H** — Deep S Square 2700K 15° White Honeycomb

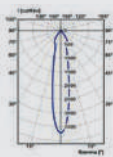

15°

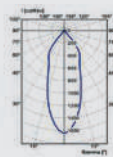

36°

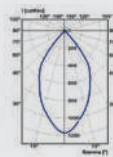

60°

Option	Color T	CRI	Power	Lumen Output	Beam Angle
927	2700K	90	6W	291lm / 352lm / 287lm	15° / 36° / 60°
			11W	466lm / 514lm / 453lm	15° / 36° / 60°
930	3000K	90	6W	301lm / 363lm / 296lm	15° / 36° / 60°
			11W	481lm / 530lm / 467lm	15° / 36° / 60°
940	4000K	90	6W	310lm / 374lm / 305lm	15° / 36° / 60°
			11W	495lm / 546lm / 481lm	15° / 36° / 60°

Driver not included. See recommended drivers on page 506-507.
 Driver no incluido. Ver drivers recomendados en página 506-507.

DEEP M Round

no incl. DIM 355° 30° 50.000hs L80 / B10 MacAdam 2 IP23 12W 350mA 34V 18W 500mA 36V 650°C

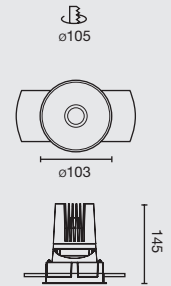

Family	Color T	Beam Angle	Finish	Accessory
30550 Deep M Round	927 2700K CRI90	1 15°	1 White	H Honeycomb
30650 Deep M Round Trimless	930 3000K CRI90	3 36°	2 Black	S Striped Glass
	940 4000K CRI90	6 60°		D Spread Glass
				No accessory

30550 927 1 1 H

Example **3055092711H** — Deep M Round 2700K 15° White Honeycomb

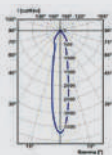

15°



36°

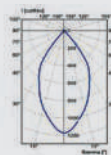

60°

Option	Color T	CRI	Power	Lumen Output	Beam Angle
927	2700K	90	12W	1067lm / 920lm / 764lm	15° / 36° / 50°
			18W	1217lm / 1290lm / 1040lm	15° / 36° / 50°
930	3000K	90	12W	1110lm / 949lm / 788lm	15° / 36° / 50°
			18W	1255lm / 1330lm / 1073lm	15° / 36° / 50°
940	4000K	90	12W	1133lm / 977lm / 811lm	15° / 36° / 50°
			18W	1292lm / 1369lm / 1105lm	15° / 36° / 50°

Driver not included. See recommended drivers on page 506-507.
 Driver no incluido. Ver drivers recomendados en página 506-507.

DEEP M Square

no incl. DIM 355° 30° 50.000hs L80 / B10 MacAdam 2 IP23 12W 350mA 34V 18W 500mA 36V 650°C



105x105



105x105

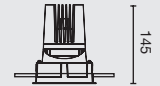
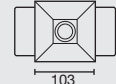

Family	Color T	Beam Angle	Finish	Accessory
30750 Deep M Square	927 2700K CRI90	1 15°	1 White	H Honeycomb
30850 Deep M Square Trimless	930 3000K CRI90	3 36°	2 Black	S Striped Glass
	940 4000K CRI90	6 60°		D Spread Glass
				No accessory

30750 927 1 1 H

Example 3075092711H — Deep M Round 2700K 15° White Honeycomb

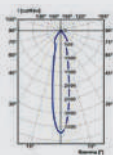

15°

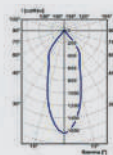

36°

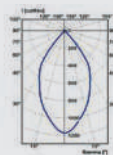

60°

Option	Color T	CRI	Power	Lumen Output	Beam Angle
927	2700K	90	12W	1067lm / 920lm / 764lm	15° / 36° / 50°
			18W	1217lm / 1290lm / 1040lm	15° / 36° / 50°
930	3000K	90	12W	110lm / 949lm / 788lm	15° / 36° / 50°
			18W	1255lm / 1330lm / 1073lm	15° / 36° / 50°
940	4000K	90	12W	1133lm / 977lm / 811lm	15° / 36° / 50°
			18W	1292lm / 1369lm / 1105lm	15° / 36° / 50°

Driver not included. See recommended drivers on page 506-507.
 Driver no incluido. Ver drivers recomendados en página 506-507.

DEEP L Round

no incl. DIM 355° 30° 50.000hs L80 / B10 MacAdam 2 IP23 18W 25W 39W 500mA 34V 700mA 35V 1050mA 37V 650°C

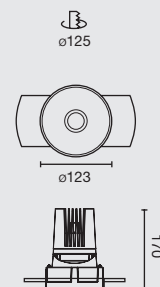

Family

Color T

Beam Angle

Finish

Accessory

30910 Deep L Round	927 2700K CRI90	1 15°	1 White	H Honeycomb
31010 Deep L Round Trimless	930 3000K CRI90	3 36°	2 Black	S Striped Glass
	940 4000K CRI90	6 60°		D Spread Glass
	941 Fashion CRI95			No accessory

30910

927

1

1

H

Example **3091092711H** — Deep L Round 2700K 15° White Honeycomb

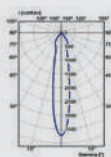

15°



36°

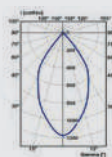

60°

Option	Color T	CRI	Power	Lumen Output	Beam Angle
927	2700K	90	18W	1420lm / 1487lm / 1248lm	15° / 36° / 60°
			25W	1923lm / 1990lm / 1668lm	15° / 36° / 60°
			39W	2551lm / 2845lm / 2361lm	15° / 36° / 60°
930	3000K	90	18W	1464lm / 1534lm / 1287lm	15° / 36° / 60°
			25W	1983lm / 2052lm / 1720lm	15° / 36° / 60°
			39W	2630lm / 2934lm / 2435lm	15° / 36° / 60°
940	4000K	90	18W	1507lm / 1580lm / 1325lm	15° / 36° / 60°
			25W	2042lm / 2113lm / 1771lm	15° / 36° / 60°
			39W	2708lm / 3022lm / 2508lm	15° / 36° / 60°

Driver not included. See recommended drivers on page 506-507.
 Driver no incluido. Ver drivers recomendados en página 506-507.

DEEP L Square

no incl. DIM 355° 30° 50.000hs L80 / B10 MacAdam 2 IP23 18W 500mA 34V 25W 700mA 35V 39W 1050mA 37V 650°C



125x125



125x125

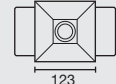

Family

Color T

Beam Angle

Finish

Accessory

31110 Deep L Square	927 2700K CRI90	1 15°	1 White	H Honeycomb
31210 Deep L Square Trimless	930 3000K CRI90	3 36°	2 Black	S Striped Glass
	940 4000K CRI90	6 60°		D Spread Glass
	941 Fashion CRI95			No accessory

30110

927

1

1

H

Example **3011092711H** — Deep L Square 2700K 15° White Honeycomb

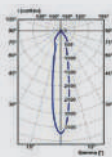

15°

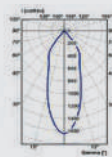

36°

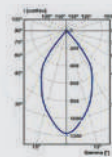

60°

Option	Color T	CRI	Power	Lumen Output	Beam Angle
927	2700K	90	18W	1420lm / 1487lm / 1248lm	15° / 36° / 60°
			25W	1923lm / 1990lm / 1668lm	15° / 36° / 60°
			39W	2551lm / 2845lm / 2361lm	15° / 36° / 60°
930	3000K	90	18W	1464lm / 1534lm / 1287lm	15° / 36° / 60°
			25W	1983lm / 2052lm / 1720lm	15° / 36° / 60°
			39W	2630lm / 2934lm / 2435lm	15° / 36° / 60°
940	4000K	90	18W	1507lm / 1580lm / 1325lm	15° / 36° / 60°
			25W	2042lm / 2113lm / 1771lm	15° / 36° / 60°
			39W	2708lm / 3022lm / 2508lm	15° / 36° / 60°

Driver not included. See recommended drivers on page 506-507.
 Driver no incluido. Ver drivers recomendados en página 506-507.

TROOP is a collection of downlights with infinite options of sizes, formats, finishes and light angles. All this and much more in the palm of your hand.

TROOP es una colección de downlights con infinitas opciones de tamaños, formatos, acabados y ángulos de apertura. Todo esto y mucho más en la palma de tu mano.



TROOP





Residential



Restaurant

Beam Angle

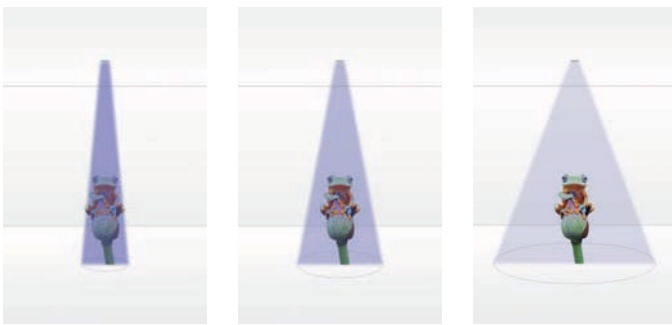

15°

36°

48°

TROOP Collection



Surface
301

MODULE
Modulo

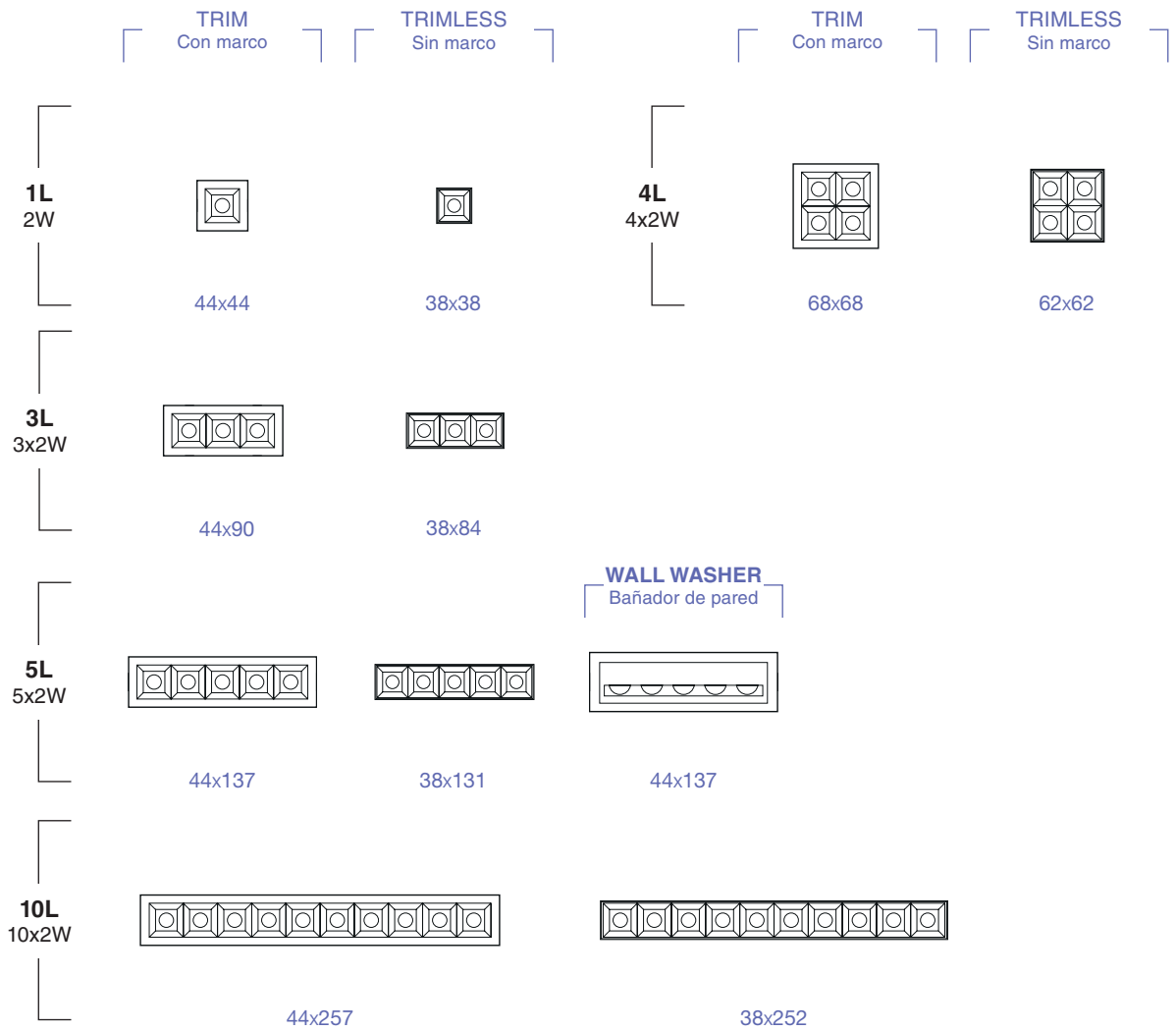

FINISH
Acabado

-  **Black+Black**
Negro+Negro
-  **Black+White**
Negro+Blanco
-  **White+White**
Blanco+Blanco
-  **White+Black**
Blanco+Negro
-  **Black+Gold**
Negro+Oro
-  **White+Gold**
Blanco+Oro

COLOR TEMPERATURE
Temperatura de color

- 2700K CRI90
- 3000K CRI90
- 4000K CRI90

BEAM ANGLE
Ángulo de apertura

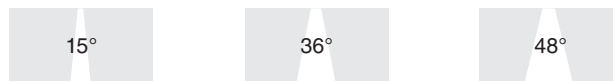

CONTROL SYSTEM
Sistema de control



Highlights

Anti-glare optics

Óptica antideslumbrate

UGR

Reflector with dark light technology

Reflector con tecnología dark light

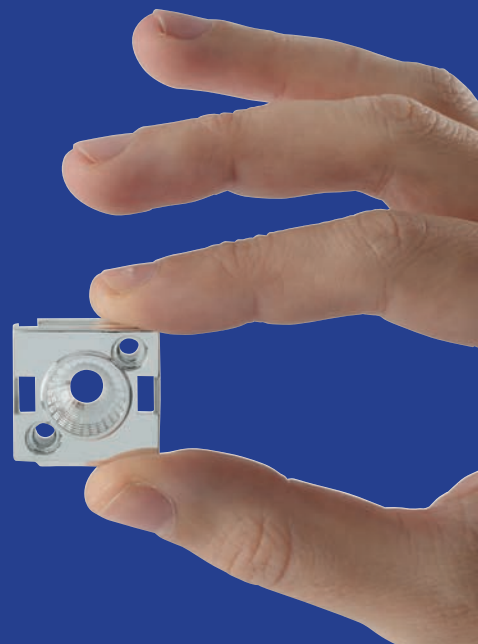
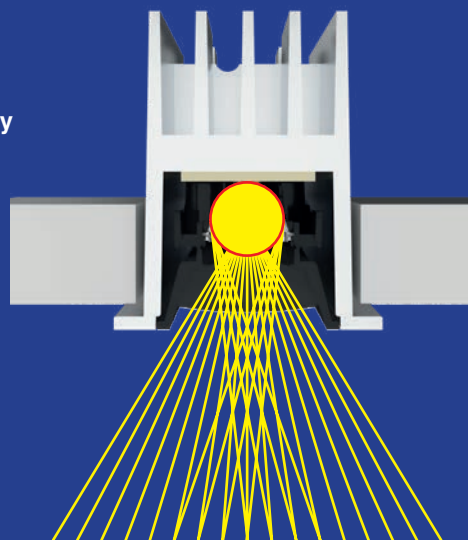

Different Sizes & Finishes
Diversos tamaños y acabados



Linear Design With Circular Light Effect
Diseño lineal con efecto lumínico circular



Wall Washer Version
Versión bañador de pared



Several Color Temperatures
Varias temperaturas de color



TROOP 1L

no incl. DIM 50.000hs L80 / B10 MacAdam 3 700mA 2.85V 650°C UGR <16

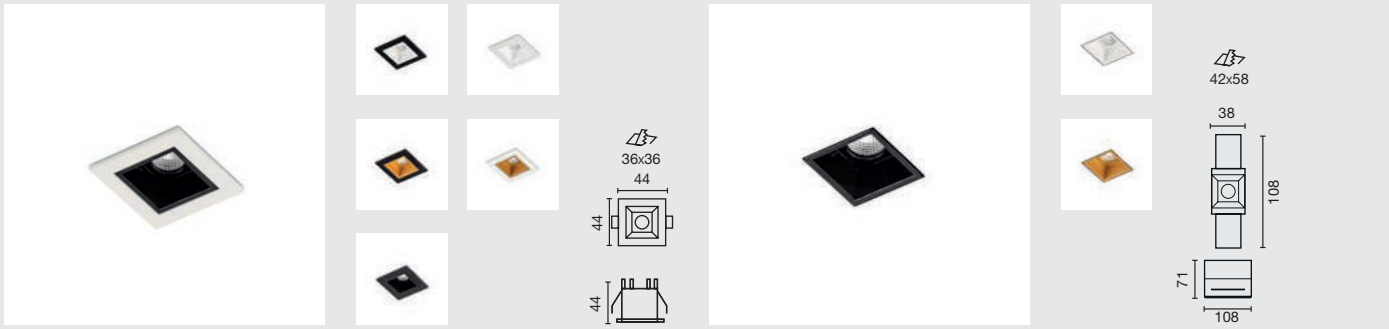

Family	Color T	Beam Angle	Trim	Anti-Glare
43700 Troop Trim 2W	927 2700K CRI90	1 15°	1 White	1 White
	930 3000K CRI90	3 36°	2 Black	2 Black
	940 4000K CRI90	4 48°		4 Gold
43704 Troop Trimless 2W	927 2700K CRI90	1 15°	0 Trimless	1 White
	930 3000K CRI90	3 36°		2 Black
	940 4000K CRI90	4 48°		4 Gold

43700 927 1 1 1

Example **43700927111** — Troop Trim 2W 2700K 15° White White



Option	Color T	CRI	Power	Lumen Output	Beam Angle
927	2700K	90	2W	160lm / 163lm / 166lm	15° / 36° / 48°
930	3000K	90	2W	165lm / 168lm / 171lm	15° / 36° / 48°
940	4000K	90	2W	170lm / 173lm / 176lm	15° / 36° / 48°

Driver not included. See recommended drivers on page 506-507.
 Driver no incluido. Ver drivers recomendados en página 506-507.

TROOP 3L

no incl. DIM 50.000hs L80 / B10 MacAdam 3 700mA 8.61V 650°C UGR <16

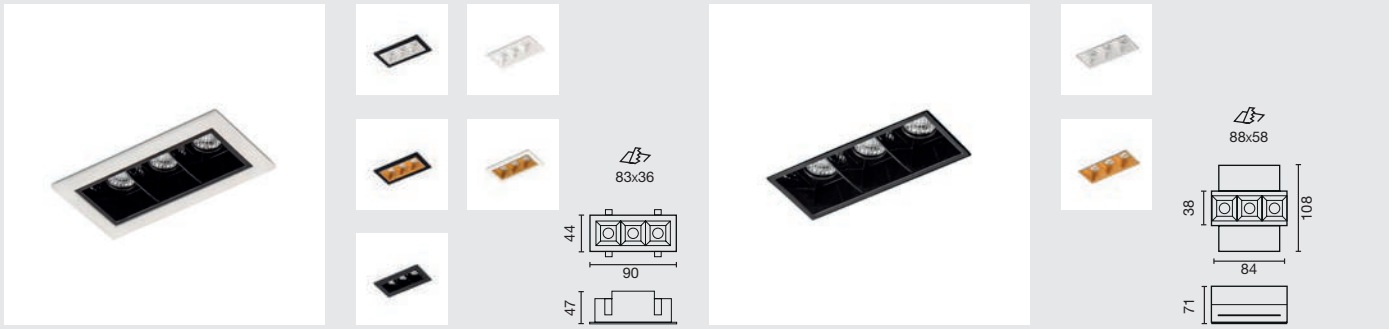

Family	Color T	Beam Angle	Trim	Anti-Glare
43701 Troop Trim 3x2W	927 2700K CRI90	1 15°	1 White	1 White
	930 3000K CRI90	3 36°	2 Black	2 Black
	940 4000K CRI90	4 48°		4 Gold
43705 Troop Trimless 3x2W	927 2700K CRI90	1 15°	0 Trimless	1 White
	930 3000K CRI90	3 36°		2 Black
	940 4000K CRI90	4 48°		4 Gold

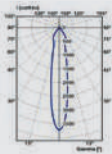

15°

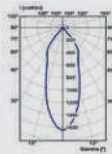

36°

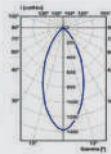

48°

Option	Color T	CRI	Power	Lumen Output	Beam Angle
927	2700K	90	3x2W	425lm / 650lm / 493lm	15° / 36° / 48°
930	3000K	90	3x2W	438lm / 670lm / 508lm	15° / 36° / 48°
940	4000K	90	3x2W	451lm / 690lm / 523lm	15° / 36° / 48°

Driver not included. See recommended drivers on page 506-507.
 Driver no incluido. Ver drivers recomendados en página 506-507.

TROOP 4L

no incl. DIM 50.000hs L80 / B10 MacAdam 3 700mA 14.28V 650°C UGR <16

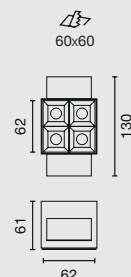
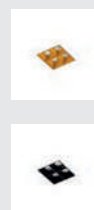
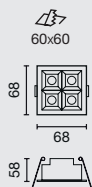
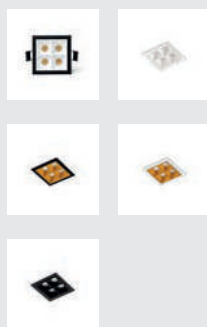

Family	Color T	Beam Angle	Trim	Anti-Glare
43712 Troop Trim 4x2W	927 2700K CRI90	1 15°	1 White	1 White
	930 3000K CRI90	3 36°	2 Black	2 Black
	940 4000K CRI90	4 48°		4 Gold
43713 Troop Trimless 4x2W	927 2700K CRI90	1 15°	0 Trimless	1 White
	930 3000K CRI90	3 36°		2 Black
	940 4000K CRI90	4 48°		4 Gold

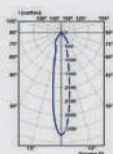

15°

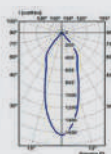

36°



48°

Option	Color T	CRI	Power	Lumen Output	Beam Angle
927	2700K	90	4x2W	488lm / 701lm / 708lm	15° / 36° / 48°
930	3000K	90	4x2W	503lm / 723lm / 730lm	15° / 36° / 48°
940	4000K	90	4x2W	712lm / 891lm / 878lm	15° / 36° / 48°

Driver not included. See recommended drivers on page 506-507.
 Driver no incluido. Ver drivers recomendados en página 506-507.

TROOP 5L

no incl. DIM 50.000hs L80 / B10 MacAdam 3 700mA 14.28V 650°C UGR <16

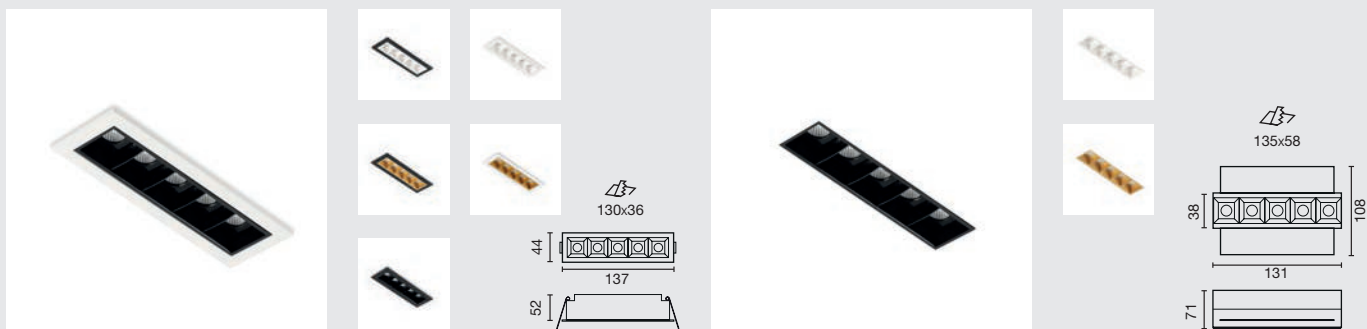

Family	Color T	Beam Angle	Trim	Anti-Glare
43702 Troop Trim 5x2W	927 2700K CRI90	1 15°	1 White	1 White
	930 3000K CRI90	3 36°	2 Black	2 Black
	940 4000K CRI90	4 48°		4 Gold
43706 Troop Trimless 5x2W	927 2700K CRI90	1 15°	0 Trimless	1 White
	930 3000K CRI90	3 36°		2 Black
	940 4000K CRI90	4 48°		4 Gold

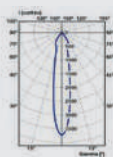

15°

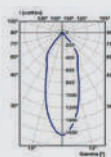

36°



48°

Option	Color T	CRI	Power	Lumen Output	Beam Angle
927	2700K	90	5x2W	672lm / 841lm / 828lm	15° / 36° / 48°
930	3000K	90	5x2W	692lm / 866lm / 853lm	15° / 36° / 48°
940	4000K	90	5x2W	712lm / 891lm / 878lm	15° / 36° / 48°

Driver not included. See recommended drivers on page 506-507.
 Driver no incluido. Ver drivers recomendados en página 506-507.

TROOP WALL WASHER

no incl. DIM 50.000hs L80 / B10 MacAdam 3 700mA 14.28V 650°C UGR <16

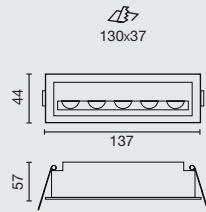

Family	Color T	Beam Angle	Trim	Anti-Glare
43710 Troop Wall Washer 5x2W	927 2700K CRI90	0 Asymmetric	1 White	1 White
	930 3000K CRI90		2 Black	2 Black
	940 4000K CRI90			

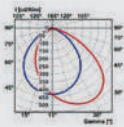

90°

Option	Color T	CRI	Power	Lumen Output	Beam Angle
927	2700K	90	5x2W	519lm	90°
930	3000K	90	5x2W	535lm	90°
940	4000K	90	5x2W	551lm	90°

Driver not included. See recommended drivers on page 506-507.
 Driver no incluido. Ver drivers recomendados en página 506-507.

TROOP 10L

no incl. DIM 50.000hs L80 / B10 MacAdam 3 700mA 28.57V 650°C UGR <16

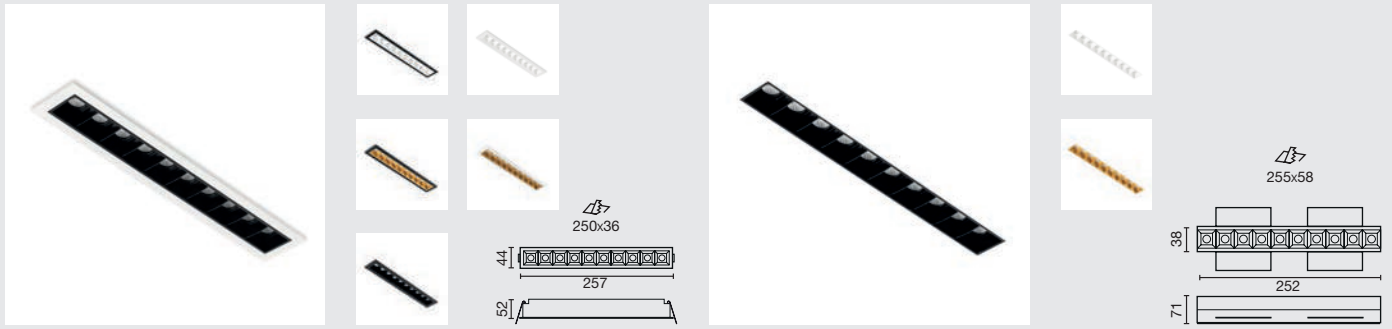

Family	Color T	Beam Angle	Trim	Anti-Glare
43703 Troop Trim 10x2W	927 2700K CRI90	1 15°	1 White	1 White
	930 3000K CRI90	3 36°	2 Black	2 Black
	940 4000K CRI90	4 48°		4 Gold
43707 Troop Trimless 10x2W	927 2700K CRI90	1 15°	0 Trimless	1 White
	930 3000K CRI90	3 36°		2 Black
	940 4000K CRI90	4 48°		4 Gold

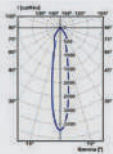

15°

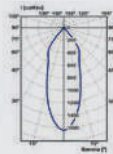

36°



48°

Option	Color T	CRI	Power	Lumen Output	Beam Angle
927	2700K	90	10x2W	1379lm / 1681lm / 1755lm	15° / 36° / 48°
930	3000K	90	10x2W	1422lm / 1733lm / 1809lm	15° / 36° / 48°
940	4000K	90	10x2W	1465lm / 1785lm / 1863lm	15° / 36° / 48°

Driver not included. See recommended drivers on page 506-507.
 Driver no incluido. Ver drivers recomendados en página 506-507.



KIMO

KIMO is a downlight of up to 30W, designed for both accent and general lighting. It is ideal for illuminating spaces with high ceilings, such as car dealerships or entrance halls, providing efficient and powerful lighting to enhance large areas. KIMO combines functionality with versatility, making it a perfect choice for spaces that demand performance.

KIMO es un downlight de hasta 30W, diseñado tanto para iluminación de acento como general. Es ideal para iluminar espacios con techos altos, como concesionarios o halls de entrada, proporcionando una iluminación eficiente y potente para realzar grandes áreas. KIMO combina funcionalidad y versatilidad, siendo la elección perfecta para espacios que requieren un rendimiento destacado.



Residential



Office

Beam Angle



12°



24°

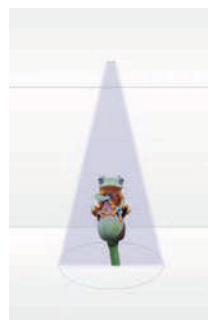

36°

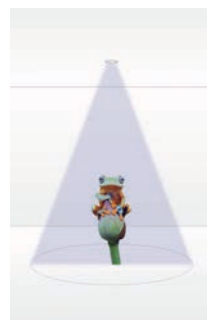

60°

MODULE
Modulo

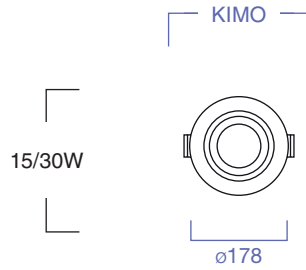

FINISH
Acabado

● **Black**
Negro

○ **White**
Blanco

COLOR TEMPERATURE
Temperatura de color

2700K CRI90

3000K CRI90

4000K CRI90

BEAM ANGLE
Ángulo de apertura

12°

24°

36°

60°

CONTROL SYSTEM
Sistema de control



CASAMBI



Highlights

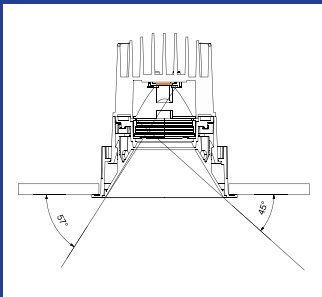

Visual Comfort
Confort Visual



Connectivity
Conectividad

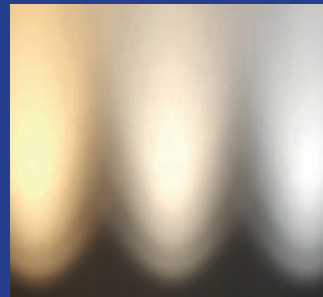

Several Color Temperatures
Varias Temperaturas de Color

KIMO

incl. DIM 50.000hs L80 / B10 MacAdam 3 220-240V 650°C UGR <19

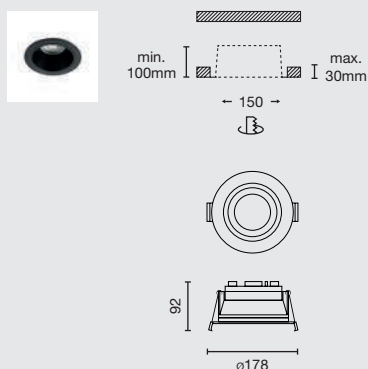

Family	Power	Color T	Beam Angle	Finish	Control System
0360 Kimo	1 15W	927 2700K CRI90	1 15°	1 White	W CASAMBI
	2 30W	930 3000K CRI90	2 24°	2 Black	D
		940 4000K CRI90	3 36°		C
			6 60°		ON/OFF

0360 1 927 1 1 1 W

Example **0360192711W** — Kimo 15W 2700K CRI90 15° White Casambi

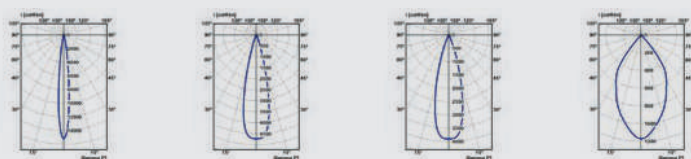

15°

24°

36°

60°

Option	Color T	CRI	Power	Lumen Output	Beam Angle
927	2700K	90	15W	1388lm / 1167lm / 1905lm / 1172lm	15° / 24° / 36° / 50°
			30W	2668lm / 2245lm / 2106lm / 2253lm	15° / 24° / 36° / 50°
930	3000K	90	15W	1431lm / 1111lm / 1042lm / 1115lm	15° / 24° / 36° / 50°
			30W	2751lm / 2314lm / 2171lm / 2323lm	15° / 24° / 36° / 50°
940	3000K	90	15W	1473lm / 1239lm / 1163lm / 1244lm	15° / 24° / 36° / 50°
			30W	2834lm / 2383lm / 2236lm / 2393lm	15° / 24° / 36° / 50°



KOBO

The KOBO downlight is a robust and reliable solution, with an IP65 rating, making it ideal for applications in hospitals and industries where resistance and durability are crucial. With two available beam angles, it can adapt to a wide range of lighting needs, from general illumination to specific tasks. Its solid design and features ensure high performance in demanding environments where light quality is essential.

El downlight KOBO es una solución robusta y confiable, con clasificación IP65 que lo hace ideal para aplicaciones en hospitales e industrias donde la resistencia y la durabilidad son fundamentales. Con dos ángulos de apertura disponibles, se adapta a un sinfín de necesidades de iluminación, desde iluminación general hasta tareas específicas. Su diseño sólido y sus prestaciones garantizan un alto rendimiento en entornos exigentes donde la calidad de la luz es esencial.



MODULE
Modulo

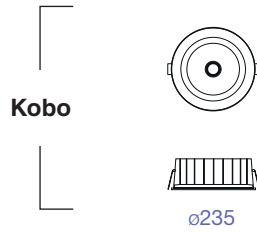

FINISH
Acabado



COLOR TEMPERATURE
Temperatura de color



BEAM ANGLE
Ángulo de apertura



CONTROL SYSTEM
Sistema de control



Highlights

With two options for beam angles, a UGR below 19, and an IP65 protection rating, this downlight becomes the ideal choice for hospital environments. The Tunable White version provides the flexibility to offer circadian cycle lighting.

Con dos opciones de ángulos de apertura, un UGR inferior a 19 y un grado de protección IP65, este downlight se convierte en la opción ideal para entornos hospitalarios. La versión de Tunable White proporciona la flexibilidad de ofrecer iluminación de ciclo circadiano.



IP65

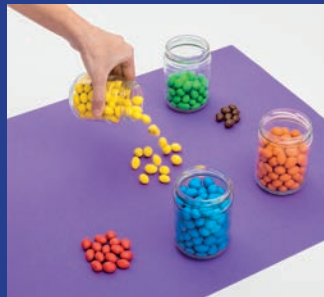

High CRI
Alto IRC

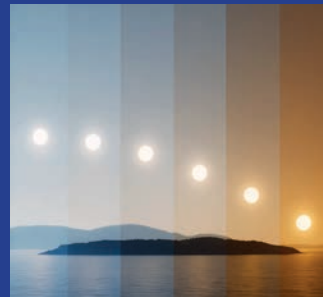

Tunable White

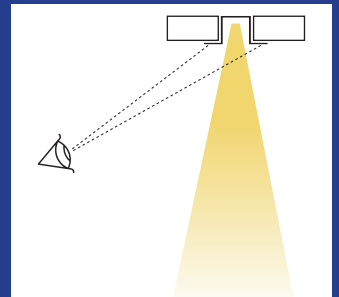

UGR<19



Hospital

Beam Angle

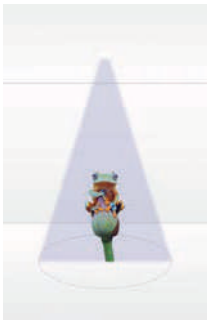

60°

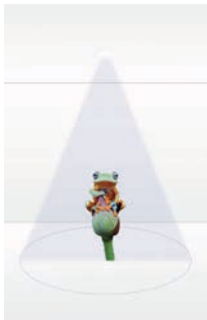

100°

KOBO

incl. DIM 50.000hs L80/L70 / B10 MacAdam 3 IP65 220- 50/ 240V 60Hz 650°C

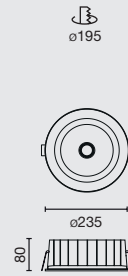

Family	Color T	Beam Angle	Finish	Control System
0354 Kobo 27W	927 2700K CRI90	6 60°	1 White	W CASAMBI
0355 Kobo 27W	930 3000K CRI90	9 100°		D DALI
	940 4000K CRI90			ON/OFF
0354 Kobo 27W	TW 2700-6500K	9 100°	1 White	W CASAMBI
				D DALI

0354 927 6 1 W

Example 035492761W — Kobo 27W 2700K CRI90 60° White Casambi

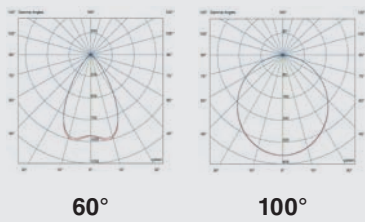

Option	Color T	CRI	Power	Lumen Output	Beam Angle
927	2700K	90	15W	1506/1661lm	60° / 100°
			27W	2394/2640lm	
930	3000K	90	15W	1551/1711lm	60° / 100°
			27W	2468/2722lm	
940	4000K	90	15W	1598/1762lm	60° / 100°
			27W	2542/2804lm	
TW	2000-6000K	90	27W	1672lm	100°





CROC is a family of recessed light fixtures available in 3 different sizes: 100 mm, 135 mm and 180 mm. Its different color temperature options and its microprismatic optics for glare control make it a perfect option for work zones and spaces dedicated to healthcare. It has IP44 for humid zones and a low recess height.

CROC es una familia de luminarias empotrables disponible en 3 tamaños diferentes. Sus diferentes opciones de temperatura de color y su óptica micro prismática para el control del deslumbramiento la convierten en una opción perfecta para zonas de trabajo y espacios dedicados a la salud. Presenta IP44 para zonas húmedas y una baja cota de empotramiento.



CROC



MODULE
Modulo

Croc
9W



ø100

Croc
13W

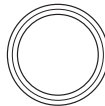

ø135

Croc
13 / 19W

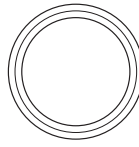

ø180

FINISH
Acabado

White
Blanco

COLOR TEMPERATURE
Temperatura de color

2700K CRI90

3000K CRI90

4000K CRI90

2700-6500K

BEAM ANGLE
Ángulo de apertura



CONTROL SYSTEM
Sistema de control



CASAMBI



Highlights



Different sizes
Diversos tamaños



Micro-prismatic optics
Óptica micro prismática



IP 54/44



Low Recessed Profile
Empotramiento de Baja
Profundidad

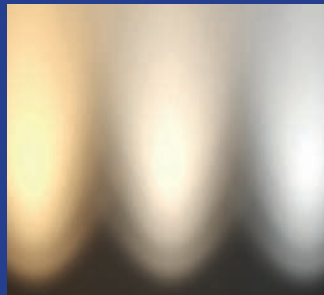

Several color temperatures
Varias temperaturas de color

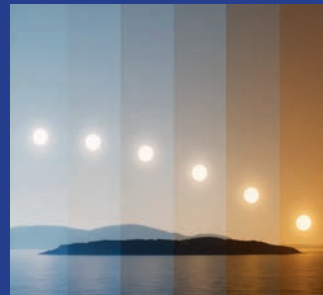

Tunable White

CROC 9W

incl. DIM 50.000hs L70 / B10 MacAdam 3 IP 54/44 220- 50/ 240V 60Hz 650°C

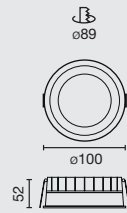

Family	Color T	Beam Angle	Finish	Control System
43780 CROC 9W	927 2700K CRI90	9 90°	1 White	W CASAMBI
	930 3000K CRI90			D DALI
	940 4000K CRI90			C TRIAC
				ON/OFF

43780 927 9 1 W

Example 4378092791W — CROC 9W 2700K 90° White Casambi

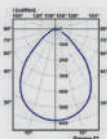

90°

Option	Color T	CRI	Power	Lumen Output	Beam Angle
927	2700K	90	13W	1009lm	90°
930	3000K	90	13W	1039lm	90°
940	4000K	90	13W	1070lm	90°

CROC 13W

incl. DIM 50.000hs L70 / B10 MacAdam 3 IP 54/44 220- 50/ 240V 60Hz 650°C

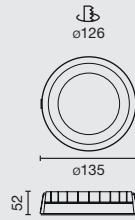

Family	Color T	Beam Angle	Finish	Control System
43781 CROC 13W	927 2700K CRI90 930 3000K CRI90 940 4000K CRI90	9 90°	1 White	W CASAMBI D DALI C TRIAC ON/OFF

43781 927 9 1 W

Example **4378192791W** — CROC 13W 2700K 90° White Casambi

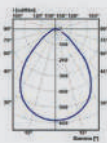

90°

Option	Color T	CRI	Power	Lumen Output	Beam Angle
927	2700K	90	13W	1409lm	90°
930	3000K	90	13W	1452lm	90°
940	4000K	90	13W	1495lm	90°

CROC 13/19W

incl. DIM 50.000hs L70 / B10 MacAdam 3 IP 54/44 220- 50/ 240V 60Hz 650°C

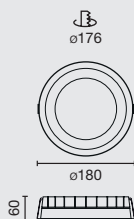

Family	Color T	Beam Angle	Finish	Control System								
43782 Croc 19W	927 2700K CRI90	9 90°	1 White	<table border="1"> <tr><td>W</td><td>CASAMBI</td></tr> <tr><td>D</td><td></td></tr> <tr><td>C</td><td></td></tr> <tr><td></td><td>ON/OFF</td></tr> </table>	W	CASAMBI	D		C			ON/OFF
W	CASAMBI											
D												
C												
	ON/OFF											
43783 Croc 13W UGR<19	930 3000K CRI90 940 4000K CRI90											
43784 Croc 19W Ø180	TW 2700-6500K	9 90°	1 White	<table border="1"> <tr><td>W</td><td>CASAMBI</td></tr> <tr><td>D</td><td></td></tr> </table>	W	CASAMBI	D					
W	CASAMBI											
D												

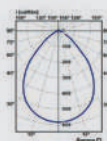

90°

Option	Color T	CRI	Power	Lumen Output	Beam Angle
927	2700K	90	19W	2681lm	90°
930	3000K	90	19W	2762lm	90°
940	4000K	90	19W	2844lm	90°
TW	2000-6500K	90	19W	1773lm	90°

UGR<19					
Option	Color T	CRI	Power	Lumen Output	Beam Angle
927	2700K	90	13W	1616lm	90°
930	3000K	90	13W	1665lm	90°
940	4000K	90	13W	1662lm	90°



Luminaire in a round adjustable format.
This family of luminaires is manufactured in
different sizes and powers so it is easy to find
the one that best suits your lighting needs.

Luminaria de formato redondo orientable.
Esta familia de luminarias se fabrica en
diferentes tamaños y potencias por lo que es
fácil encontrar la que más se ajuste a vuestras
necesidades de iluminación.

OPTIC





MODULE
Modulo

Optic Mini
18 / 25W



ø140

Optic
24 / 36W



ø165

FINISH
Acabado

● **Black**
Negro

○ **White**
Blanco

● **Grey**
Gris

COLOR TEMPERATURE
Temperatura de color

2700K CRI82

3000K CRI85

4000K CRI85

2700K CRI95

3000K CRI95

4000K CRI95

MEAT

BREAD

FASHION

BEAM ANGLE
Ángulo de apertura

20°

56°

CONTROL SYSTEM
Sistema de control



CASAMBI



Highlights



Different Sizes
Diversos tamaños



Cardanic Orientation
Orientación cardánica



High CRI
Alto IRC



Several Color Temperatures
Varias temperaturas de color

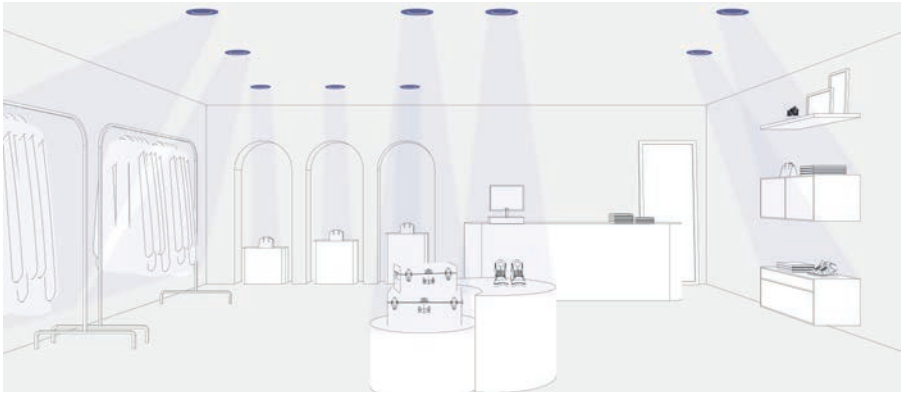

Retail

Beam Angle

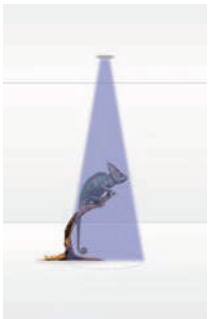

20°

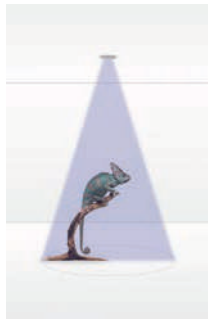

56°

OPTIC MINI

no incl. DIM 20° 50.000hs L80 / B10 MacAdam 3 18W 25W 500mA 33V 700mA 34V 650°C

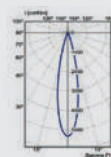
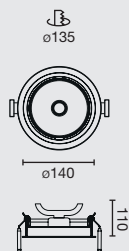
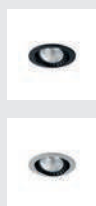

20°

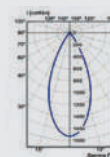

56°

Family

Color T

Finish

03250 Optic Mini 18/25W

- 300** 2700K CRI82 20°
- 310** 2700K CRI82 56°
- 320** 3000K CRI85 20°
- 330** 3000K CRI85 56°
- 340** 4000K CRI85 20°
- 350** 4000K CRI85 56°

- 1** White
- 2** Black
- 3** Grey

03250 CRI95

- 360** 2700K CRI95 20°
- 370** 2700K CRI95 56°
- 380** 3000K CRI95 20°
- 390** 3000K CRI95 56°
- 400** 4000K CRI95 20°
- 410** 4000K CRI95 56°

- 1** White
- 2** Black
- 3** Grey

03250 Food

- 481** BREAD 2500K CRI88 20°
- 491** BREAD 2500K CRI88 56°
- 501** MEAT CRI82 20°
- 511** MEAT CRI82 56°

- 1** White
- 2** Black
- 3** Grey

03250 Fashion

- 541** 3100K CRI95 20°
- 551** 3100K CRI95 56°

- 1** White
- 2** Black
- 3** Grey

03250

300

1

Example **032503001** — Optic Mini 18W 2700K CRI82 20° White

Color T	CRI	Power	Lumen Output	Beam Angle
2700K	82	18W / 25W	1642lm / 2193lm	20° / 56°
	95		1361lm / 1882lm	
3000K	85	18W / 25W	1693lm / 2261lm	20° / 56°
	95		1403lm / 1878lm	
4000K	85	18W / 25W	1744lm / 2329lm	20° / 56°
	95		1445lm / 1934lm	
MEAT	82	18W / 25W	1335lm	20° / 56°
BREAD 2500K	88	18W / 25W	1801lm	20° / 56°
FASHION 3100K	95	18W / 25W	1841lm	20° / 56°

Driver not included. See recommended drivers on page 506-507.
 Driver no incluido. Ver drivers recomendados en página 506-507.

OPTIC

no incl. DIM 20° 50.000hs L80 / B10 MacAdam 3 24W 36W 700mA 33V 1050mA 34V 650°C

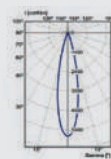
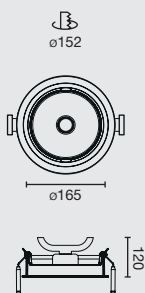

20°

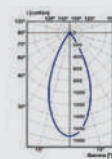

56°

Family

Color T

Finish

03200 Optic 24/36W

- 300** 2700K CRI82 20°
- 310** 2700K CRI82 56°
- 320** 3000K CRI85 20°
- 330** 3000K CRI85 56°
- 340** 4000K CRI85 20°
- 350** 4000K CRI85 56°

- 1** White
- 2** Black

03200 CRI95

- 360** 2700K CRI95 20°
- 370** 2700K CRI95 56°
- 380** 3000K CRI95 20°
- 390** 3000K CRI95 56°
- 400** 4000K CRI95 20°
- 410** 4000K CRI95 56°

- 1** White
- 2** Black

03200 Food

- 481** BREAD 2500K CRI88 20°
- 491** BREAD 2500K CRI88 56°
- 501** MEAT CRI82 20°
- 511** MEAT CRI82 56°

- 1** White
- 2** Black

03200 Fashion

- 541** 3100K CRI95 20°
- 551** 3100K CRI95 56°

- 1** White
- 2** Black

Color T	CRI	Power	Lumen Output	Beam Angle
2700K	82	24 / 36W	2167lm / 3066lm	20° / 56°
	95		2072lm / 2930lm	
3000K	85	24 / 36W	2234lm / 3161lm	20° / 56°
	95		2136lm / 3021lm	
4000K	85	24 / 36W	2301lm / 3256lm	20° / 56°
	95		2200lm / 3112lm	
MEAT	82	24 / 36W	1406lm / 2023lm	20° / 56°
BREAD 2500K	88	24 / 36W	1912lm / 2750lm	20° / 56°
FASHION 3100K	95	24 / 36W	1977lm / 2844lm	20° / 56°

Driver not included. See recommended drivers on page 506-507.
 Driver no incluido. Ver drivers recomendados en página 506-507.



COLIN is a series of adjustable square/ rectangular luminaires, available in 1, 2, or 3 light versions.. This family of luminaires is manufactured in different sizes and power so it is easy to find one that fits best to your lighting needs.

COLIN es una serie de luminarias orientables de formato cuadrado/rectangular disponible para 1, 2 o 3 lámparas. La familia ofrece diferentes opciones de tamaños y potencias por lo que es fácil encontrar la que más se ajuste a vuestras necesidades de iluminación.



COLIN



MODULE

Modulo

TRIM
Con marco

TRIMLESS
Sin marco

Colin Nano
7 / 13W



113x113



113x223



100x100



100x210

Colin Mini
18 / 25W



140x140



140x295

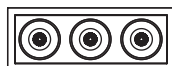

140x435

Colin
24 / 36W



173x173

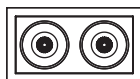

173x343

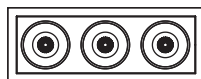

173x512

FINISH

Acabado



COLOR TEMPERATURE

Temperatura de color

2700K CRI82

3000K CRI85

4000K CRI85

2700K CRI95

3000K CRI95

4000K CRI95

MEAT

BREAD

FASHION

BEAM ANGLE

Ángulo de apertura

20°

56°

CONTROL SYSTEM

Sistema de control



CASAMBI



Highlights

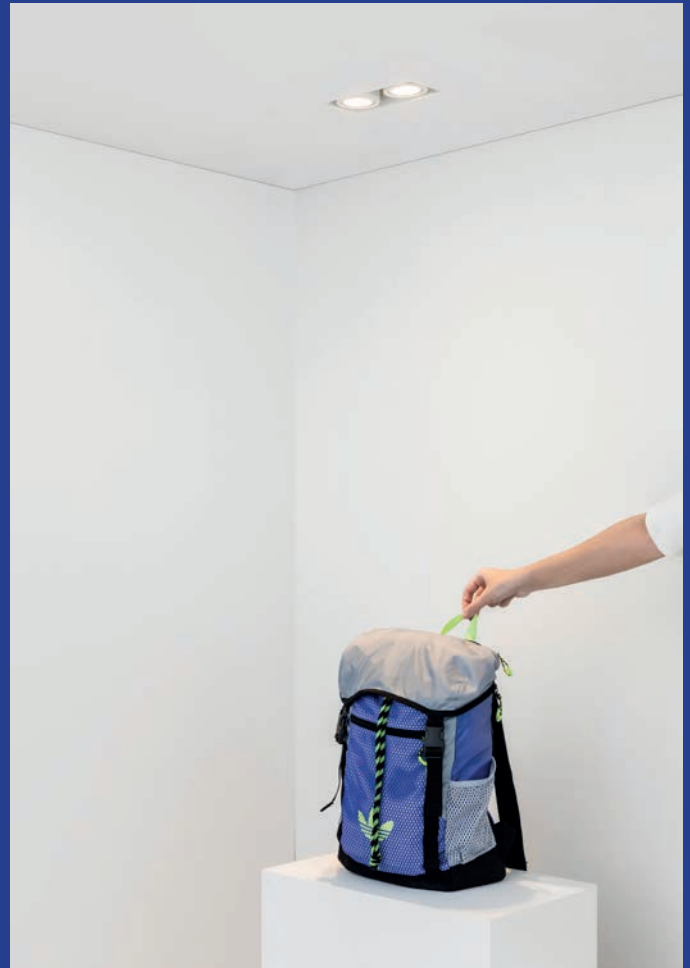

Different Sizes
Diversos Tamaños



Cardanic Orientation
Orientación Cardánic



High CRI
Alto IRC



Several Color Temperatures
Varias Temperaturas de Color

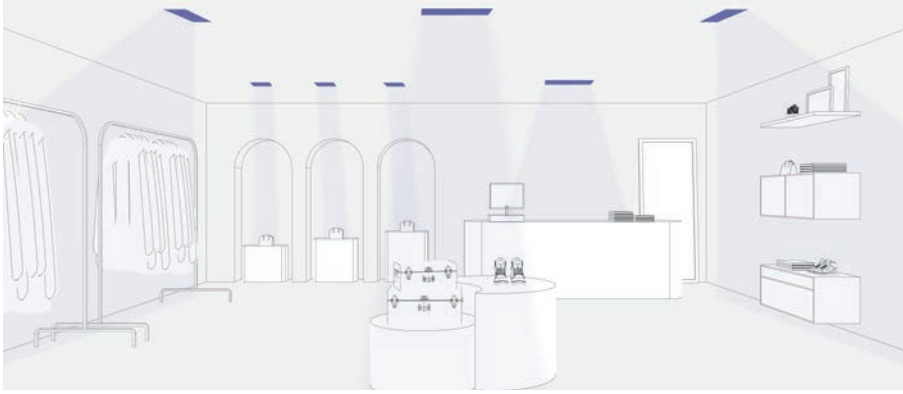

Retail

Beam Angle

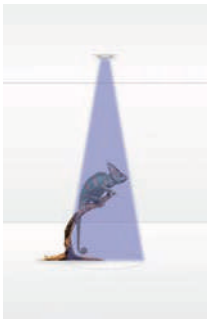

20°

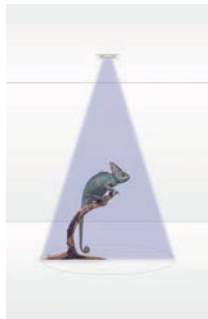

56°

COLIN NANO 1L

no incl. DIM 20° 50.000hs L80 / B10 MacAdam 3 7W 13W 200mA 34V 350mA 35V 650°C

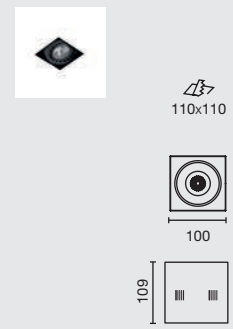
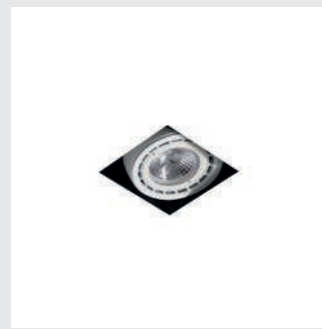
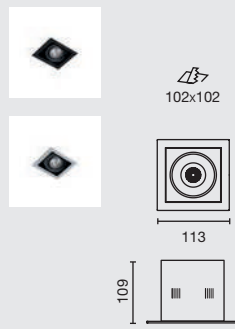
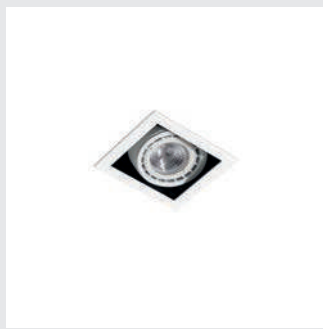

Family

035000	Colin Nano 7/13W
035100	Colin Nano Trimless 7/13W

Color T

10	2700K CRI82 20°
20	2700K CRI82 56°
30	3000K CRI85 20°
40	3000K CRI85 56°
50	4000K CRI85 20°
60	4000K CRI85 56°

Finish

1	White
2	Black
3	Grey (available only for trim)

035000

10

1

Example **035000101** — Colin Nano 7W 2700K CRI82 20° White

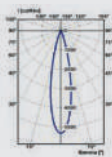

20°

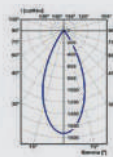

56°

Color T	CRI	Power	Lumen Output	Beam Angle
2700K	82	7W / 13W	691lm / 1120lm	20° / 56°
3000K	85	7W / 13W	712lm / 1155lm	20° / 56°
4000K	85	7W / 13W	733lm / 1190lm	20° / 56°

Driver not included. See recommended drivers on page 506-507.
 Driver no incluido. Ver drivers recomendados en página 506-507.

COLIN NANO 2L

no incl. DIM 20° 50.000hs L80 / B10 MacAdam 3 2x7W 200mA 34V 2x13W 350mA 35V 650°C

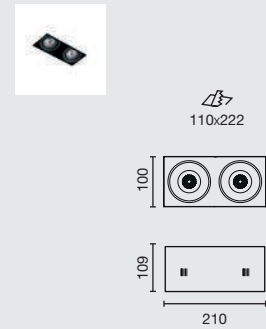
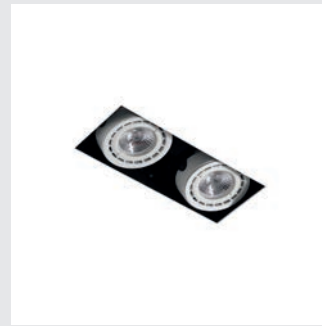
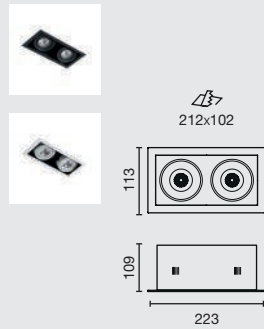

Family

035005	Colin Nano 2L 14/26W
035105	Colin Nano 2L Trimless 14/26W

Color T

00	2700K CRI82 20°
10	2700K CRI82 56°
20	3000K CRI85 20°
30	3000K CRI85 56°
40	4000K CRI85 20°
50	4000K CRI85 56°

Finish

1	White
2	Black
3	Grey (available only for trim)

035005

10

1

Example **035005101** — Colin Nano 14W 2700K CRI82 56° White

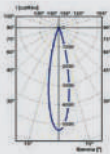

20°



56°

Color T	CRI	Power	Lumen Output	Beam Angle
2700K	82	2x7W / 2x13W	2x691lm / 2x1120lm	20° / 56°
3000K	85	2x7W / 2x13W	2x712lm / 2x1155lm	20° / 56°
4000K	85	2x7W / 2x13W	2x733lm / 2x1190lm	20° / 56°

Driver not included. See recommended drivers on page 506-507.
 Driver no incluido. Ver drivers recomendados en página 506-507.

COLIN MINI 1L

no incl. DIM 20° 50.000hs L80 / B10 MacAdam 3 18W 25W 500mA 33V 700mA 34V 650°C

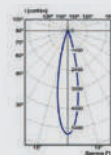
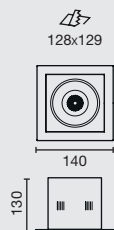
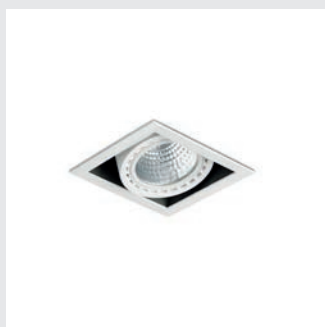

20°

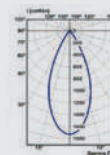

56°

Family

Color T

Finish

033008 Colin Mini 18/25W

- 30** 2700K CRI82 20°
- 40** 2700K CRI82 56°
- 50** 3000K CRI85 20°
- 60** 3000K CRI85 56°
- 70** 4000K CRI85 20°
- 80** 4000K CRI85 56°

- 1** White
- 2** Black
- 3** Grey

03300 CRI95

- 890** 2700K CRI95 20°
- 900** 2700K CRI95 56°
- 910** 3000K CRI95 20°
- 920** 3000K CRI95 56°
- 930** 4000K CRI95 20°
- 940** 4000K CRI95 56°

- 1** White
- 2** Black
- 3** Grey

03301 Food

- 011** BREAD 2500K CRI88 20°
- 021** BREAD 2500K CRI88 56°
- 031** MEAT CRI82 20°
- 041** MEAT CRI82 56°

- 1** White
- 2** Black
- 3** Grey

03301 Fashion

- 050** 3100K CRI95 20°
- 060** 3100K CRI95 56°

- 1** White
- 2** Black
- 3** Grey

Color T	CRI	Power	Lumen Output	Beam Angle
2700K	82	18W / 25W	1642lm / 2193lm	20° / 56°
	95		1361lm / 1882lm	
3000K	85	18W / 25W	1693lm / 2261lm	20° / 56°
	95		1403lm / 1878lm	
4000K	85	18W / 25W	1744lm / 2329lm	20° / 56°
	95		1445lm / 1934lm	
MEAT	82	18W / 25W	1335lm	20° / 56°
BREAD 2500K	88	18W / 25W	1801lm	20° / 56°
FASHION 3100K	95	18W / 25W	1841lm	20° / 56°

Driver not included. See recommended drivers on page 506-507.
 Driver no incluido. Ver drivers recomendados en página 506-507.

COLIN MINI 2L

no incl. DIM 20° 50.000hs L80 / B10 MacAdam 3 2x18W 2x25W 500mA 33V 700mA 34V 650°C

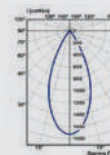
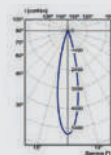
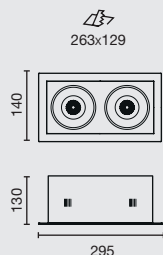
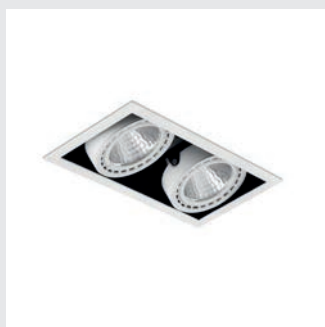

20°

56°

Family

Color T

Finish

03301 Colin Mini 2L 36/50W

- 090** 2700K CRI82 20°
- 100** 2700K CRI82 56°
- 110** 3000K CRI85 20°
- 120** 3000K CRI85 56°
- 130** 4000K CRI85 20°
- 140** 4000K CRI85 56°

- 1** White
- 2** Black
- 3** Grey

03301 CRI95

- 150** 2700K CRI95 20°
- 160** 2700K CRI95 56°
- 170** 3000K CRI95 20°
- 180** 3000K CRI95 56°
- 190** 4000K CRI95 20°
- 200** 4000K CRI95 56°

- 1** White
- 2** Black
- 3** Grey

03301 Food

- 271** BREAD 2500K CRI88 20°
- 281** BREAD 2500K CRI88 56°
- 291** MEAT CRI82 20°
- 301** MEAT CRI82 56°

- 1** White
- 2** Black
- 3** Grey

03301 Fashion

- 330** 3100K CRI95 20°
- 340** 3100K CRI95 56°

- 1** White
- 2** Black
- 3** Grey

Color T	CRI	Power	Lumen Output	Beam Angle
2700K	82	2x18W / 2x25W	2x1642lm / 2x2193lm	20° / 56°
	95		2x1361lm / 2x1882lm	
3000K	82	2x18W / 2x25W	2x1693lm / 2x2261lm	20° / 56°
	95		2x1403lm / 2x1878lm	
4000K	82	2x18W / 2x25W	2x1744lm / 2x2329lm	20° / 56°
	95		2x1445lm / 2x1934lm	
MEAT	82	2x18W / 2x25W	2x1335lm	20° / 56°
BREAD 2500K	88	2x18W / 2x25W	2x1801lm	20° / 56°
FASHION 3100K	95	2x18W / 2x25W	2x1841lm	20° / 56°

Driver not included. See recommended drivers on page 506-507.
 Driver no incluido. Ver drivers recomendados en página 506-507.

COLIN MINI 3L

no incl. DIM 20° 50.000hs L80 / B10 MacAdam 3 3x18W 3x25W 500mA 33V 700mA 34V 650°C

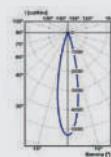
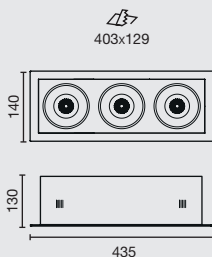

20°

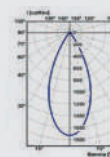

56°

Family

Color T

Finish

03301 Colin Mini 3L 54/75W

- 350** 2700K CRI82 20°
- 360** 2700K CRI82 56°
- 370** 3000K CRI85 20°
- 380** 3000K CRI85 56°
- 390** 4000K CRI85 20°
- 400** 4000K CRI85 56°

- 1** White
- 2** Black
- 3** Grey

03301 CRI95

- 410** 2700K CRI95 20°
- 420** 2700K CRI95 56°
- 430** 3000K CRI95 20°
- 440** 3000K CRI95 56°
- 450** 4000K CRI95 20°
- 460** 4000K CRI95 56°

- 1** White
- 2** Black
- 3** Grey

03301 Food

- 531** BREAD 2500K CRI88 20°
- 541** BREAD 2500K CRI88 56°
- 551** MEAT CRI82 20°
- 561** MEAT CRI82 56°

- 1** White
- 2** Black
- 3** Grey

03301 Fashion

- 590** 3100K CRI95 20°
- 600** 3100K CRI95 56°

- 1** White
- 2** Black
- 3** Grey

Color T	CRI	Power	Lumen Output	Beam Angle
2700K	82	3x18W / 3x25W	3x1642lm / 3x2193lm	20° / 56°
	95		3x1361lm / 3x1882lm	
3000K	82	3x18W / 3x25W	3x1693lm / 3x2261lm	20° / 56°
	95		3x1403lm / 3x1878lm	
4000K	82	3x18W / 3x25W	3x1744lm / 3x2329lm	20° / 56°
	95		3x1445lm / 3x1934lm	
MEAT	82	3x18W / 3x25W	3x1335lm	20° / 56°
BREAD 2500K	88	3x18W / 3x25W	3x1801lm	20° / 56°
FASHION 3100K	95	3x18W / 3x25W	3x1841lm	20° / 56°

Driver not included. See recommended drivers on page 506-507.
 Driver no incluido. Ver drivers recomendados en página 506-507.

COLIN 1L

no incl. DIM 20° 50.000hs L80 / B10 MacAdam 3 24W 36W 700mA 33V 1050mA 34V 650°C

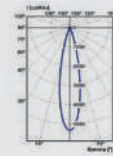
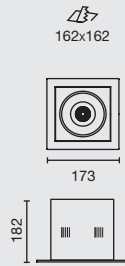

20°

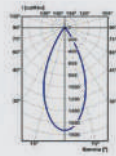

56°

Family

Color T

Finish

03400 Colin 24/36W

- 850** 2700K CRI82 20°
- 860** 2700K CRI82 56°
- 870** 3000K CRI85 20°
- 880** 3000K CRI85 56°
- 890** 4000K CRI85 20°
- 900** 4000K CRI85 56°

- 1** White
- 2** Black
- 3** Grey

03400 CRI95

- 910** 2700K CRI95 20°
- 920** 2700K CRI95 56°
- 930** 3000K CRI95 20°
- 940** 3000K CRI95 56°
- 950** 4000K CRI95 20°
- 960** 4000K CRI95 56°

- 1** White
- 2** Black
- 3** Grey

03401 Food

- 031** BREAD 2500K CRI88 20°
- 041** BREAD 2500K CRI88 56°
- 051** MEAT CRI82 20°
- 061** MEAT CRI82 56°

- 1** White
- 2** Black
- 3** Grey

03401 Fashion

- 090** 3100K CRI95 20°
- 100** 3100K CRI95 56°

- 1** White
- 2** Black
- 3** Grey

0340040 Colin QR-111 LED G53 12V max.12W

- 1** White
- 2** Black
- 3** Grey

Color T	CRI	Power	Lumen Output	Beam Angle
2700K	82	24 / 36W	2167lm / 3066lm	20° / 56°
	95		2072lm / 2930lm	
3000K	85	24 / 36W	2234lm / 3161lm	20° / 56°
	95		2136lm / 3021lm	
4000K	85	24 / 36W	2301lm / 3256lm	20° / 56°
	95		2200lm / 3112lm	
MEAT	82	24 / 36W	1406lm / 2023lm	20° / 56°
BREAD 2500K	88	24 / 36W	1912lm / 2750lm	20° / 56°
FASHION 3100K	95	24 / 36W	1977lm / 2844lm	20° / 56°

Driver not included. See recommended drivers on page 506-507.
 Driver no incluido. Ver drivers recomendados en página 506-507.

COLIN 2L

no incl. DIM 20° 50.000hs L80 / B10 MacAdam 3 2x24W 2x36W 700mA 33V 1050mA 34V 650°C

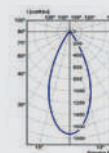
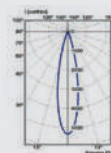
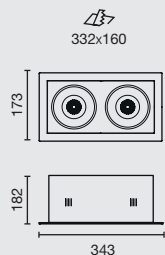
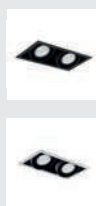

20°

56°

Family

Color T

Finish

03401 Colin 3L 48/72W

- 110** 2700K CRI82 20°
- 120** 2700K CRI82 56°
- 130** 3000K CRI85 20°
- 140** 3000K CRI85 56°
- 150** 4000K CRI85 20°
- 160** 4000K CRI85 56°

- 1** White
- 2** Black
- 3** Grey

03401 CRI95

- 170** 2700K CRI95 20°
- 180** 2700K CRI95 56°
- 190** 3000K CRI95 20°
- 200** 3000K CRI95 56°
- 210** 4000K CRI95 20°
- 220** 4000K CRI95 56°

- 1** White
- 2** Black
- 3** Grey

03401 Food

- 291** BREAD 2500K CRI88 20°
- 301** BREAD 2500K CRI88 56°
- 311** MEAT CRI82 20°
- 321** MEAT CRI82 56°

- 1** White
- 2** Black
- 3** Grey

03401 Fashion

- 350** 3100K CRI95 20°
- 360** 3100K CRI95 56°

- 1** White
- 2** Black
- 3** Grey

0340050 Colin 2L QR-111 LED G53 12V max.12W

- 1** White
- 2** Black
- 3** Grey

Color T	CRI	Power	Lumen Output	Beam Angle
2700K	82	2x24 / 2x36W	2x2167lm / 2x3066lm	20° / 56°
	95		2x2072lm / 2x2930lm	
3000K	85	2x24 / 2x36W	2x2234lm / 2x3161lm	20° / 56°
	95		2x2136lm / 2x3021lm	
4000K	85	2x24 / 2x36W	2x2301lm / 2x3256lm	20° / 56°
	95		2x2200lm / 2x3112lm	
MEAT	82	2x24 / 2x36W	2x1406lm / 2x2023lm	20° / 56°
BREAD 2500K	88	2x24 / 2x36W	2x1912lm / 2x2750lm	20° / 56°
FASHION 3100K	95	2x24 / 2x36W	2x1977lm / 2x2844lm	20° / 56°

Driver not included. See recommended drivers on page 506-507.
 Driver no incluido. Ver drivers recomendados en página 506-507.

COLIN 3L

no incl. DIM 20° 50.000hs L80 / B10 MacAdam 3 3x24W 3x36W 700mA 33V 1050mA 34V 650°C

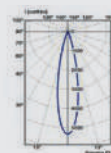
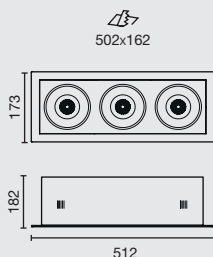

20°

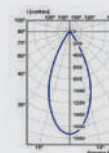

56°

Family

Color T

Finish

03401 Colin 3L 72/108W

- 370** 2700K CRI82 20°
- 380** 2700K CRI82 56°
- 390** 3000K CRI85 20°
- 400** 3000K CRI85 56°
- 410** 4000K CRI85 20°
- 420** 4000K CRI85 56°

- 1** White
- 2** Black
- 3** Grey

03401 CRI95

- 430** 2700K CRI95 20°
- 440** 2700K CRI95 56°
- 450** 3000K CRI95 20°
- 460** 3000K CRI95 56°
- 470** 4000K CRI95 20°
- 480** 4000K CRI95 56°

- 1** White
- 2** Black
- 3** Grey

03401 Food

- 551** BREAD 2500K CRI88 20°
- 561** BREAD 2500K CRI88 56°
- 571** MEAT CRI82 20°
- 581** MEAT CRI82 56°

- 1** White
- 2** Black
- 3** Grey

03401 Fashion

- 610** 3100K CRI95 20°
- 620** 3100K CRI95 56°

- 1** White
- 2** Black
- 3** Grey

0340060 Colin 3L QR-111 LED G53 12V max.12W

- 1** White
- 2** Black
- 3** Grey

Color T	CRI	Power	Lumen Output	Beam Angle
2700K	82	3x24 / 3x36W	3x2167lm / 3x3066lm	20° / 56°
	95		3x2072lm / 3x2930lm	
3000K	85	3x24 / 3x36W	3x2234lm / 3x3161lm	20° / 56°
	95		3x2136lm / 3x3021lm	
4000K	85	3x24 / 3x36W	3x2301lm / 3x3256lm	20° / 56°
	95		3x2200lm / 3x3112lm	
MEAT	82	3x24 / 3x36W	3x1406lm / 3x2023lm	20° / 56°
BREAD 2500K	88	3x24 / 3x36W	3x1912lm / 3x2750lm	20° / 56°
FASHION 3100K	95	3x24 / 3x36W	3x1977lm / 3x2844lm	20° / 56°

Driver not included. See recommended drivers on page 506-507.
 Driver no incluido. Ver drivers recomendados en página 506-507.



FOST

RECESSED

Recessed projector with an optical block designed to meet the highest requirements of accent lighting. This product offers an elegant and efficient solution to highlight specific spaces, providing exceptional quality accent lighting. Its recessed design makes it ideal for discreet integration into various environments, ensuring optimal performance in creating accentuated lighting effects.

Proyector empotrable con un bloque óptico diseñado para satisfacer las más altas exigencias de iluminación de acento. Este producto ofrece una solución elegante y eficiente para resaltar espacios específicos, proporcionando una iluminación de calidad excepcional. Su diseño empotrable lo hace ideal para integrarse de manera discreta en diversos entornos, garantizando un rendimiento óptimo en la creación de efectos de iluminación acentuada.



FOST Collection



Track
41



Pulldown
231



Surface
333



Ceiling
343



Suspended
391

MODULE

Modulo

Fost Recessed
7W / 15W

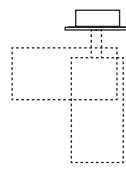

ø50

FINISH

Acabado

● **Black**
Negro

○ **White**
Blanco

COLOR TEMPERATURE

Temperatura de color

2700K CRI90

3000K CRI90

4000K CRI90

2700K CRI97

3000K CRI97

4000K CRI97

BEAM ANGLE

Ángulo de apertura

12°

20°

36°

ACCESSORIES

Accesorios



White Ring



Copper Ring

CONTROL SYSTEM

Sistema de control



CASAMBI

Highlights

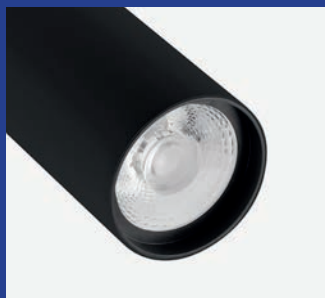

Anti-glare
Anti Deslumbramiento

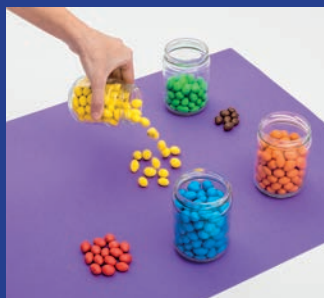

High CRI
Alto IRC



Several Color Temperatures
Varias Temperaturas de Color

Accessories



White Ring
Anillo Blanco



Copper Ring
Anillo Cobre

	White Ring	Copper Ring
ø50	011600099	011600098

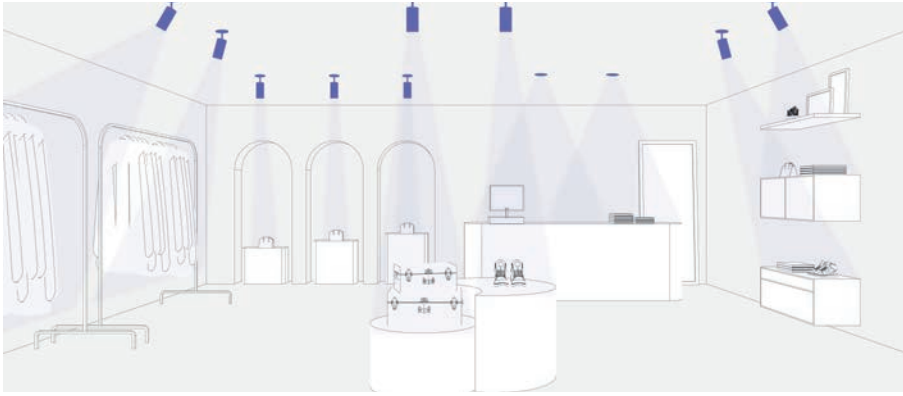

Retail

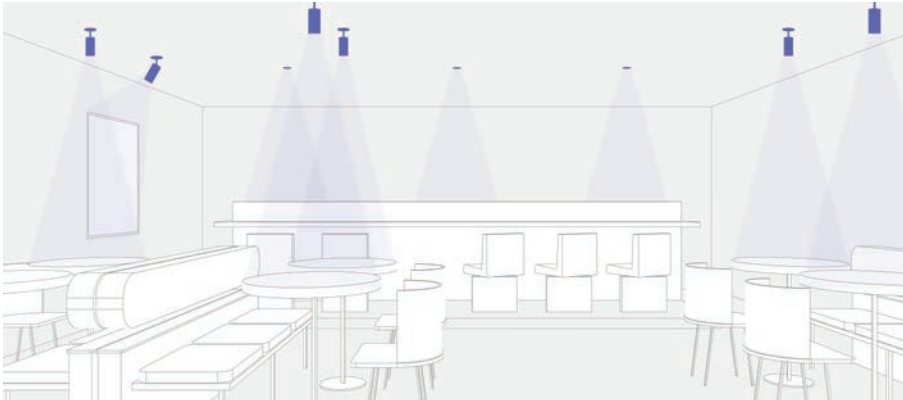

Restaurant

Beam Angle



12°



20°

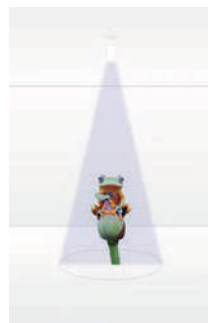

36°

FOST RECESSED

incl. DIM 355° 90° 50.000hs L80 / B10 MacAdam 2&3 220-240V 50 / 60Hz 650°C

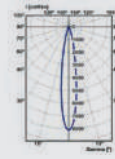
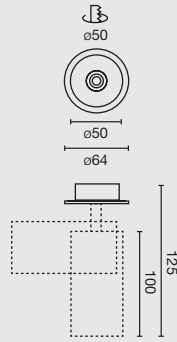

12°

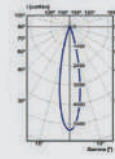

20°

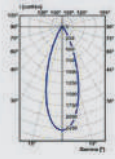

36°

Family	Color T	Beam Angle	Finish	Control System
--------	---------	------------	--------	----------------

0124 Fost Recessed 7W	927 2700K CRI90	1 12°	1 White	D ON/OFF
	930 3000K CRI90	2 20°	2 Black	
	940 4000K CRI90	3 36°		
	X27 2700K CRI97			
	X30 3000K CRI97			
	X40 4000K CRI97			

0125 Fost Recessed 15W	927 2700K CRI90	1 12°	1 White	W D ON/OFF
	930 3000K CRI90	2 20°	2 Black	
	940 4000K CRI90	3 36°		
	X27 2700K CRI97			
	X30 3000K CRI97			
	X40 4000K CRI97			

0125 927 1 1 W

Example 012592711W — Fost Recessed 15W 2700K CRI90 12° White Casambi

Option	Color T	CRI	Power	Lumen Output	Beam Angle
927	2700K	90	7W	663lm / 674lm / 699lm	12° / 20° / 36°
x27		97	7W	596lm / 607lm / 629lm	12° / 20° / 36°
930		3000K	90	7W	683lm / 695lm / 721lm
x30	97		7W	615lm / 626lm / 649lm	12° / 20° / 36°
940	4000K		90	7W	704lm / 716lm / 742lm
x40		97	7W	633lm / 644lm / 668lm	12° / 20° / 36°
927		2700K	90	15W	1235lm / 1257lm / 1303lm
X27	97		15W	1111lm / 1131lm / 1172lm	12° / 20° / 36°
930	3000K		90	15W	1273lm / 1295lm / 1343lm
X30		97	15W	1146lm / 1166lm / 1209lm	12° / 20° / 36°
940		4000K	90	15W	1311lm / 1334lm / 1383lm
X40	97		15W	1180lm / 1201lm / 1245lm	12° / 20° / 36°



F O S T

P U L L D O W N





Recessed fixture designed as a downlight, with the ability to transform into a fully functional projector thanks to its optical block extraction system. This allows it to meet the highest standards of accent lighting. This feature gives FOST PULLDOWN the flexibility required in multifunctional spaces where lighting needs to adapt or shift from a fixed position.

Luminaria empotrada diseñada para cumplir la función de downlight y con posibilidad de convertirse en un proyector 100% funcional, gracias a su sistema de extracción del bloque óptico que le permite cumplir las máximas exigencias de una iluminación de acento. Esta característica le otorga a FOST PULLDOWN una flexibilidad idónea para espacios multifuncionales, que requieran una adaptación o modificación de éste desde un punto fijo.

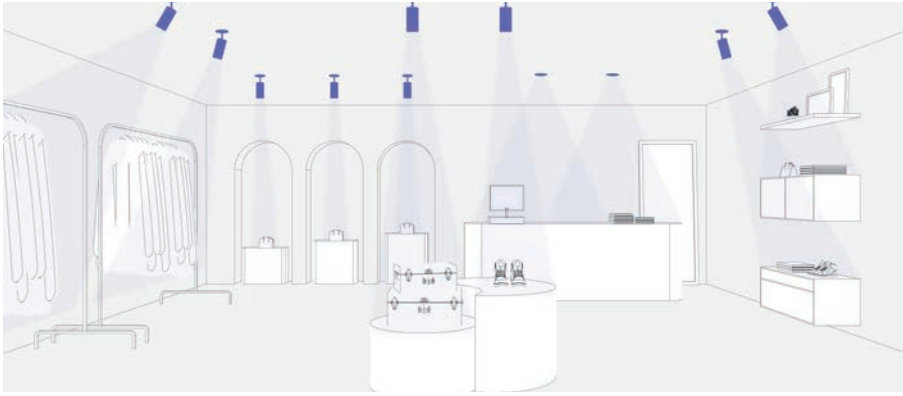

Retail

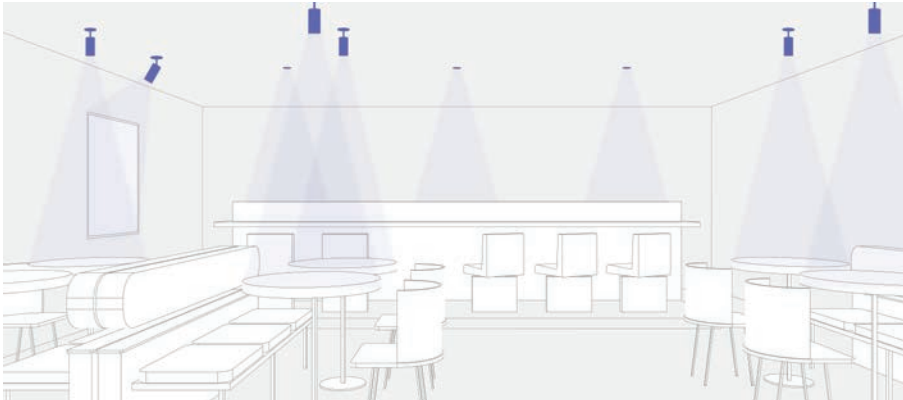

Restaurant

Beam Angle

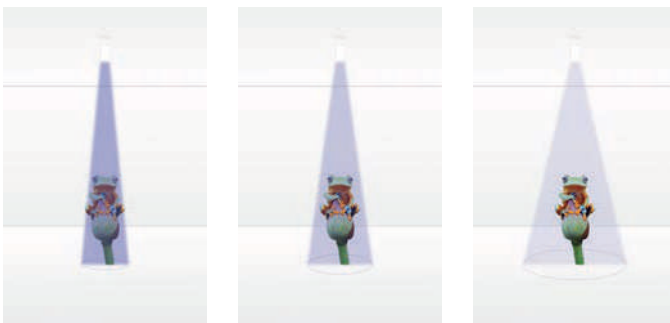

12°

20°

36°

FOST Collection



Track
41



Recessed
223



Surface
333



Ceiling
343



Suspended
391

MODULE
Modulo

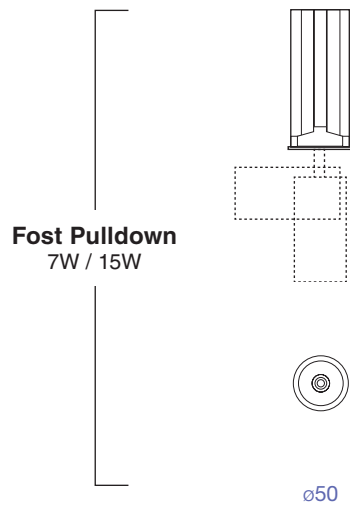

FINISH
Acabado

● **Black**
Negro

○ **White**
Blanco

COLOR TEMPERATURE
Temperatura de color

2700K CRI90	3000K CRI90	4000K CRI90
2700K CRI97	3000K CRI97	4000K CRI97

BEAM ANGLE
Ángulo de apertura



ACCESSORIES
Accesorios

○
White Ring

○
Copper Ring

CONTROL SYSTEM
Sistema de control



CASAMBI

Highlights

Its extraction system enables the block to be positioned at different heights without limiting creativity, creating a decorative geometric effect while lighting the space.

Su sistema de extracción permite posicionar el bloque a diferentes alturas sin límites para la creatividad y generando un efecto geométrico decorativo a la vez que ilumina el espacio.

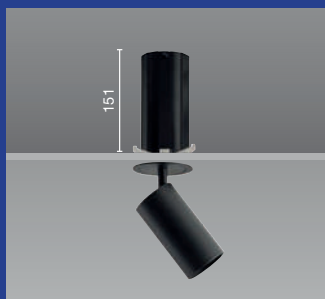

Consider the Installation Height in Your Project

Tenga en cuenta la altura de la instalación en su proyecto



High CRI Alto IRC



Several Color Temperatures Varias Temperaturas de Color

Accessories



White Ring Anillo Blanco



Copper Ring Anillo Cobre

	White Ring	Copper Ring
∅50	011600099	011600098



FOST PULLDOWN

incl. DIM 355° 90° 50.000hs L80 / B10 MacAdam 2&3 220-240V 50 / 60Hz 650°C

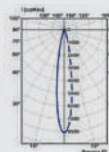
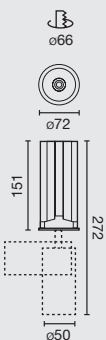

12°

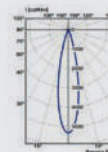

20°

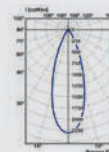

36°

Family	Color T	Beam Angle	Finish	Control System
--------	---------	------------	--------	----------------

0123 Fost Pulldown 7W	927 2700K CRI90	1 12°	1 White	D ON/OFF
	930 3000K CRI90	2 20°	2 Black	
	940 4000K CRI90	3 36°		
	X27 2700K CRI97			
	X30 3000K CRI97			
	X40 4000K CRI97			

0122 Fost Pulldown 15W	927 2700K CRI90	1 12°	1 White	W ON/OFF
	930 3000K CRI90	2 20°	2 Black	D ON/OFF
	940 4000K CRI90	3 36°		
	X27 2700K CRI97			
	X30 3000K CRI97			
	X40 4000K CRI97			

0122 927 1 1 W

Example **012292711W** — Fost Pulldown 15W 2700K CRI90 12° White Casambi

Option	Color T	CRI	Power	Lumen Output	Beam Angle
927	2700K	90	7W	663lm / 674lm / 699lm	15° / 20° / 36°
x24		97	7W	596lm / 607lm / 629lm	15° / 20° / 36°
930		3000K	90	7W	683lm / 695lm / 721lm
x30	97		7W	615lm / 626lm / 649lm	15° / 20° / 36°
940	4000K		90	7W	704lm / 716lm / 742lm
x40		97	7W	633lm / 644lm / 668lm	15° / 20° / 36°
927		2700K	90	15W	1235lm / 1257lm / 1303lm
X24	97		15W	1111lm / 1131lm / 1172lm	15° / 20° / 36°
930	3000K		90	15W	1273lm / 1295lm / 1343lm
X30		97	15W	1146lm / 1166lm / 1209lm	15° / 20° / 36°
940		4000K	90	15W	1311lm / 1334lm / 1383lm
X40	97		15W	1180lm / 1201lm / 1245lm	15° / 20° / 36°





TEIDE

TEIDE is a modular system of recessed light fixtures which stands out for its great versatility, high visual comfort and the orientability of its modules. Minimalist in design, it offers a broad integration with architecture, ideal for residential and retail use. Committed to lighting excellence with CRI97 and 2 MacAdam options.

TEIDE es un sistema modular de luminarias de empotrar que destaca por su gran versatilidad, alto confort visual y la orientabilidad de sus módulos. De diseño minimalista, ofrece una amplia integración con la arquitectura, ideal para uso residencial y retail. Apuesta por la excelencia lumínica con las opciones IRC97 y 2 MacAdam.



MODULE
Modulo

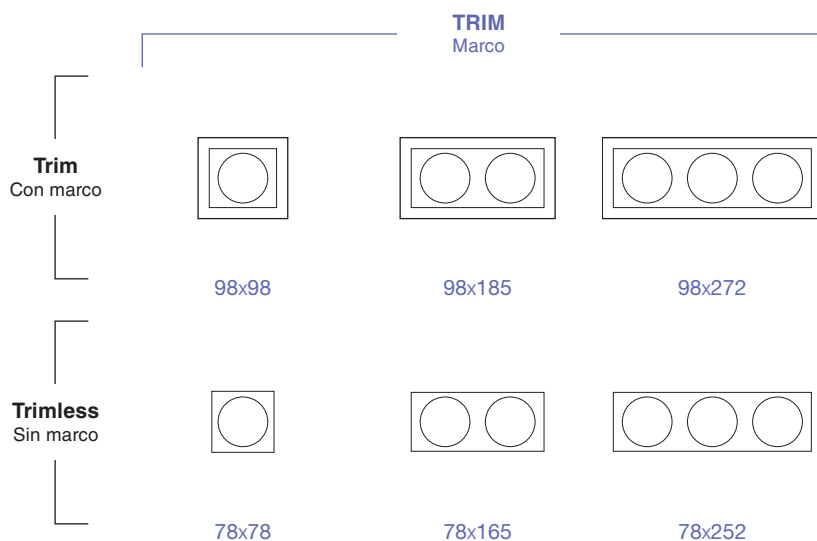
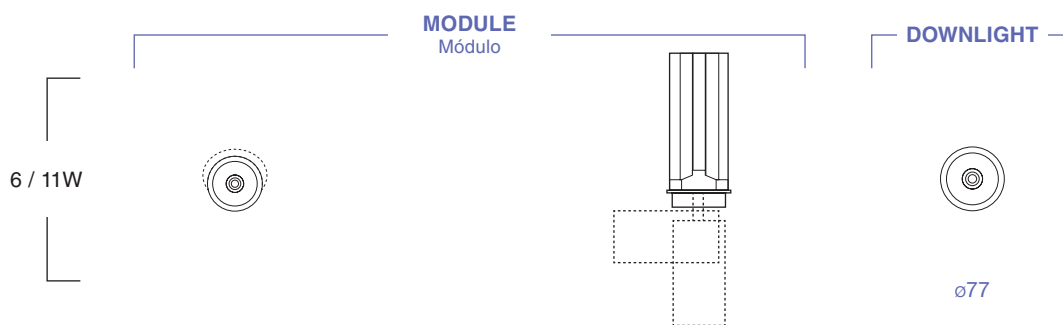

FINISH
Acabado

- **Black**
Negro
- **White**
Blanco

COLOR TEMPERATURE
Temperatura de color

2700K CRI90	3000K CRI90
2700K CRI97	3000K CRI97

BEAM ANGLE
Ángulo de apertura

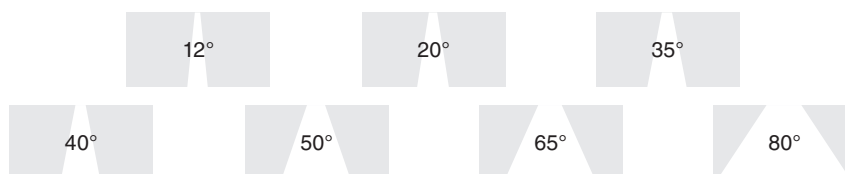

CONTROL SYSTEM
Sistema de control



Highlights

Teide System



Module Downlight



Projector



Trim 1L



Trim 2L



Trim 3L



Trimless 1L



Trimless 2L



Trimless 3L

The system consists of a round downlight module and a spotlight module that can be combined in square/rectangular recessed frames with 1, 2 and 3 lights (also available in trimless version). The downlight module is also available in a round hole installation version, TEIDE Downlight.

El sistema se compone de un módulo redondo tipo downlight y de otro tipo proyector que se pueden combinar entre sí en marcos de empotrar cuadrados/rectangulares de 1, 2 y 3 luces (también disponibles en versión sin marco). El módulo tipo downlight está además disponible en su versión de instalación para agujero redondo, TEIDE Downlight.



Pulldown Projector Module
Módulo Proyector Extraíble

Teide Downlight



Orientation without light loss
Orientación sin pérdida de luz



Trim 1L



Trim 2L

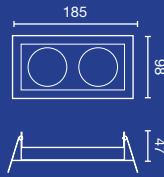

Trim 3L

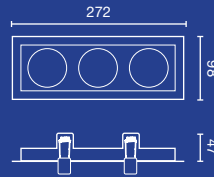

Trimless 1L

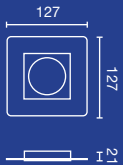

Trimless 2L

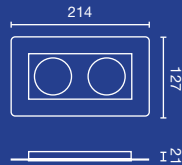

Trimless 3L

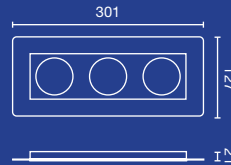

Trim Options

	Trim 1L	Trim 2L	Trim 3L	Trimless 1L	Trimless 2L	Trimless 3L
●	034600011	034600021	034600031	034700011	034700021	034700031
●	034600012	034600022	034600032	034700012	034700022	034700032

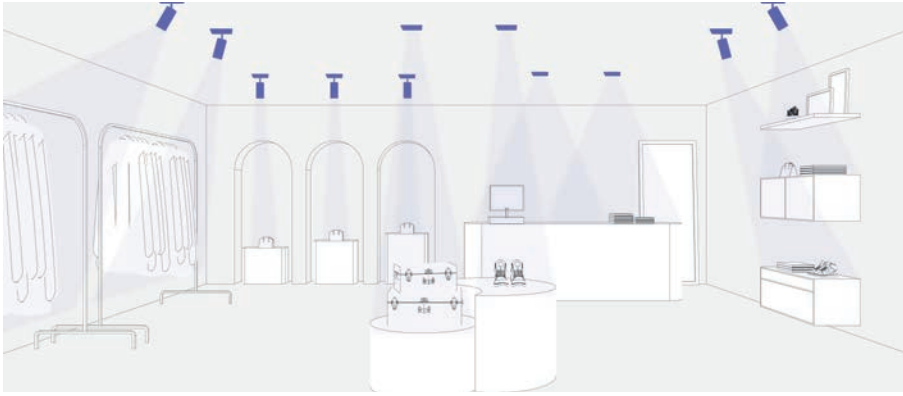

Retail



Restaurant



Residential

Downlight Beam Angle

Projector Beam Angle

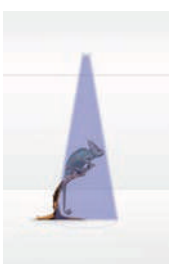

40°

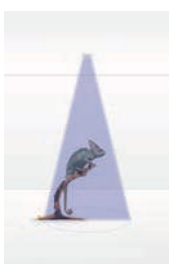

50°

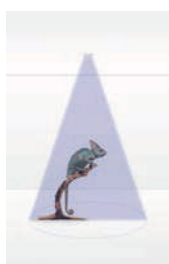

65°

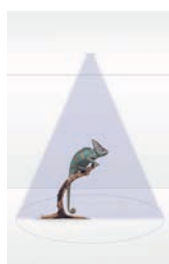

80°

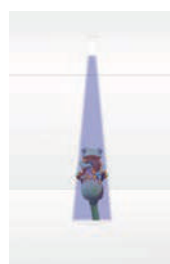

12°

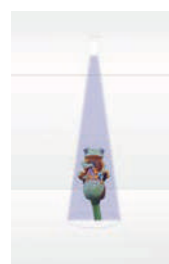

20°

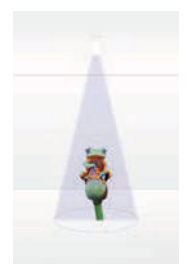

35°

TEIDE PROJECTOR MODULE

incl. DIM 355° 80° 50.000hs L70 / B10 MacAdam 2&3 220-240V 50 / 60Hz 650°C

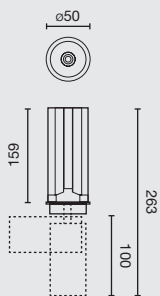

Family	Color T	Beam Angle	Finish	Control System
0349 Teide Projector Module 9W	927 2700K CRI90	1 12°	1 White	D ON/OFF
	930 3000K CRI90	2 20°	2 Black	
	X27 2700K CRI97	3 35°		
	X30 3000K CRI97			

0349 927 1 1 D

Example 034992711D — Teide Projector Module 9W 2700K CRI90 12° White Dali

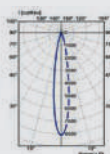

12°

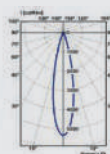

20°

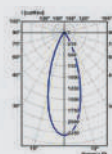

35°

Option	Color T	CRI	Power	Lumen Output	Beam Angle
927	2700K	90	9W	741lm / 754lm / 782lm	12° / 20° / 35°
X27		97	9W	667lm / 678lm / 703lm	12° / 20° / 35°
930	3000K	90	9W	764lm / 777lm / 806lm	12° / 20° / 35°
X30		97	9W	687lm / 699lm / 725lm	12° / 20° / 35°

See trim options on page 244.
Ver opciones de marco en página 244.



TEIDE DOWNLIGHT MODULE

incl. DIM 355° 45° 50.000hs L70 / B10 MacAdam 2&3 220-240V 50 / 60Hz 650°C

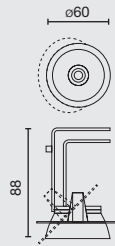

Family	Color T	Beam Angle	Finish	Control System
0352 Teide Downlight Module 10W	927 2700K CRI90	4 40°	1 White	D  ON/OFF
	930 3000K CRI90	5 50°	2 Black	
	X27 2700K CRI97	6 65°		
	X30 3000K CRI97	8 80°		

0352 927 4 1 D

Example 035292711D — Teide Projector Module 10W 2700K CRI90 40° White Dali

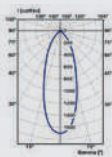

40°



50°



65°

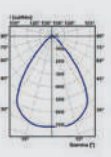

80°

Option	Color T	CRI	Power	Lumen Output	Beam Angle
927	2700K	90	10W	774lm / 769lm / 783lm / 812lm	40° / 50° / 65° / 80°
X27		97	10W	697lm / 692lm / 704lm / 731lm	40° / 50° / 65° / 80°
930	3000K	90	10W	798lm / 793lm / 807lm / 837lm	40° / 50° / 65° / 80°
X30		97	10W	718lm / 714lm / 726lm / 753lm	40° / 50° / 65° / 80°

See trim options on page 244.
Ver opciones de marco en página 244.

TEIDE DOWNLIGHT

incl. DIM 355° 45° 50.000hs L70 / B10 MacAdam 2&3 220-240V 50 / 60Hz 650°C

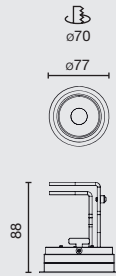

Family	Color T	Beam Angle	Finish	Control System
0348 Teide Downlight 10W	927 2700K CRI90	4 40°	1 White	D  ON/OFF
	930 3000K CRI90	5 50°	2 Black	
	X27 2700K CRI97	6 65°		
	X30 3000K CRI97	8 80°		

0348 927 4 1 D

Example **034892741D** — Teide Projector Module 10W 2700K CRI90 40° White Dali

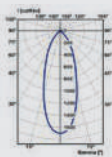

40°



50°

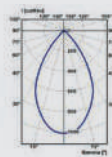

65°

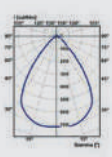

80°

Option	Color T	CRI	Power	Lumen Output	Beam Angle
927	2700K	90	10W	774lm / 769lm / 783lm / 812lm	40° / 50° / 65° / 80°
X27		97	10W	697lm / 692lm / 704lm / 731lm	40° / 50° / 65° / 80°
930	3000K	90	10W	798lm / 793lm / 807lm / 837lm	40° / 50° / 65° / 80°
X30		97	10W	718lm / 714lm / 726lm / 753lm	40° / 50° / 65° / 80°

See trim options on page 244.
Ver opciones de marco en página 244.



PODIUM is a modular system of recessed and surface light fixtures which offers different light effects and configurations, enabling the creation of different climates with an integrated aesthetic. One product, one project, infinite possibilities.

PODIUM es un sistema modular de luminarias de empotrar y de superficie que ofrece diferentes efectos lumínicos y configuraciones permitiendo generar diversos climas con una estética integrada. Un producto, un proyecto, infinitas posibilidades.

PODIUM



PODIUM Collection



Surface
353

MODULE
Modulo

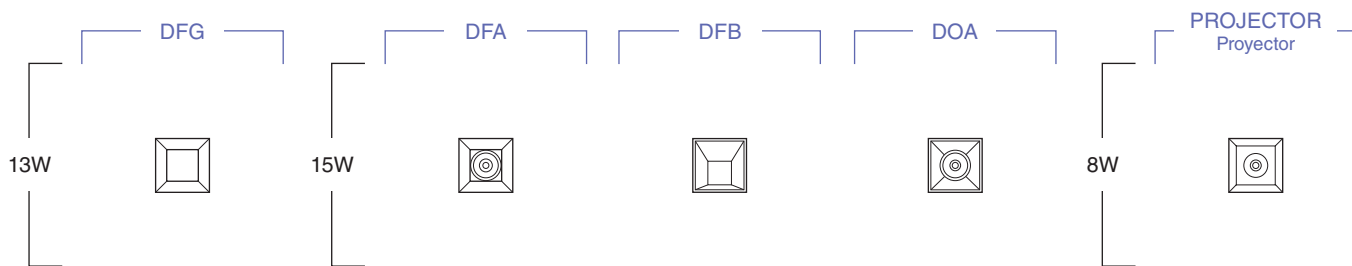

TRIM
Marco



FINISH
Acabado



COLOR TEMPERATURE
Temperatura de color



BEAM ANGLE
Ángulo de apertura

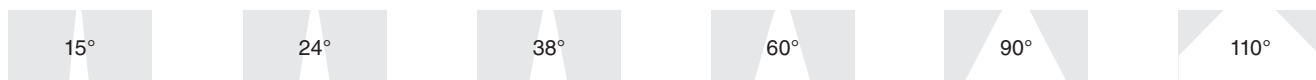

ACCESSORIES
Accesorios



CONTROL SYSTEM
Sistema de control



Highlights

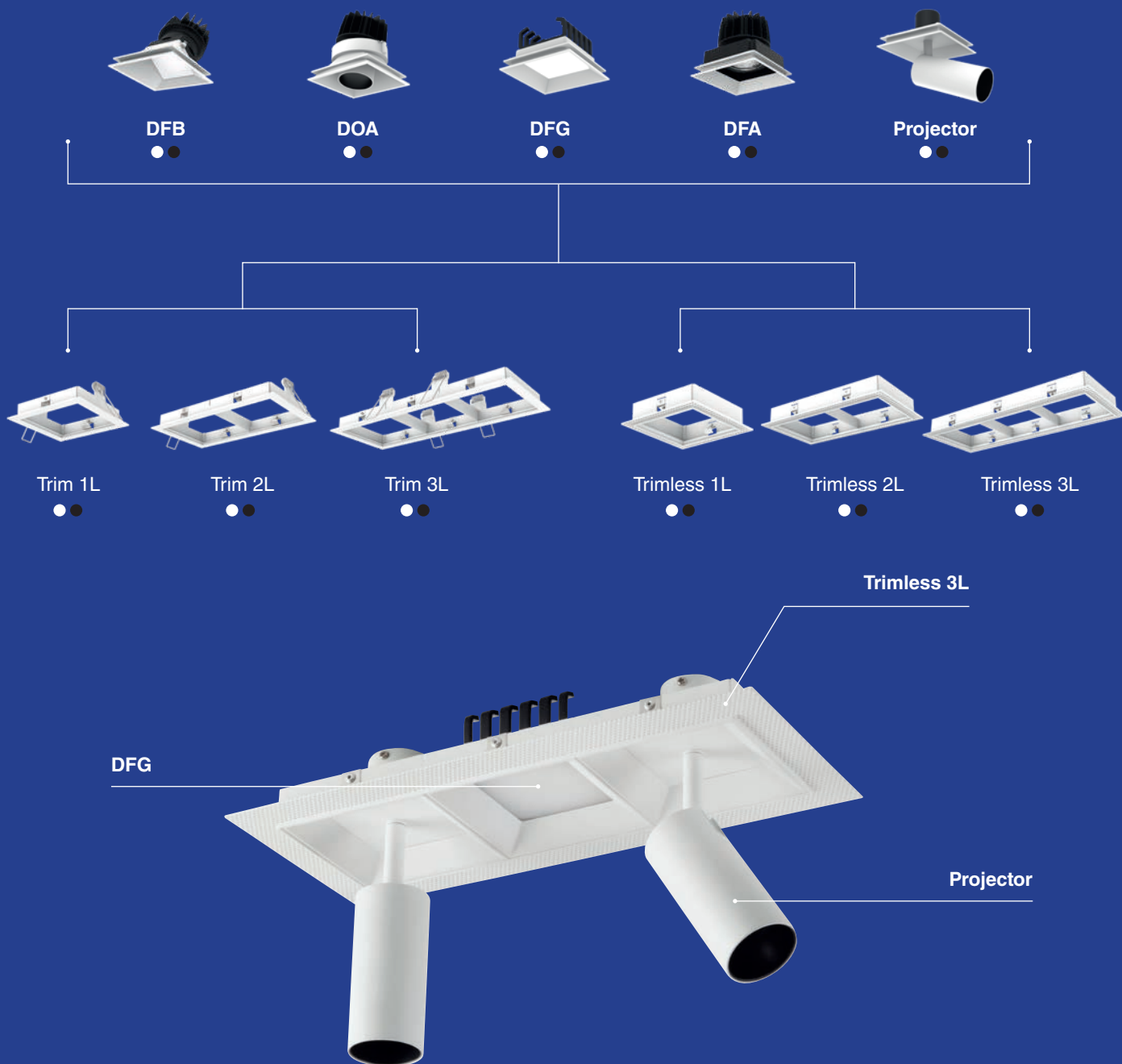

The recessed system has options with or without a trim of 1, 2 and 3 lights, making it possible to combine general, downlight, fixed and orientable accent and projector lighting optics into one product. The family is offered in 3 color temperatures and high CRI.

El sistema empotrable cuenta con opciones con y sin marco de 1,2 y 3 luces pudiendo combinar en un mismo producto ópticas de iluminación general, bañador, acento fija y orientable y proyector. La familia se ofrece en 3 temperaturas de color y alto IRC.

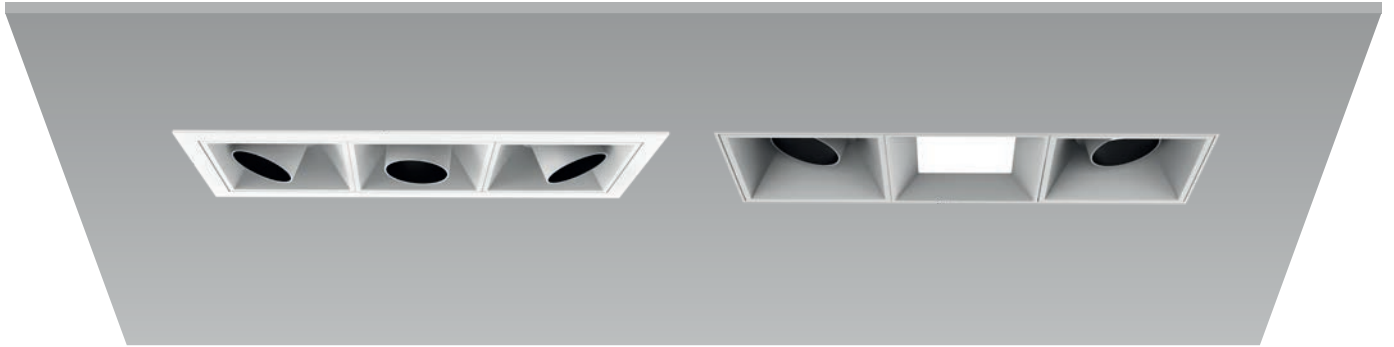



103x103

Trim 1L

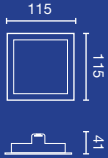

103x194

Trim 2L

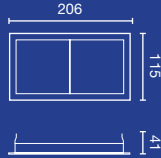

103x285

Trim 3L

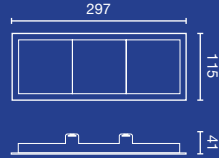

98x98

Trimless 1L

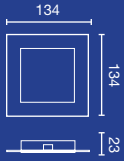

98x189

Trimless 2L

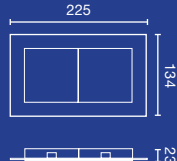

98x279

Trimless 3L

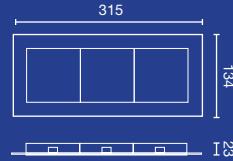

Honeycomb
Panel de abeja



Stripped Glass
Vidrio estriado



Diffusion Sheet
Lámina difusora

Trim Options

Accessories for DFA&DOA

Trim 1L	Trim 2L	Trim 3L	Trimless 1L	Trimless 2L	Trimless 3L	Honeycomb	Stripped Glass	Diffusion Sheet
● 034100011	034100021	034100031	034200011	034200021	034200031	034100098	034100097	034100099
● 034100012	034100022	034100032	034200012	034200022	034200032			



Residential



Restaurant

Beam Angle



15°



24°



38°

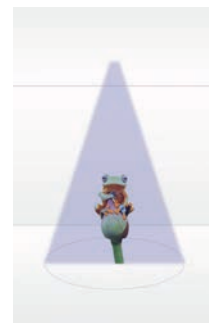

60°

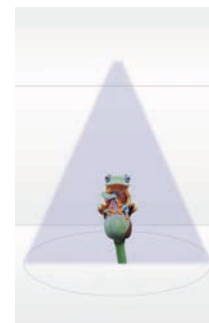

90°

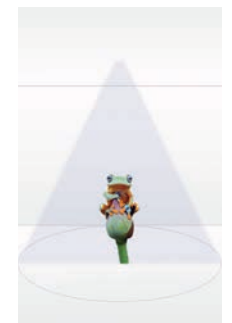

110°

PODIUM DFA MODULE

incl. DIM 50.000hs L70 / B10 MacAdam 3 220-240V 50 / 60Hz 650°C



Family	Color T	Beam Angle	Finish	Control System
0341 Podium DFA Module 15W	927 2700K CRI97	1 15°	1 White	W CASAMBI
	930 3000K CRI97	2 24°	2 Black	D DALI
	940 4000K CRI97	3 38°		C TRIAC
		6 60°		ON/OFF

0341 927 1 1 W

Example 034192711W — Podium DFA 15W 2700K CRI97 15° White Casambi

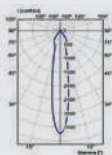

15°

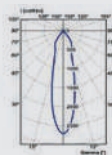

24°

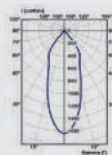

38°

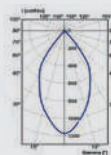

60°

Option	Color T	CRI	Power	Lumen Output	Beam Angle
X27	2700K	97	15W	1121lm / 1026lm / 1036lm / 1060lm	15° / 24° / 38° / 60°
X30	3000K	97	15W	1156lm / 1058lm / 1068lm / 1093lm	15° / 24° / 38° / 60°
X40	4000K	97	15W	1191lm / 1090lm / 1100lm / 1126lm	15° / 24° / 38° / 60°

PODIUM DOA MODULE

incl. DIM 355° 20° 50.000hs L70 / B10 MacAdam 3 220-240V 50 / 60Hz 650°C

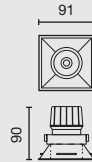

Family	Color T	Beam Angle	Finish	Control System
0342 Podium DOA Module 15W	927 2700K CRI97	1 15°	1 White	W CASAMBI
	930 3000K CRI97	2 24°	2 Black	D DALI
	940 4000K CRI97	3 38°		C TRIAC
		6 60°		ON/OFF

0342 927 1 1 W

Example 034292711W — Podium DOA 15W 2700K CRI97 15° White Casambi

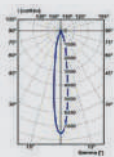

15°

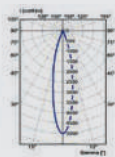

24°

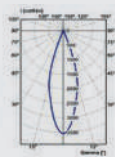

38°

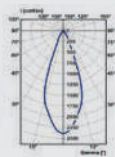

60°

Option	Color T	CRI	Power	Lumen Output	Beam Angle
X27	2700K	97	15W	435lm / 439lm / 448lm / 456lm	15° / 24° / 38° / 60°
X30	3000K	97	15W	448lm / 453lm / 462lm / 470lm	15° / 24° / 38° / 60°
X40	4000K	97	15W	461lm / 467lm / 476lm / 484lm	15° / 24° / 38° / 60°

PODIUM DFB MODULE

incl. DIM 50.000hs L70 / B10 MacAdam 3 220-240V 50 / 60Hz 650°C



Family	Color T	Beam Angle	Finish	Control System								
0344 Podium DFB Module 15W	927 2700K CRI97	9 90°	1 White	<table border="1"> <tr><td>W</td><td>CASAMBI</td></tr> <tr><td>D</td><td>DALI</td></tr> <tr><td>C</td><td>TRIAC</td></tr> <tr><td></td><td>ON/OFF</td></tr> </table>	W	CASAMBI	D	DALI	C	TRIAC		ON/OFF
	W		CASAMBI									
	D		DALI									
C	TRIAC											
	ON/OFF											
930 3000K CRI97	2 Black											
940 4000K CRI97												

0344 927 1 1 W

Example **034492711W** — Podium DFB 15W 2700K CRI97 90° White Casambi

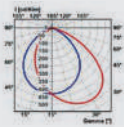

90°

Option	Color T	CRI	Power	Lumen Output	Beam Angle
X27	2700K	97	15W	228lm	90°
X30	3000K	97	15W	235lm	90°
X40	4000K	97	15W	242lm	90°



PODIUM PROJECTOR MODULE

incl. DIM 355° 90° 50.000hs L80 / B10 MacAdam 3 220-240V 50 / 60Hz 650°C

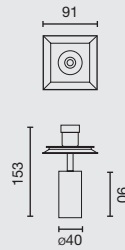

Family	Color T	Beam Angle	Finish	Control System
0345 Podium Projector Module 8W	927 2700K CRI97	1 15°	1 White	W CASAMBI
	930 3000K CRI97	2 25°	2 Black	D BALI
	940 4000K CRI97			C TRIAC ON/OFF

0341 927 1 1 W

Example 034192711W — Podium DFA 15W 2700K CRI97 15° White Casambi

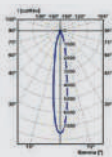

15°

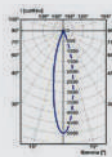

25°

Option	Color T	CRI	Power	Lumen Output	Beam Angle
X27	2700K	97	8W	273lm / 273lm	15° / 25°
X30	3000K	97	8W	281lm / 281lm	15° / 25°
X40	4000K	97	8W	289lm / 289lm	15° / 25°

PODIUM DFG MODULE

incl. DIM 50.000hs L70 / B10 MacAdam 3 220-240V 50 / 60Hz 650°C



Family	Color T	Beam Angle	Finish	Control System								
0343 Podium DFG Module 13W	927 2700K CRI90	0 110°	1 White	<table border="1"> <tr> <td>W</td> <td>CASAMBI</td> </tr> <tr> <td>D</td> <td>BALI</td> </tr> <tr> <td>C</td> <td>TRIAC</td> </tr> <tr> <td></td> <td>ON/OFF</td> </tr> </table>	W	CASAMBI	D	BALI	C	TRIAC		ON/OFF
	W		CASAMBI									
	D		BALI									
C	TRIAC											
	ON/OFF											
930 3000K CRI90	2 Black											
940 4000K CRI90												

0343 927 1 1 W

Example **034392711W** — Podium DFG 13W 2700K CRI90 110° White Casambi

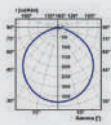

110°

Option	Color T	CRI	Power	Lumen Output	Beam Angle
927	2700K	90	13W	648lm	110°
930	3000K	90	13W	668lm	110°
940	4000K	90	13W	688lm	110°

The BACKLIGHT panels are the perfect choice for efficiency and illuminating offices in an elegant way. These recessed panels provide soft and uniform lighting that promotes a comfortable and productive environment. Their discreet design easily integrates into the aesthetics of any office space. The uniform lighting they offer helps reduce glare and improve visual quality in the workplace.

Los paneles BACKLIGHT son la elección perfecta para iluminar oficinas de manera eficiente y elegante. Estos paneles empotrables proporcionan una iluminación suave y uniforme que favorece un ambiente cómodo y productivo. Su diseño discreto se integra fácilmente en la estética de cualquier espacio de oficina. La iluminación uniforme que ofrece contribuye a reducir el deslumbramiento y a mejorar la calidad visual en el lugar de trabajo.



BACK LIGHT



Office

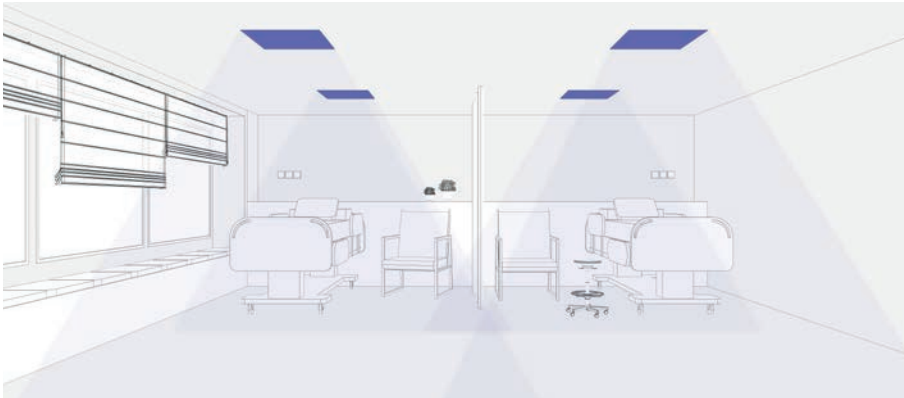

Hospital

Beam Angle



90°

MODULE
Modulo

Backlight
1195x295mm
36W



Backlight
595mm
36W



FINISH
Acabado

White
Blanco

COLOR TEMPERATURE
Temperatura de color

3000K CRI80

4000K CRI80

BEAM ANGLE
Ángulo de apertura



CONTROL SYSTEM
Sistema de control



Highlights

Thanks to its easy installation and high energy efficiency, this panel becomes the ideal option for providing general lighting in large spaces. With a UGR glare index below 19, it is a perfect choice for office environments.

Gracias a su sencilla instalación y su alta eficiencia energética, este panel se convierte en la opción ideal para proveer iluminación general en espacios amplios. Con un índice de deslumbramiento UGR inferior a 19, resulta una elección perfecta para entornos de oficina.



High Efficiency
Alta eficiencia



Easy Installation Modular Ceiling
Techo modular de fácil instalación

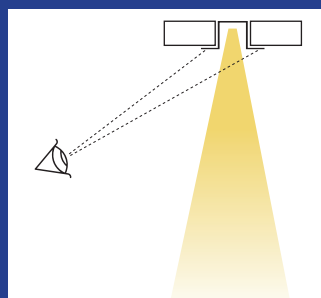

UGR<19
IDU<19

BACKLIGHT 36W

incl. DIM 50.000hs L90 / B10 MacAdam 3 220- 50/ 240V 60Hz 650°C UGR <19

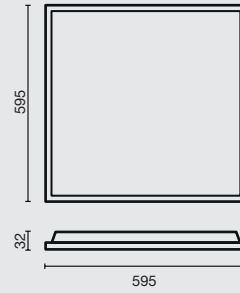
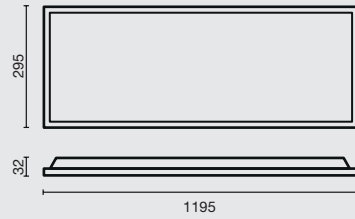

Family	Color T	Beam Angle	Finish	Control System
0363 Backlight 1195x295 36W	830 3000K CRI80	9 90°	1 White	W CASAMBI
0364 Backlight 595x595 36W	840 4000K CRI80			D DALI
				ON/OFF

0363 **830** **9** **1** **D**

Example **036383091D** — Backlight 1195x295 36W 3000K CRI80 90° White Dali

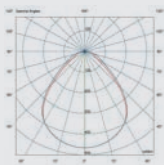

90°

Option	Color T	CRI	Power	Lumen Output	Beam Angle
830	3000K	80	36W	4499lm	90°
840	4000K	80	36W	4638lm	90°

S U R

F A C E

Our TAK surface luminaire delivers comfortable diffuse lighting across any space, creating an ideal environment where visual precision and comfort are essential. Its high luminous efficiency and neutral geometry ensure seamless integration in various settings, enhancing overall spatial perception.

Nuestra luminaria TAK superficie ofrece luz difusa confortable sobre cualquier estancia, generando un ambiente ideal en espacios donde la precisión visual y el confort son prioritarios. Esta luminaria de superficie ofrece una gran eficiencia lumínica, ideal para cualquier estancia gracias a su geometría neutral, contribuyendo a una adecuada percepción espacial.



TAK

NEW



S U R F A C E



TAK Collection



Suspended

367

MODULE
Modulo

TAK
Surface

20W

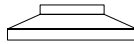

FINISH
Acabado

● **Black**
Negro

○ **White**
Blanco

COLOR TEMPERATURE
Temperatura de color

2700K CRI90

3000K CRI90

4000K CRI90

BEAM ANGLE
Ángulo de apertura

90°

CONTROL SYSTEM
Sistema de control



CASAMBI



Highlights



High CRI
Alto IRC

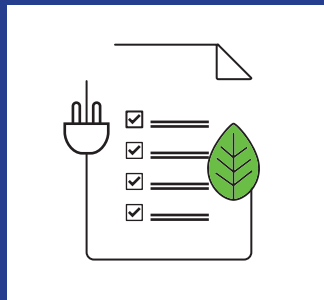

High Efficiency
Alta eficiencia

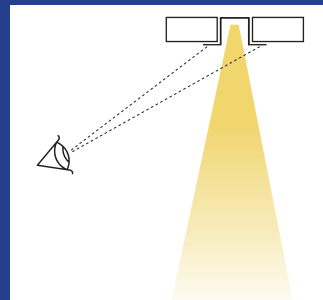

UGR<19



Microprsim
Microprisma



Compatible with FARO fans*
Compatible con ventiladores FARO

*Check out the FAN catalogue.
Echa un vistazo al catálogo FAN.



Office



Hospital

Beam Angle

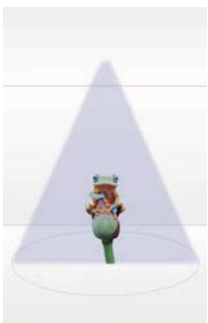

90°

TAK SURFACE



incl. DIM 50.000hs L70 / B10 MacAdam 3 110-277V 650°C UGR <19

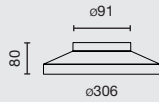

Family	Color T	Diffuser	Finish	Control System
0430 Tak Surface 20W	927 2700K CRI90	1 Microprism	1 White	W CASAMBI D BALI C TRIAC ON/OFF
	930 3000K CRI90		2 Black	
	940 4000K CRI90			

0430 927 1 2 W

Example **043092712W** — Tak Surface 20W 2700K CRI90 Microprism Black Casambi

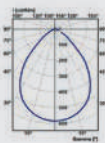

90°

Option	Color T	CRI	Power	Lumen Output	Beam Angle
927	2700K	90	20W	1940lm	90°
930	3000K	90	20W	2000lm	90°
940	4000K	90	20W	2060lm	90°



Our TEK surface luminaire delivers accent lighting with excellent color rendering over a defined zone, ideal for guiding pathways or distinguishing areas with calm, functional illumination. Its neutral geometry ensures natural integration in any environment, contributing to clear and balanced spatial perception.

Nuestra luminaria TEK superficie ofrece luz de acento con fidelidad cromática sobre una zona específica, útil para acompañar recorridos o diferenciar zonas con una iluminación serena y funcional. Esta luminaria de superficie ofrece una integración natural en cualquier espacio gracias a su geometría neutral, contribuyendo a una adecuada percepción espacial.



TEK

NEW



S U R F A C E

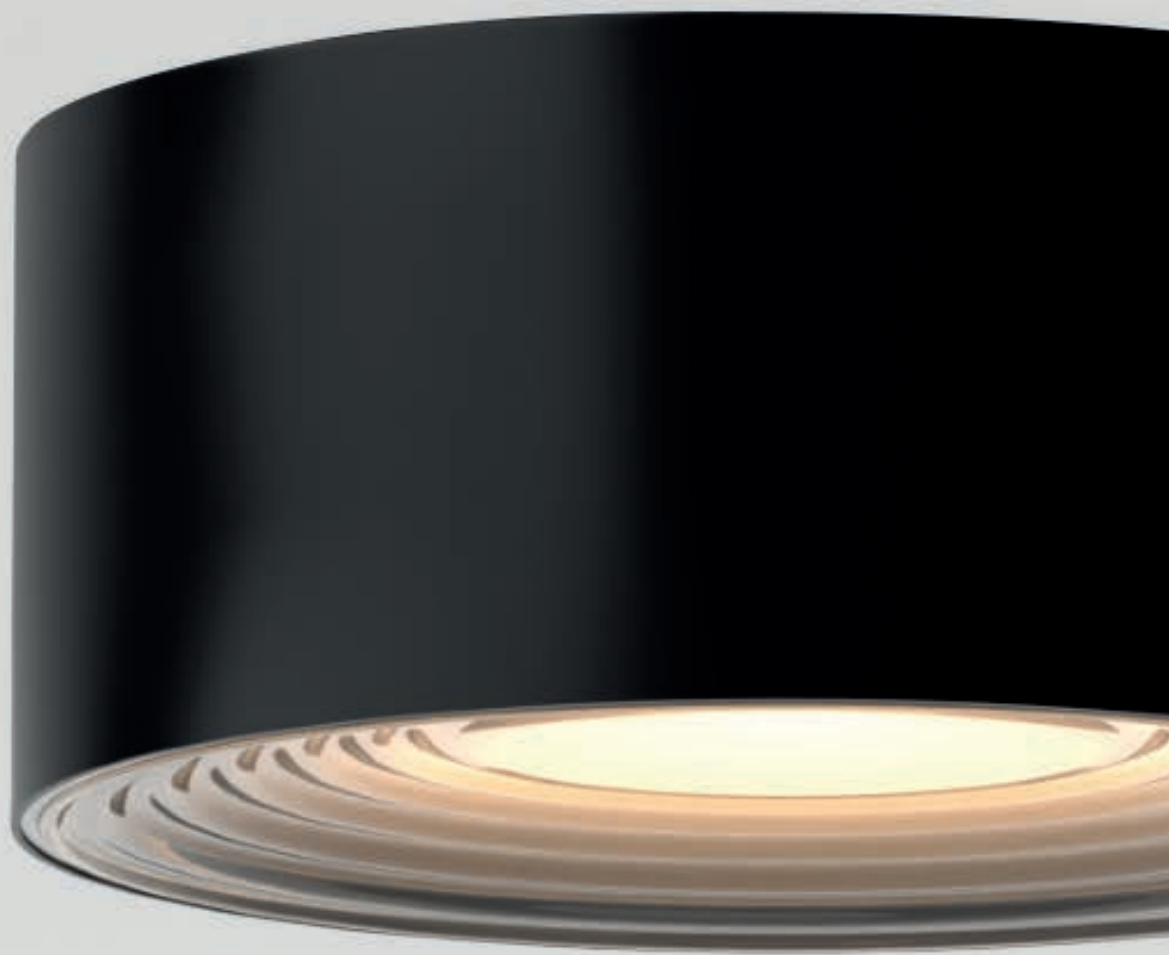

TEK Collection



Suspended
375

MODULE
Modulo

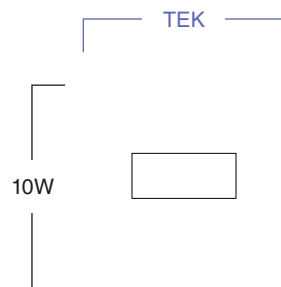

FINISH
Acabado

● **Black**
Negro

○ **White**
Blanco

COLOR TEMPERATURE
Temperatura de color

2700K CRI90

3000K CRI90

4000K CRI90

BEAM ANGLE
Ángulo de apertura



CONTROL SYSTEM
Sistema de control



Highlights

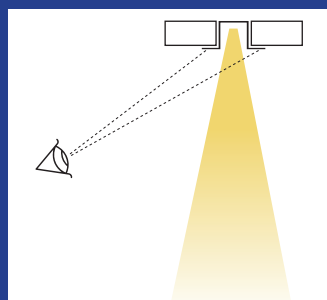

UGR<16



Several color temperatures
Varias temperaturas de color



Compatible with FARO fans*
Compatible con ventiladores FARO

*Check out the FAN catalogue.
Echa un vistazo al catálogo FAN.



Residential



Restaurant

Beam Angle



40°

TEK SURFACE

NEW

incl. DIM 50.000hs L70 / B10 MacAdam 3 220-240V 650°C UGR <16

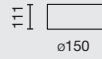

Family	Color T	Beam Angle	Finish	Control System
0432 Tek Surface 10W	927 2700K CRI90	4 40°	1 White	C
	930 3000K CRI90		2 Black	
	940 4000K CRI90			

0432 927 4 2 C

Example **043292742C** — Tek Surface 10W 2700K CRI90 40° Black Triac

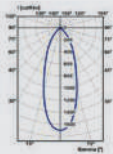

40°

Option	Color T	CRI	Power	Lumen Output	Beam Angle
927	2700K	90	10W	750	40°
930	3000K	90	10W	774	40°
940	4000K	90	10W	798	40°





DOMIO







DOMIO is a family of circular light fixtures with pure lines. Its different sizes and installation options make it an ideal solution for the lighting of big spaces like lobbies, conference rooms and restaurants. Its glare control options and Tunable White(TW) make it a perfect option for work zones and spaces dedicated to healthcare.

DOMIO es una familia de luminarias circulares de líneas puras. Sus diferentes tamaños y opciones de instalación la convierten en una solución ideal para la iluminación de grandes espacios como vestíbulos, salas de conferencias y restaurantes. Sus opciones con el control del deslumbramiento y Tunable White (TW) hacen que sea una opción perfecta para zonas de trabajo y espacios dedicados a la salud.

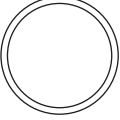
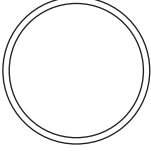

MODULE
Modulo

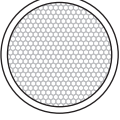
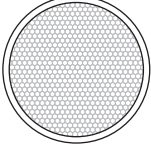
	Domio ø400 36W	Domio ø600 33/43W	Domio ø800 78W	Domio ø1000 95W
Opal				
Microprisma				

FINISH
Acabado

● **Black**
Negro

○ **White**
Blanco

COLOR TEMPERATURE
Temperatura de color

3000K

4000K

2700-6500K

ACCESSORIES
Accesorios



Suspended

CONTROL SYSTEM
Sistema de control



CASAMBI

Highlights

Available in 4 sizes of 400 mm, 600 mm, 800 mm and 1000 mm with two optics variants: opal high-transmittance PMMA to offer uniform and microprismatic general lighting for applications where glare control is required. Its UGR<19 make it an ideal option for office or continuous work applications.

Disponible en 4 tamaños de 400mm, 600mm, 800mm y 1000mm con dos variantes de ópticas: PMMA opal de alta transmitancia para ofrecer una iluminación general uniforme y micro prismática para aplicaciones donde el control de deslumbramiento es una necesidad. Su UGR<19 lo convierten en una opción ideal para aplicaciones de oficina o de trabajo en continuo.



Opal Diffuser

Microprism Diffuser

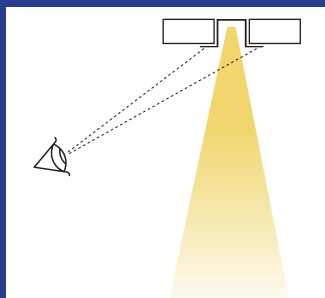

UGR<19



Different Sizes
Diversos tamaños



Tunable White



Semi-recessed Option
Opción semi empotrado



Wall & Ceiling
Aplicue y plafón



Suspended Option
Opción colgante





Suspended

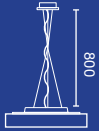

Accessories

Suspended

● 050000097

● 050000098



Office

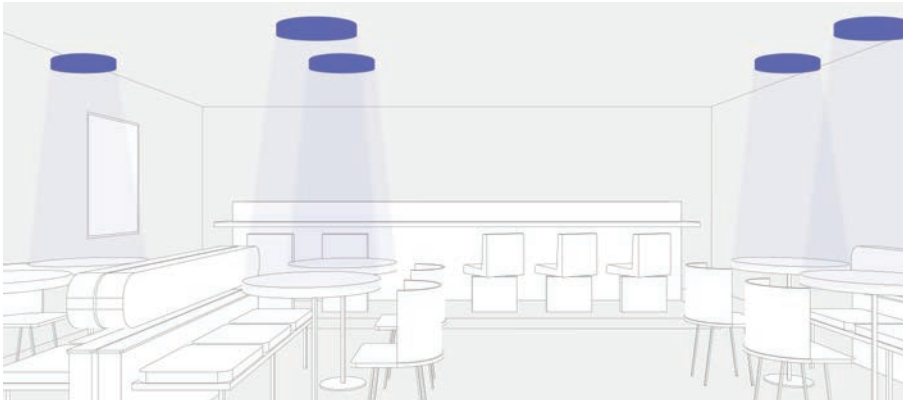

Restaurant

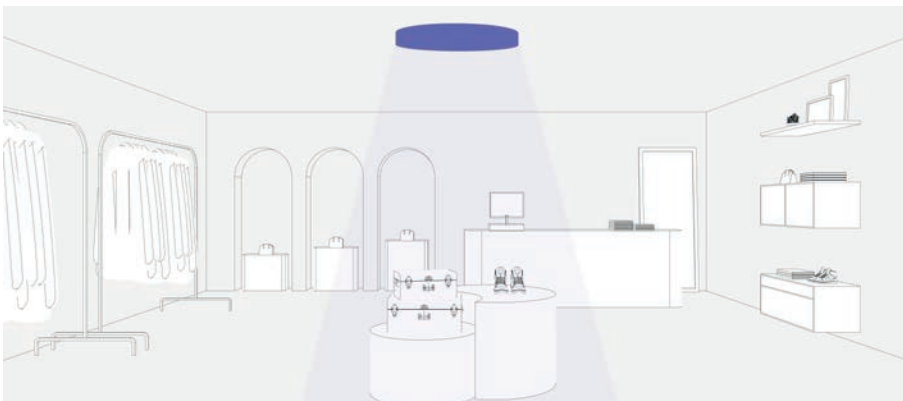

Retail

Beam Angle

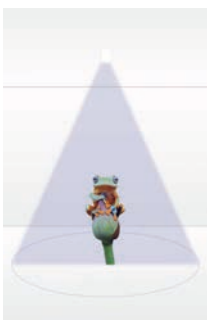

90°

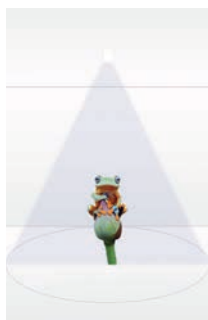

110°

DOMIO ø400 36W

incl. DIM 50.000hs L70 / B10 MacAdam 3 220-240V 50 / 60Hz 650°C UGR <19

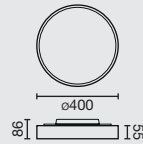

Family	Color T	Diffuser	Finish	Control System
0414 Domio ø400 36W	830 3000K CRI80	1 Opal	1 White	W CASAMBI
	840 4000K CRI80	2 Microprism	2 Black	D DALI ON/OFF

0414 830 1 1 W

Example **041483011W** — Domio ø400 36W 3000K Opal Diffuser White Casambi

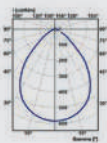

90°
microprism

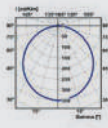

110°
opal

Option	Color T	CRI	Power	Lumen Output	Diffuser
830	3000K	80	36W	3861lm	Opal
				3047lm	Microprism
840	4000K	80	36W	3977lm	Opal
				3138lm	Microprism

DOMIO ø600 43W

incl. DIM TW 50.000hs L80 / B10 MacAdam 3 220-240V 50 / 60Hz 650°C UGR <19

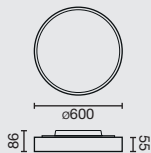

Family	Color T	Diffuser	Finish	Control System
0415 Domio ø600 43W	830 3000K CRI80	1 Opal	1 White	W CASAMBI
	840 4000K CRI80	2 Microprism	2 Black	D DALI ON/OFF
0419 Domio ø600 33W TW	TW 2700-6500K	1 Opal	1 White	W CASAMBI
		2 Microprism	2 Black	D DALI

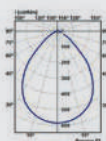

90°
microprism

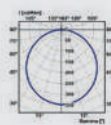

110°
opal

Option	Color T	CRI	Power	Lumen Output	Diffuser
830	3000K	80	43W	4725lm	Opal
				4059lm	Microprism
840	4000K	80	43W	4867lm	Opal
				4181lm	Microprism

DOMIO ø600 TW

TW	2700-6500K	-	33W	3528lm	Opal
TW	2700-6500K	-	33W	3031lm	Microprism

DOMIO ø800 78W

incl. DIM 50.000hs L80 / B10 MacAdam 3 220-240V 50 / 60Hz 650°C UGR <19

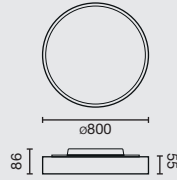

Family	Color T	Diffuser	Finish	Control System
0416 Domio ø800 78W	830 3000K CRI80	1 Opal	1 White	W CASAMBI
	840 4000K CRI80	2 Microprism	2 Black	D DALI ON/OFF

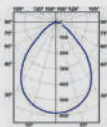

90°
microprism

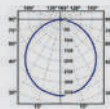

110°
opal

Option	Color T	CRI	Power	Lumen Output	Diffuser
830	3000K	80	78W	8174lm	Opal
				7022lm	Microprism
840	4000K	80	78W	8419lm	Opal
				7232lm	Microprism

DOMIO ø1000 95W

incl. DIM 50.000hs L80 / B10 MacAdam 3 220-240V 50 / 60Hz 650°C UGR <19

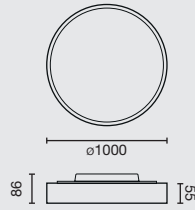

Family	Color T	Diffuser	Finish	Control System
0417 Domio ø1000 95W	830 3000K CRI80	1 Opal	1 White	W CASAMBI
	840 4000K CRI80	2 Microprism	2 Black	D DALI ON/OFF

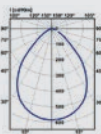

90°
microprism

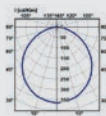

110°
opal

Option	Color T	CRI	Power	Lumen Output	Diffuser
830	3000K	80	95W	10490lm	Opal
				9010lm	Microprism
840	4000K	80	95W	10804lm	Opal
				9281lm	Microprism

The TROOP Surface provides high-precision linear lighting with glare control through its UGR optics. Ideal for surface mounting in commercial spaces and offices, it combines modular design and lighting efficiency. Its uniform and comfortable light ensures a visually pleasant environment, seamlessly integrating into any architectural style.

El modelo TROOP Surface ofrece una iluminación lineal de alta precisión, con control del deslumbramiento gracias a su óptica IDU. Ideal para superficies en espacios comerciales y oficinas, combina diseño modular y eficiencia lumínica. Su luz uniforme y confortable garantiza un ambiente visualmente agradable, integrándose perfectamente en cualquier estilo arquitectónico.



TROOP



S U R F A C E



TROOP Collection



Recessed
167

MODULE
Modulo

TRIM
Con marco

WALL WASHER
Bañador de pared

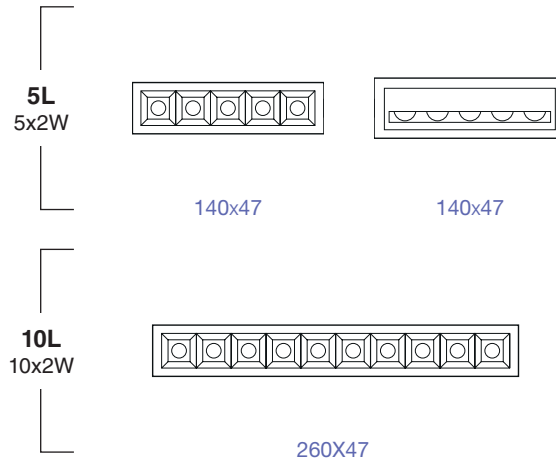

FINISH
Acabado

- **Black+Black**
Negro+Negro
- **Black+White**
Negro+Blanco
- **White+White**
Blanco+Blanco
- **White+Black**
Blanco+Negro
- **Black+Gold**
Negro+Oro
- **White+Gold**
Blanco+Oro

COLOR TEMPERATURE
Temperatura de color

- 2700K CRI90
- 3000K CRI90
- 4000K CRI90

BEAM ANGLE
Ángulo de apertura



CONTROL SYSTEM
Sistema de control



CASAMBI



Highlights

Anti-glare optics
Óptica antideslumbrate

UGR

Reflector with dark light technology
Reflector con tecnología dark light

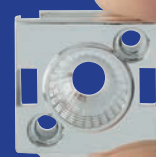
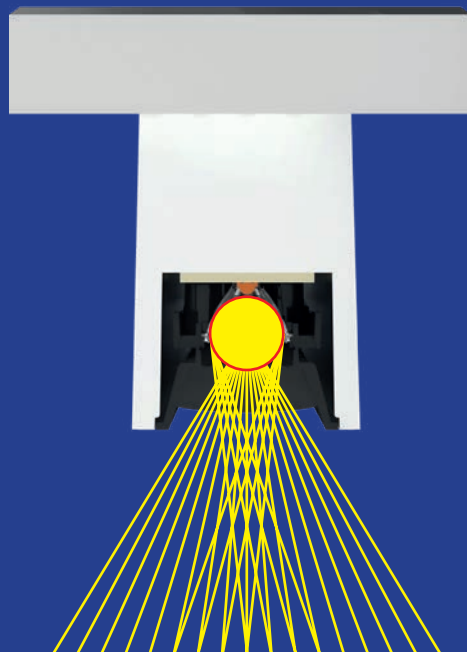

Linear design with circular light effect

Diseño lineal con efecto lumínico circular



Wall Washer Version

Versión Bañador de Pared



Several Color Temperatures

Varias Temperaturas de Color

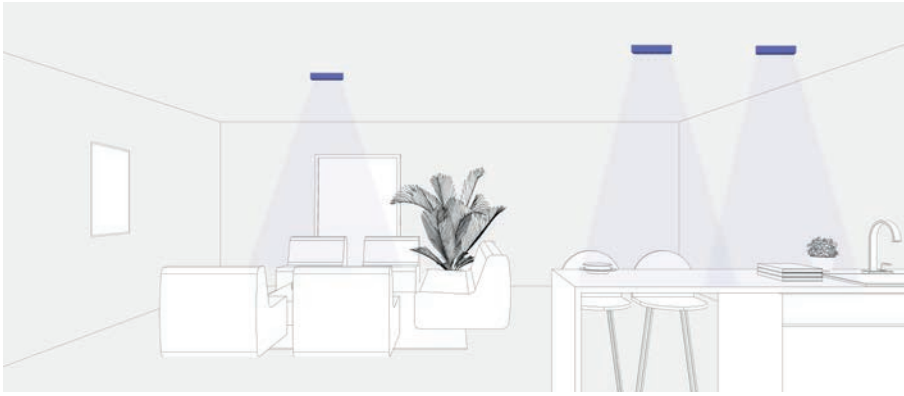

Residential

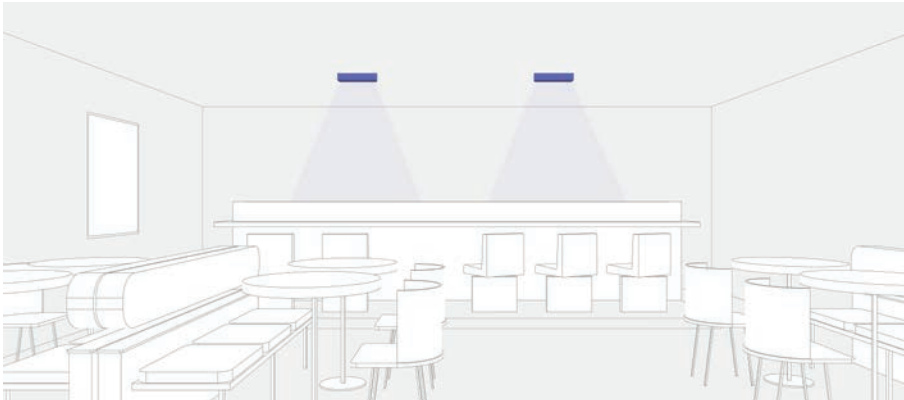

Restaurant

Beam Angle



15°

36°

48°

TROOP SURFACE 5L

incl. DIM 50.000hs L80 / B10 MacAdam 3 220-240V 650°C UGR <16

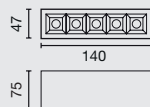
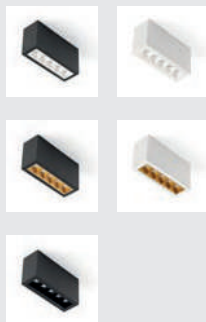

Family	Color T	Beam Angle	Finish	Anti-Glare	Control System
43708 Troop Surface 5x2W	927 2700K CRI90	1 15°	1 White	1 White	C TRIAC ON/OFF
	930 3000K CRI90	3 36°	2 Black	2 Black	
	940 4000K CRI90	4 48°		4 Gold	

43708 927 1 1 1 W

Example 43708927111 — Troop Surface 5x2W 2700K 15° White White Casambi

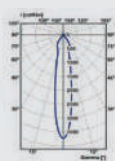

15°

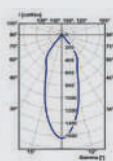

36°

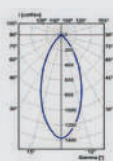

48°

Option	Color T	CRI	Power	Lumen Output	Beam Angle
927	2700K	90	5x2W	672lm / 841lm / 828lm	15° / 36° / 48°
930	3000K	90	5x2W	692lm / 866lm / 853lm	15° / 36° / 48°
940	4000K	90	5x2W	712lm / 891lm / 878lm	15° / 36° / 48°



TROOP SURFACE 10L

incl. DIM 50.000hs L80 / B10 MacAdam 3 220-240V 650°C UGR <16

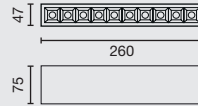
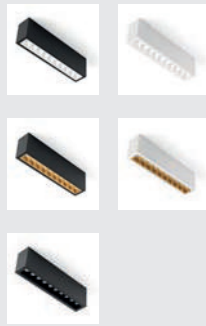

Family	Color T	Beam Angle	Finish	Anti-Glare	Control System
43709 Troop Surface 10x2W	927 2700K CRI90	1 15°	1 White	1 White	W CASAMBI
	930 3000K CRI90	3 36°	2 Black	2 Black	D DALI
	940 4000K CRI90	4 48°		4 Gold	C TRIAC ON/OFF

43709 927 1 1 1 W

Example 43709927111 — Troop Surface 10x2W 2700K 15° White White Casambi

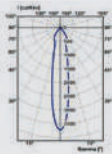

15°

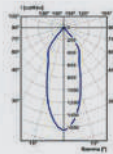

36°

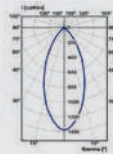

48°

Option	Color T	CRI	Power	Lumen Output	Beam Angle
927	2700K	90	10x2W	1379lm / 1681lm / 1755lm	15° / 36° / 48°
930	3000K	90	10x2W	1422lm / 1733lm / 1809lm	15° / 36° / 48°
940	4000K	90	10x2W	1465lm / 1785lm / 1863lm	15° / 36° / 48°

TROOP SURFACE WALLWASHER

incl. DIM 50.000hs L80 / B10 MacAdam 3 220-240V 650°C UGR <16

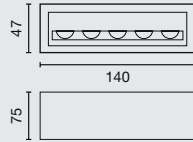

Family	Color T	Beam Angle	Finish	Anti-Glare	Control System
43711 Troop Surface Wall Washer 5x2W	927 2700K CRI90	0 Asym	1 White	1 White	C TRIAC ON/OFF
	930 3000K CRI90		2 Black	2 Black	
	940 4000K CRI90				

43711 927 1 1 1 C

Example **43711927111** — Troop Surface Wall Washer 5x2W 2700K Asym White White Triac

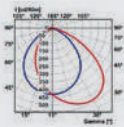

90°

Option	Color T	CRI	Power	Lumen Output	Beam Angle
927	2700K	90	5x2W	519lm	90°
930	3000K	90	5x2W	535lm	90°
940	4000K	90	5x2W	551lm	90°

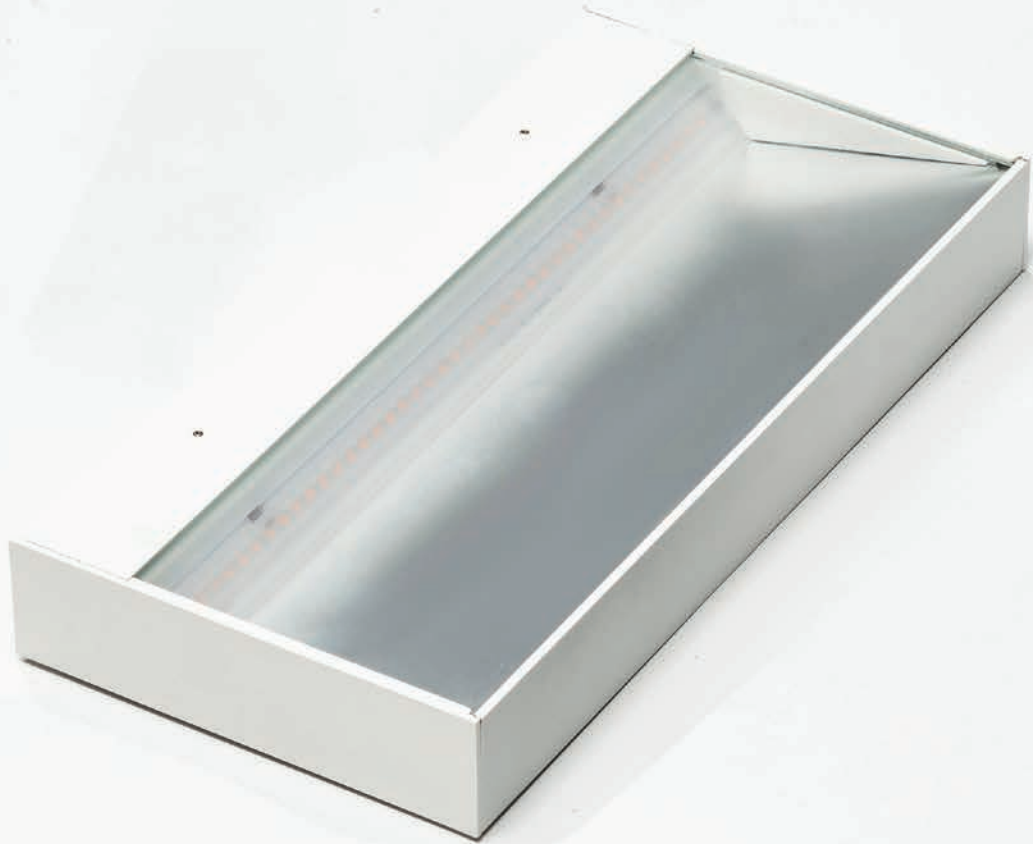

BLIT is a product with a minimalist design and a rectangular shape. Designed for surface installation on ceilings and walls, it provides indirect general lighting. Its elegant design seamlessly integrates into any environment, offering soft and ambient lighting that creates a cozy atmosphere. BLIT is the ideal choice for achieving discreet and effective lighting that enhances the aesthetics of the space.

BLIT es un producto de diseño minimalista y forma rectangular. Pensado para una instalación en superficie en techos y paredes, brinda una iluminación general de manera indirecta. Su diseño elegante se integra perfectamente en cualquier entorno, proporcionando una iluminación suave y ambiental que crea una atmósfera acogedora. BLIT es la elección ideal para lograr una iluminación discreta y efectiva que realza la estética del espacio.

BLIT

SURFACE



BLIT Collection



Track
53

MODULE
Modulo

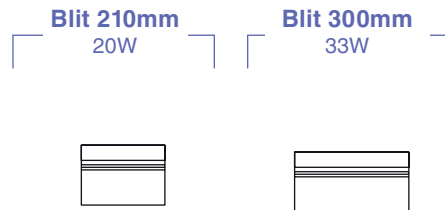

FINISH
Acabado



COLOR TEMPERATURE
Temperatura de color

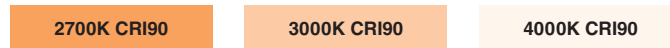

BEAM ANGLE
Ángulo de apertura

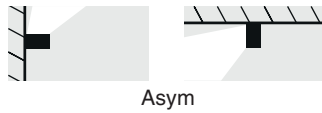

CONTROL SYSTEM
Sistema de control



Highlights

Available in two power options and made entirely of aluminium and glass, BLIT provides general illumination through indirect light. Its minimalist design with straight lines allows the luminaire to integrate perfectly into a wide range of spaces, whether installed on the wall or ceiling.

Disponible en dos opciones de potencia y fabricado íntegramente en aluminio y cristal, BLIT proporciona una iluminación general mediante luz indirecta. Su diseño minimalista de líneas rectas permite que la luminaria se integre perfectamente en una amplia gama de espacios, ya sea instalada en la pared o en el techo.

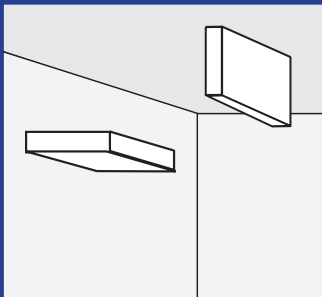

Wall & ceiling
Pared y Techo

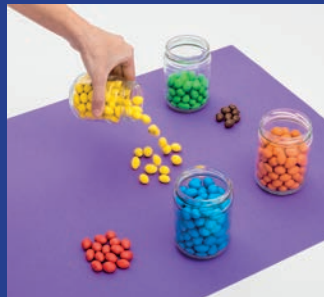

High CRI
Alto IRC

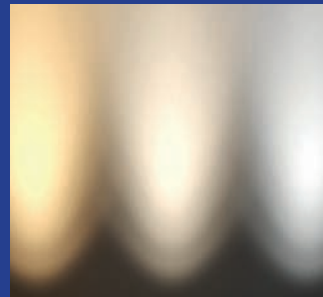

Several Color Temperatures
Varias Temperaturas de Color

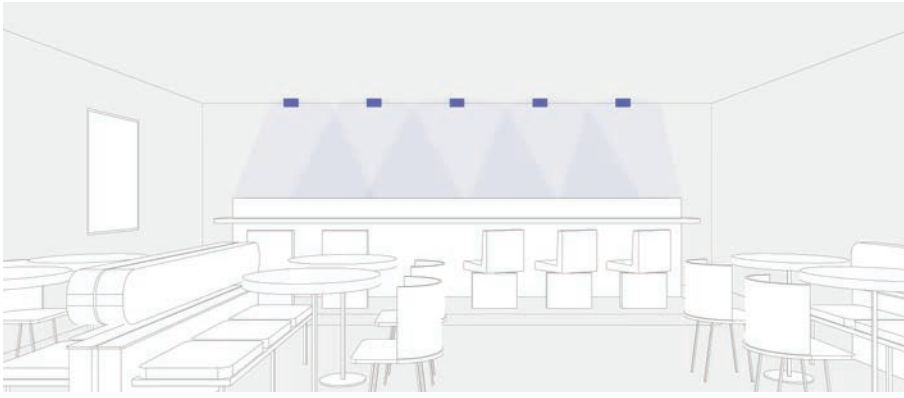

Restaurant

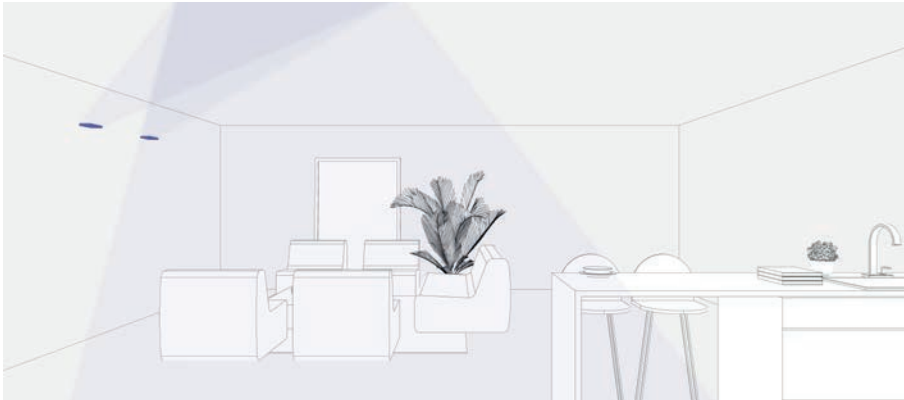

Home

Beam Angle

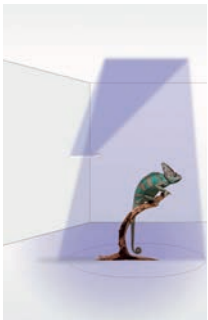

Asym°

BLIT

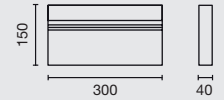
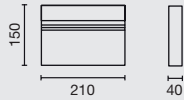
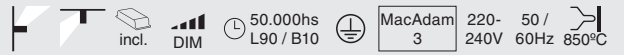

Family	Color T	Beam Angle	Finish	Control System
0125 Blit 210mm 20w	927 2700K CRI90	9 Asym	1 White	W CASAMBI
0126 Blit 300mm 33w	930 3000K CRI90		2 Black	D DALI
	940 4000K CRI90			ON/OFF

0125 **927** **9** **1** **D**

Example **012592791D** — Blit 210mm 20W 2700K CRI90 White Dali

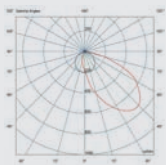

Asym

Option	Color T	CRI	Power	Lumen Output	Beam Angle
927	2700K	90	20W	1633lm	Asym
		90	33W	3412lm	Asym
930	3000K	90	20W	1684lm	Asym
		90	33W	3517lm	Asym
940	4000K	90	20W	1734lm	Asym
		90	33W	3623lm	Asym



The SCUBA UGR luminaire is a versatile and watertight solution suitable for surface or suspension installation. It provides high-quality lighting with a Unified Glare Rating (UGR) of less than 19, making it perfect for office environments. Its industrial style adds a touch of modernity and uniqueness to any workspace while providing efficient and comfortable lighting. It is the ideal choice for creating office environments with an industrial aesthetic and optimal lighting.

La luminaria SCUBA UGR es una solución versátil y estanca, adecuada para su instalación en superficie o suspensión. Brinda una iluminación de alta calidad con un valor UGR menor a 19, lo que la hace perfecta para entornos de oficina. Su estilo industrial añade un toque de modernidad y singularidad a cualquier espacio de trabajo, a la vez que proporciona una iluminación eficiente y confortable. Es la elección ideal para crear ambientes de oficina con una estética industrial y una iluminación óptima.



SCUBA





Office

Beam Angle

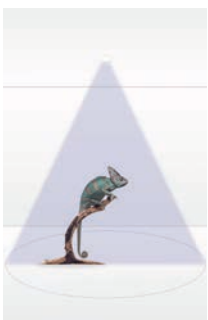

50°

MODULE

Modulo

Scuba 1200mm

36W



FINISH

Acabado

● **Black**
Negro

COLOR TEMPERATURE

Temperatura de color

3000K

4000K

ACCESSORIES

Accesorios



Suspended

CONTROL SYSTEM

Sistema de control



CASAMBI

Highlights

With a low UGR, this linear luminaire becomes the ideal choice for both office environments and industrial spaces requiring a high IP rating. In addition, its remarkable impact resistance ensures reliable performance even in demanding work environments.

Con un bajo índice de deslumbramiento UGR, esta luminaria lineal se convierte en la elección ideal tanto para entornos de oficina como para espacios industriales que requieran una clasificación de protección IP alta. Además, su notable resistencia al impacto garantiza un rendimiento confiable incluso en entornos de trabajo exigentes.

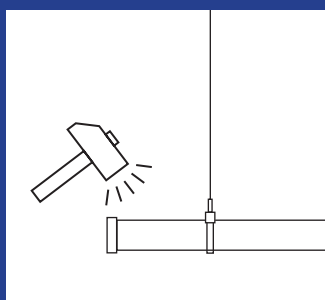

IK10



Suspended Option
Opción Colgante



IP65

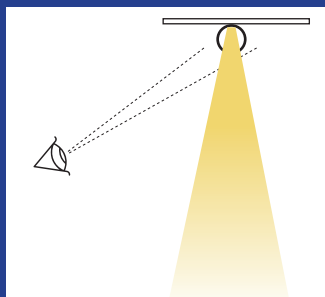

UGR < 19

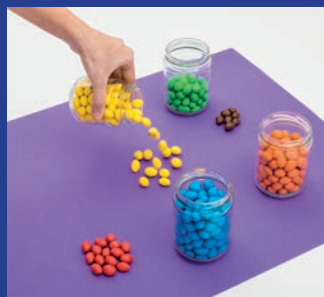

High CRI
Alto IRC

Accessories



Suspended

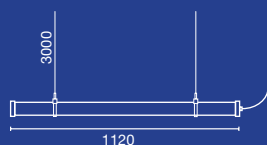

Suspended

● 042500099

Suspended DALI

● 042500099D

Architectural

Surface



SCUBA UGR 36W

incl. DIM 50.000hs L90 / B10 MacAdam 3 IP65 220-240V 50 / 60Hz 650°C

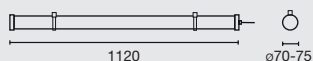

Family	Color T	Beam Angle	Finish	Control System
0425 Scuba UGR 36W	930 3000K CRI90 940 4000K CRI90	5 50°	2 Black	W CASAMBI D DALI ON/OFF

0425 930 5 2 W

Example **042593052W** — Scuba UGR 36W 3000K CRI90 50° Black Casambi

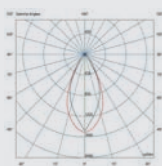

60°

Option	Color T	CRI	Power	Lumen Output	Beam Angle
930	3000K	90	36W	2946lm	50°
940	4000K	90	36W	3034lm	50°



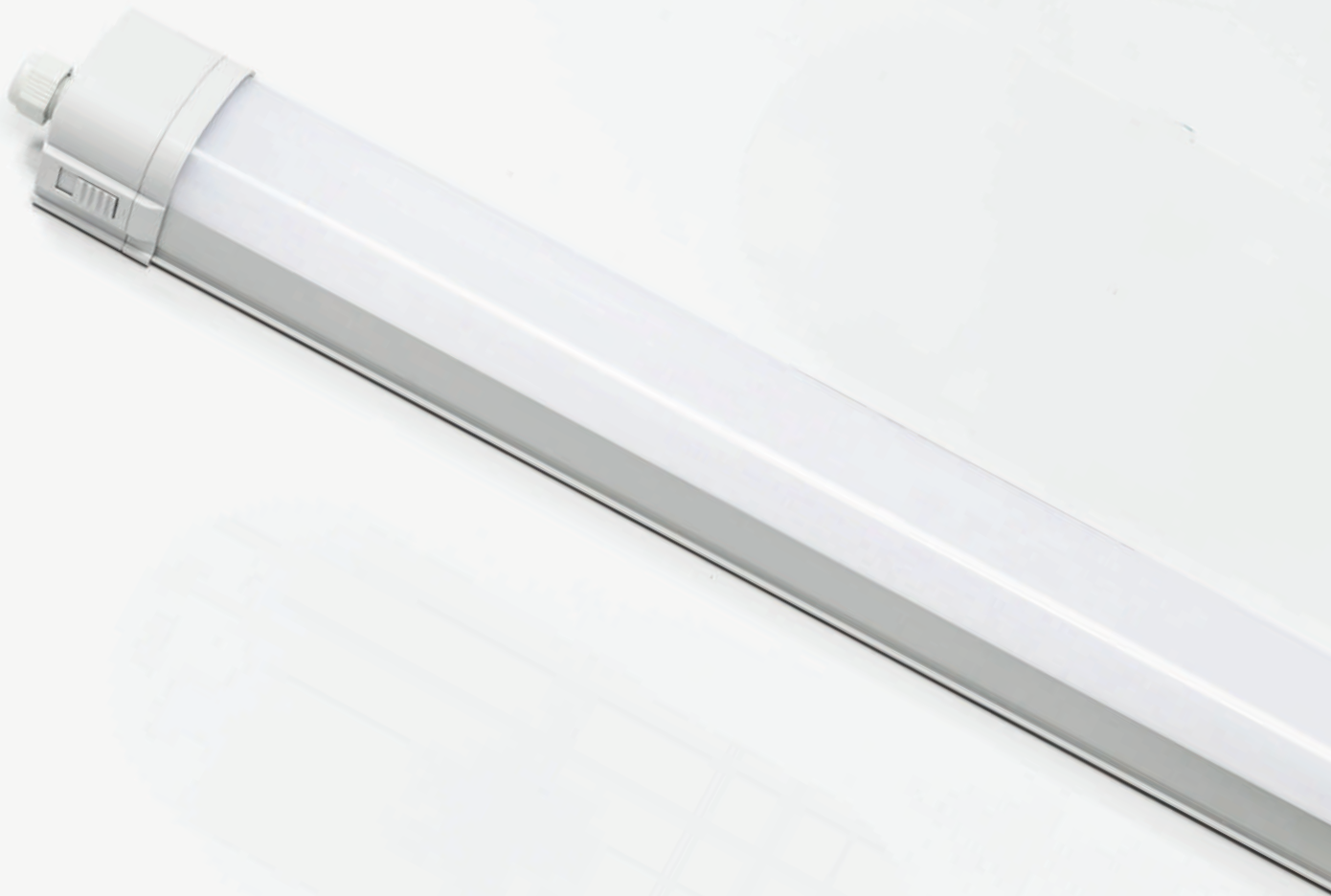

PROOFLINE is a robust and high-performance linear luminaire designed for demanding environments. With an IP67 rating, it offers exceptional resistance to water and dust, making it ideal for applications in parking lots and industrial spaces where durability and reliability are crucial. Thanks to its high luminous efficacy up to 150lm/w, it provides efficient and bright lighting while reducing energy consumption. It is an ideal solution for challenging environments that require durable and efficient lighting.

PROOFLINE es una luminaria lineal resistente y de alto rendimiento diseñada para entornos exigentes. Con clasificación IP67, ofrece una excepcional resistencia al agua y al polvo, lo que la hace ideal para aplicaciones en estacionamientos y espacios industriales donde la durabilidad y la fiabilidad son fundamentales. Gracias a su alta eficiencia lumínica de hasta 150lm/w, proporciona una iluminación eficiente y brillante a la vez que reduce el consumo energético. Es una solución ideal para entornos desafiantes que requieren de una iluminación duradera y eficiente.

PROOF LINE



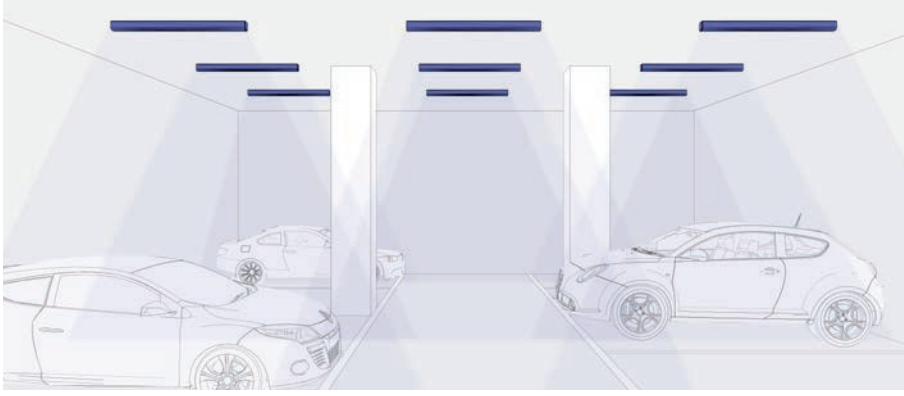

Parking

Beam Angle

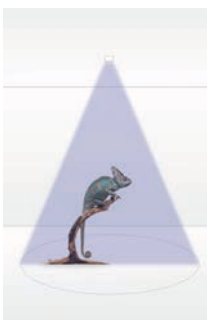

120°

MODULE
Modulo

Proofline

27 - 33 - 39 - 45W



FINISH
Acabado

White
Blanco

COLOR TEMPERATURE
Temperatura de color

3000K CRI80

4000K CRI80

CONTROL SYSTEM
Sistema de control



CASAMBI

Highlights

Its high efficiency makes this luminaire the ideal option for extensive spaces that demand constant illumination, such as parking lots. Its impact resistance ensures exceptional durability, ensuring flawless operation, providing reliable and long-lasting lighting over time.

Su alta eficiencia convierte a esta luminaria en la opción ideal para espacios extensos que demandan iluminación constante, como por ejemplo, parkings. Su resistencia al impacto garantiza una durabilidad excepcional, lo que asegura un funcionamiento impecable, proporcionando una iluminación fiable y duradera a lo largo del tiempo.



IP65

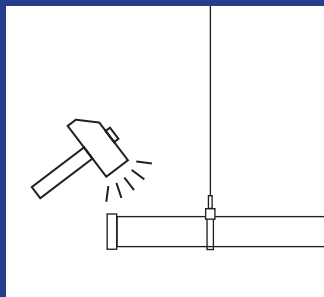

IK10



High Efficiency
Alta eficiencia

PROOFLINE 45W











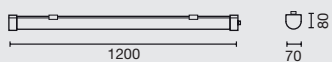

Family	Color T	Beam Angle	Finish	Control System
0424 Proofline 45W	830 3000K CRI80 840 4000K CRI80	9 120°	3 White	W CASAMBI D DALI ON/OFF

0424 **830** **9** **1** **D**

Example **042483091D** — Proofline 45W 3000K CRI80 120° White Dali

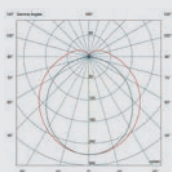

120°

Option	Color T	CRI	Power	Lumen Output	Beam Angle
830	3000k	80	27W	3915lm	120°
840	4000k	80	27W	4032lm	120°
830	3000k	80	33W	4766lm	120°
840	4000k	80	33W	4908lm	120°
830	3000k	80	39W	5576lm	120°
840	4000k	80	39W	5743lm	120°
830	3000k	80	45W	6369lm	120°
840	4000k	80	45W	6914lm	120°

*This product integrates a driver that allows manual adjustment of power. To change the power, please refer to the instructions.
 *Este producto integra un driver que permite cambiar la potencia de forma manual. Para realizar el cambio de potencia consultar el instructivo.

FOST SURFACE meets the need to accentuate what needs to be highlighted. A minimalist design that is easy to integrate into any space, bringing the architecture to the forefront. It can be installed on both the vertical and horizontal plane without the need for a track.

FOST SURFACE da risposta a la necesidad de poner acento a lo que debe ser destacado. Un diseño minimalista de fácil integración en cualquier espacio dando protagonismo a la arquitectura. Su instalación es posible tanto en el plano vertical como horizontal sin la necesidad de la utilización de carril.



F O S T



S U R F A C E



FOST Collection



Track
41



Recessed
223



Pulldown
231



Ceiling
343



Suspended
391

MODULE
Modulo

Fost ø64
7/14W

Fost ø70
28W

Fost ø90
42W

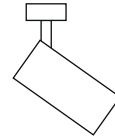
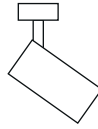
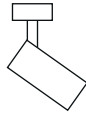

FINISH
Acabado

● **Black**
Negro

○ **White**
Blanco

COLOR TEMPERATURE
Temperatura de color

2700K CRI90

3000K CRI90

4000K CRI90

2700K CRI97

3000K CRI97

4000K CRI97

MEAT

BREAD

FASHION

BEAM ANGLE
Ángulo de apertura

18°

24°

36°

60°

ACCESSORIES
Accesorios



Honeycomb



Long Snoot



Striped Glass



Spread Glass



White Ring



Copper Ring

CONTROL SYSTEM
Sistema de control





White Ring
Anillo blanco



Copper Ring
Anillo cobre



Striped Glass
Vidrio estriado



Long Snoot
Visera larga

Its multiple accessories and combinations facilitate the personalisation of the products, giving it certain architectural relevance and at the same time making it possible to modify the beam or reduce glare.

Sus múltiples accesorios y combinaciones facilitan la personalización del producto que hace posible la modificación de haz o reducir el deslumbramiento.



Spread Glass
Vidrio difusor

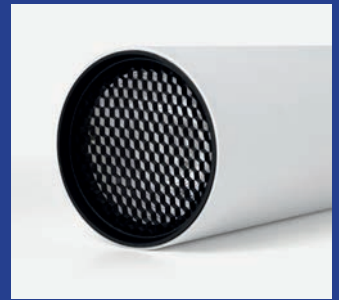

Honeycomb
Panel de abeja



Without Accessory



Spread Glass



Striped Glass

Accessories

	Honeycomb	White Ring	Copper Ring	Spread Glass	Long Snoot	Striped Glass
ø64	011700094	011700099	011700098	011700097	011700095	011700096
ø70	011800094	011800099	011800098	011800097	011800095	011800096
ø90	012100094	012100099	012100098	012100097	012100095	012100096

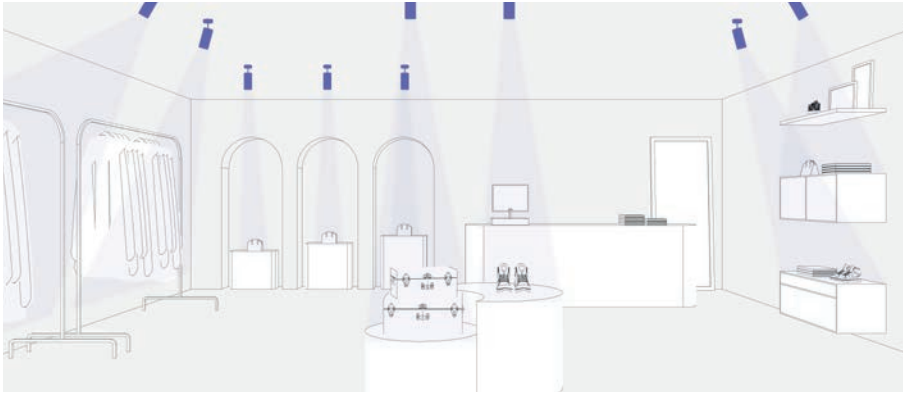

Retail



Restaurant

Beam Angle



18°

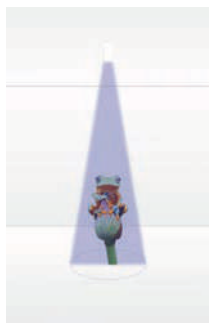

24°

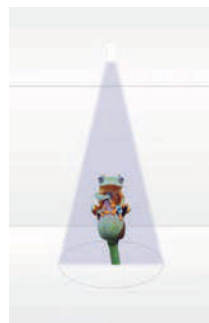

36°



60°

FOST SURFACE $\varnothing 70$

incl. DIM 355° 90° 50.000hs L70 / B10 MacAdam 2&3 220-240V 50 / 60Hz 650°C

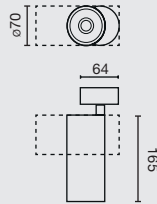

Family	Color T	Beam Angle	Finish	Control System
0120 Fost surface $\varnothing 70$ 28W	927 2700K CRI90	1 18° 2 24° 3 36° 6 60°	1 White	C TRIAC ON/OFF
	930 3000K CRI90		2 Black	
	940 4000K CRI90			
	X27 2700K CRI97			
	X30 3000K CRI97			
	X40 4000K CRI97			

0120 927 1 1 C

Example **012092711C** — Fost Surface $\varnothing 70$ 28W 2700K CRI90 18° White Triac

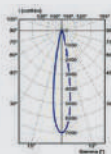

18°

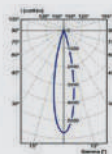

24°

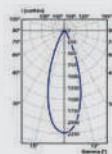

36°

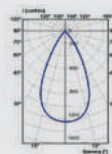

60°

Option	Color T	CRI	Power	Lumen Output	Beam Angle
927	2700K	90	28W	2982lm / 2987lm / 2732lm / 2436lm	18° / 24° / 36° / 60°
X27		97	28W	2684lm / 2688lm / 2459lm / 2193lm	18° / 24° / 36° / 60°
930	3000K	90	28W	3075lm / 3080lm / 2817lm / 2512lm	18° / 24° / 36° / 60°
X30		97	28W	2767lm / 2771lm / 2535lm / 2261lm	18° / 24° / 36° / 60°
940	4000K	90	28W	3167lm / 3172lm / 2902lm / 2588lm	18° / 24° / 36° / 60°
X40		97	28W	2850lm / 2855lm / 2611lm / 2328lm	18° / 24° / 36° / 60°

FOST SURFACE ø90

incl. DIM 355° 90° 50.000hs L70 / B10 MacAdam 2&3 220-240V 50 / 60Hz 650°C

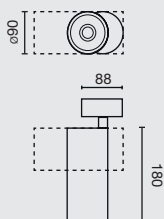

Family	Color T	Beam Angle	Finish	Control System
0121 Fost surface ø90 42W	927 2700K CRI90	1 18° 2 23° 3 38°	1 White	D
	930 3000K CRI90		2 Black	C
	940 4000K CRI90			ON/OFF
	X27 2700K CRI97			
	X30 3000K CRI97			
	X40 4000K CRI97			
	MT MEAT			
	BR BREAD			
	FS FASHION			

0121 927 1 1 C

Example 012192711C — Fost Surface ø90 28W 2700K CRI90 18° White Triac

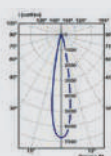

18°

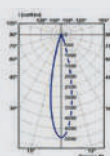

24°

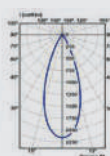

36°

Option	Color T	CRI	Power	Lumen Output	Beam Angle
927	2700K	90	42W	3374lm / 3656lm / 3856lm	18° / 24° / 36°
X27	2700K	97	42W	3036lm / 3290lm / 3470lm	18° / 24° / 36°
930	3000K	90	42W	3478lm / 3769lm / 3975lm	18° / 24° / 36°
X30	3000K	97	42W	3130lm / 3392lm / 3577lm	18° / 24° / 36°
940	4000K	90	42W	3582lm / 3882lm / 4094lm	18° / 24° / 36°
X40	4000K	97	42W	3224lm / 3493lm / 3684lm	18° / 24° / 36°
MT	3100K	-	42W	2468lm / 2688lm / 2819lm	18° / 24° / 36°
BR	2500K	-	42W	3330lm / 3627lm / 3803lm	18° / 24° / 36°
FS	3100K	-	42W	3418lm / 3723lm / 3903lm	18° / 23° / 36°



Surface light fixture suitable for ceilings which do not offer recessed mounting. The versatility of sizes and optics of FOST CEILING makes it a perfect fixed overhead application solution for commercial spaces, hotels, restaurants, retail and even domestic spaces due to its various colour temperature and CRI options.

Luminaria de superficie indicada para techos sin posibilidad de empotramiento. La versatilidad de tamaños y ópticas de FOST CEILING lo convierten en una solución perfecta de aplicación fija cenital para espacios comerciales, hoteles, restauración, retail e incluso espacios domésticos por sus varias opciones en temperatura de color y IRC.



F O O S T



C E I L I N G



FOST Collection



Track
41



Recessed
223



Pulldown
231



Surface
333



Suspended
391

MODULE
Modulo

Fost ø64
7/14W

Fost ø70
28W

Fost ø90
42W



FINISH
Acabado

Black
Negro

White
Blanco

COLOR TEMPERATURE
Temperatura de color

2700K CRI90

3000K CRI90

4000K CRI90

2700K CRI97

3000K CRI97

4000K CRI97

MEAT

BREAD

FASHION

BEAM ANGLE
Ángulo de apertura

18°

24°

36°

60°

ACCESSORIES
Accesorios



Honeycomb



Long Snoot



Striped Glass



Spread Glass



White Ring



Copper Ring

CONTROL SYSTEM
Sistema de control





White Ring
Anillo Blanco



Copper Ring
Anillo Cobre



Striped Glass
Vidrio Estriado



Long Snoot
Visera Larga

Its multiple accessories and combinations facilitate the the personalisation of the product, giving it certain architectural relevance and at the same time making it possible to modify the beam or reduce glare.

Sus múltiples accesorios y combinaciones facilitan la personalización del producto, que hace posible la modificación de haz o reducir el deslumbramiento.



Spread Glass
Vidrio Difusor



Honeycomb
Panel de Abeja



Without Accessory



Spread Glass



Striped Glass

Accessories

	Honeycomb	White Ring	Copper Ring	Spread Glass	Long Snoot	Striped Glass
ø64	011700094	011700099	011700098	011700097	011700095	011700096
ø70	011800094	011800099	011800098	011800097	011800095	011800096
ø90	012100094	012100099	012100098	012100097	012100095	012100096



Retail



Restaurant

Beam Angle



18°



24°

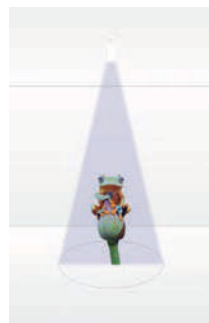

36°



60°

FOST CEILING ϕ 70

incl. 50.000hs L80 / B10 MacAdam 2&3 220-240V 50 / 60Hz 650°C



Family	Color T	Beam Angle	Finish	Control System
0511 Fost ceiling ϕ 70 28W	927 2700K CRI90	1 18°	1 White	C ON/OFF
	930 3000K CRI90	2 23°	2 Black	
	940 4000K CRI90	3 36°		
	X27 2700K CRI97	6 60°		
	X30 3000K CRI97			
	X40 4000K CRI97			

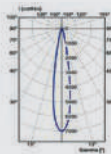

18°

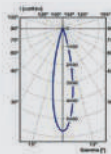

23°

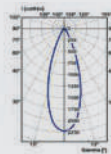

36°

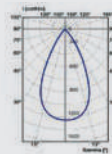

60°

Option	Color T	CRI	Power	Lumen Output	Beam Angle
927	2700K	90	28W	2982lm / 2987lm / 2732lm / 2436lm	18° / 23° / 36° / 60°
X27		97	28W	2684lm / 2688lm / 2459lm / 2193lm	18° / 23° / 36° / 60°
930	3000K	90	28W	3075lm / 3080lm / 2817lm / 2512lm	18° / 23° / 36° / 60°
X30		97	28W	2767lm / 2771lm / 2535lm / 2261lm	18° / 23° / 36° / 60°
940	4000K	90	28W	3167lm / 3172lm / 2902lm / 2588lm	18° / 23° / 36° / 60°
X40		97	28W	2850lm / 2855lm / 2611lm / 2328lm	18° / 23° / 36° / 60°

FOST CEILING ø90

incl. DIM 50.000hs L70 / B10 MacAdam 2&3 220-240V 50 / 60Hz 650°C



Family	Color	Beam Angle	Finish	Control System
0512 Fost ceiling ø90 42W	927 2700K CRI90	1 18° 2 23° 3 38°	1 White	D DALI
	930 3000K CRI90		2 Black	C TRIAC
	940 4000K CRI90			ON/OFF
	X27 2700K CRI97			
	X30 3000K CRI97			
	X40 4000K CRI97			
	MT MEAT			
	BR BREAD			
	FS FASHION			

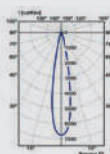

18°

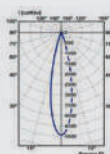

23°



38°

Option	Color T	CRI	Power	Lumen Output	Beam Angle
927	2700K	90	42W	3374lm / 3656lm / 3856lm	18° / 23° / 38°
X27	2700K	97	42W	3036lm / 3290lm / 3470lm	18° / 23° / 38°
930	3000K	90	42W	3478lm / 3769lm / 3975lm	18° / 23° / 38°
X30	3000K	97	42W	3130lm / 3392lm / 3577lm	18° / 23° / 38°
940	4000K	90	42W	3582lm / 3882lm / 4094lm	18° / 23° / 38°
X40	4000K	97	42W	3224lm / 3493lm / 3684lm	18° / 23° / 38°
MT	3100K	-	42W	2468lm / 2688lm / 2819lm	18° / 23° / 38°
BR	2500K	-	42W	3330lm / 3627lm / 3803lm	18° / 23° / 38°
FS	3100K	-	42W	3418lm / 3723lm / 3903lm	18° / 23° / 38°



PODIUM is a modular system of recessed and surface light fixtures which offers different light effects and configurations, enabling the creation of different climates with an integrated aesthetic. One product, one project, infinite possibilities.

PODIUM es un sistema modular de luminarias de empotrar y de superficie que ofrece diferentes efectos lumínicos y configuraciones permitiendo generar diversos climas con una estética integrada. Un producto, un proyecto, infinitas posibilidades.

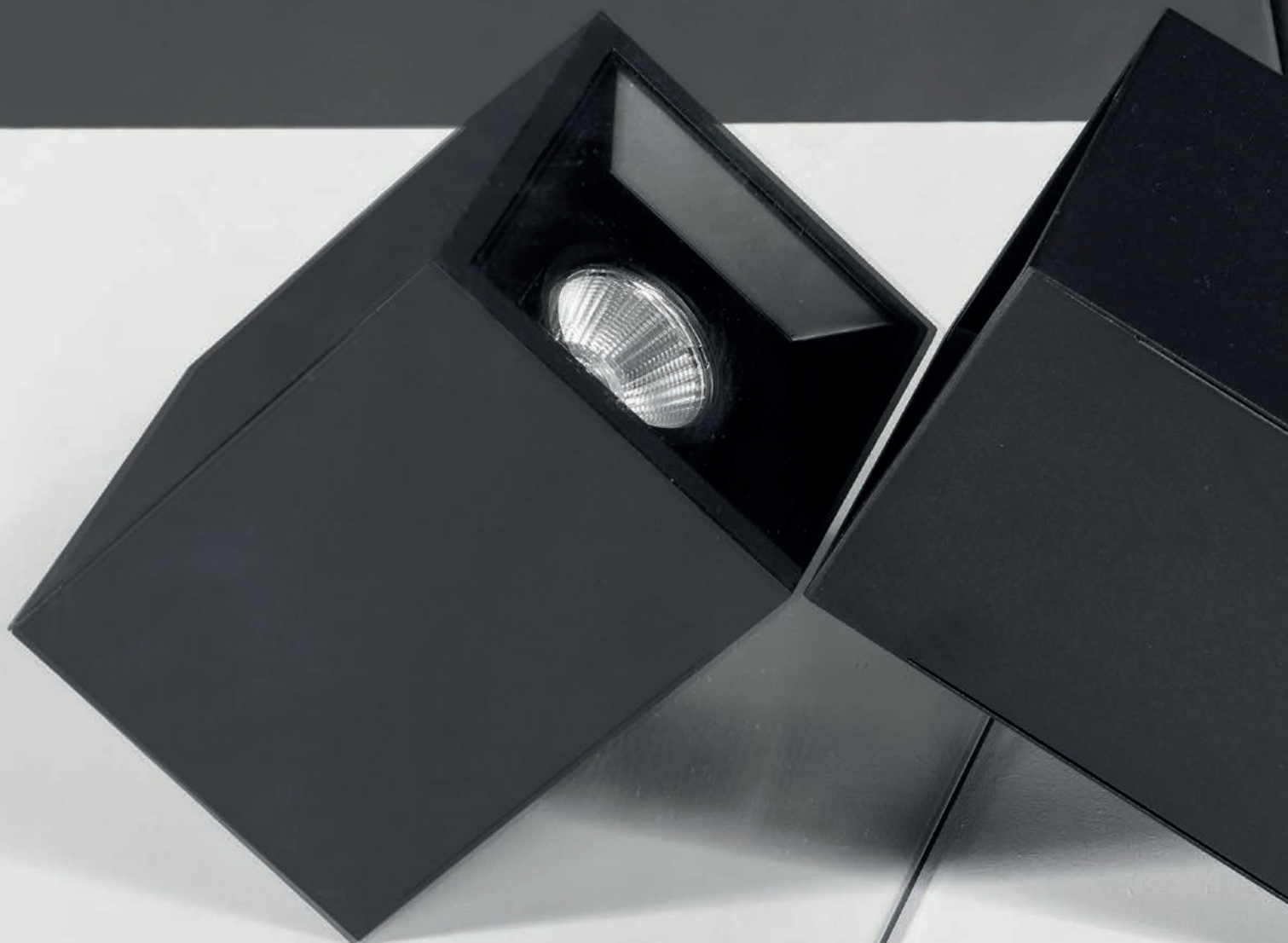

PODIUM



SURFACE



PODIUM Collection



Recessed
251

MODULE
Modulo

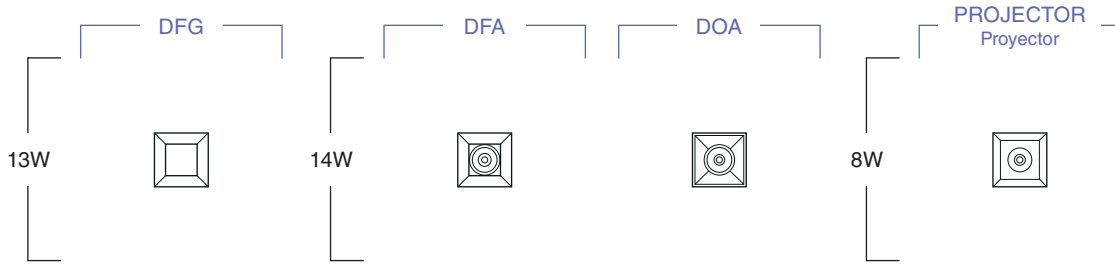

SURFACE BOX
Caja de superficie

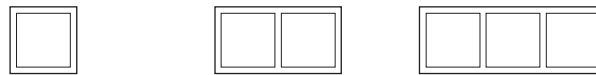

108x108

108x206

108x304

FINISH
Acabado

● **Black**
Negro

○ **White**
Blanco

COLOR TEMPERATURE
Temperatura de color

2700K CRI97

3000K CRI97

4000K CRI97

2700K CRI90

3000K CRI90

4000K CRI90

BEAM ANGLE
Ángulo de apertura

18°

24°

36°

60°

90°

100°

ACCESSORIES
Accesorios



Honeycomb



Striped Glass



Diffusion Sheet

CONTROL SYSTEM
Sistema de control



CASAMBI



Highlights



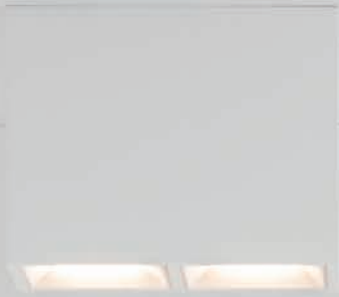



Surface Box 1L

Surface Box 2L

Surface Box 3L

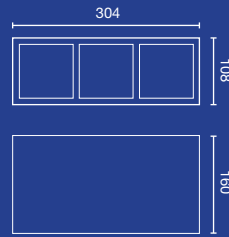
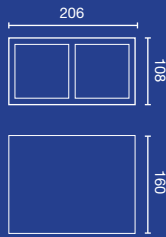
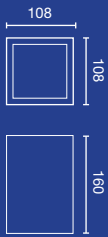

Honeycomb
Panel de Abeja

Stripped Glass
Vidrio Estriado

Diffusion Sheet
Lámina Difusora

Surface box

Accessories for DFA&DOA

	Surface Box 1L	Surface Box 2L	Surface Box 3L
●	051300011	051400021	051500031
●	051300012	051400022	051500032

	Honeycomb	Stripped Glass	Diffusion Sheet
	034100098	034100097	034100099



Residential



Restaurant

Beam Angle



18°



24°



36°



60°

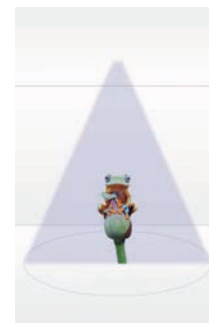

90°

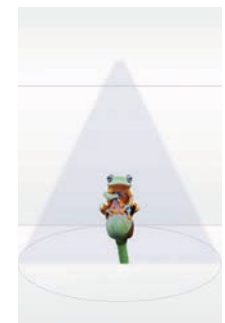

110°

PODIUM DFA MODULE

incl. DIM 50.000hs L70 / B10 MacAdam 3 220-240V 50 / 60Hz 650°C



Family	Color T	Beam Angle	Finish	Control System
0341 Podium DFA Module 15W	927 2700K CRI97	1 15°	1 White	W CASAMBI
	930 3000K CRI97	2 24°	2 Black	D DALI
	940 4000K CRI97	3 38°		C TRIAC
		6 60°		ON/OFF

0341 927 1 1 W

Example 034192711W — Podium DFA Module 15W 2700K CRI97 15° White Casambi

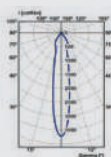

18°

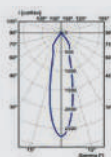

24°

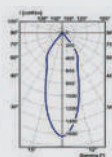

36°



60°

Option	Color T	CRI	Power	Lumen Output	Beam Angle
X27	2700K	97	15W	1121lm / 1026lm / 1036lm / 1060lm	18° / 24° / 36° / 60°
X30	3000K	97	15W	1156lm / 1058lm / 1068lm / 1093lm	18° / 24° / 36° / 60°
X40	4000K	97	15W	1191lm / 1090lm / 1100lm / 1126lm	18° / 24° / 36° / 60°

See surface box options on pag 358
Ver opciones de caja en página 358

PODIUM DOA MODULE

incl. DIM 355° 20° 50.000hs L70 / B10 MacAdam 3 220-240V 50 / 60Hz 650°C

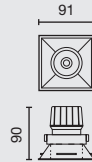

Family	Color T	Beam Angle	Finish	Control System
0342 Podium DOA Module 15W	927 2700K CRI97	1 15°	1 White	W CASAMBI
	930 3000K CRI97	2 24°	2 Black	D DALI
	940 4000K CRI97	3 38°		C TRIAC
		6 60°		ON/OFF

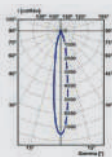

18°

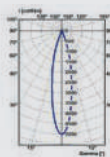

24°

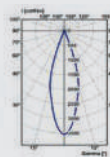

36°

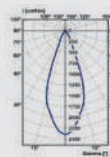

60°

Option	Color T	CRI	Power	Lumen Output	Beam Angle
X27	2700K	97	15W	435lm / 439lm / 448lm / 456lm	18° / 24° / 36° / 60°
X30	3000K	97	15W	448lm / 453lm / 462lm / 470lm	18° / 24° / 36° / 60°
X40	4000K	97	15W	461lm / 467lm / 476lm / 484lm	18° / 24° / 36° / 60°

See surface box options on pag 358
Ver opciones de caja en página 358

PODIUM DFG MODULE

incl. DIM 50.000hs L70 / B10 MacAdam 3 220-240V 50 / 60Hz 650°C

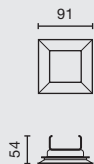

Family	Color T	Beam Angle	Finish	Control System								
0343 Podium DFG Module 13W	927 2700K CRI90	0 110°	1 White	<table border="1"> <tr><td>W</td><td>CASAMBI</td></tr> <tr><td>D</td><td>DALI</td></tr> <tr><td>C</td><td>TRIAC</td></tr> <tr><td></td><td>ON/OFF</td></tr> </table>	W	CASAMBI	D	DALI	C	TRIAC		ON/OFF
	W		CASAMBI									
	D		DALI									
C	TRIAC											
	ON/OFF											
930 3000K CRI90	2 Black											
940 4000K CRI90												

0343 927 0 1 W

Example 034392711W — Podium DFA Module 13W 2700K CRI90 110° White Casambi

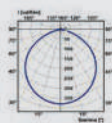

110°

Option	Color T	CRI	Power	Lumen Output	Beam Angle
927	2700K	90	13W	648lm	110°
930	3000K	90	13W	668lm	110°
940	4000K	90	13W	688lm	110°

See surface box options on pag 358
Ver opciones de caja en página 358

PODIUM PROJECTOR MODULE

incl. DIM 355° 90° 50.000hs L80 / B10 MacAdam 3 220-240V 50 / 60Hz 650°C

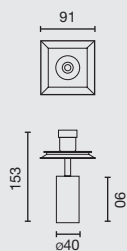

Family	Color T	Beam Angle	Finish	Control System
0345 Podium Projector Module 8W	927 2700K CRI97	1 15°	1 White	W CASAMBI
	930 3000K CRI97	2 25°	2 Black	D DALI
	940 4000K CRI97			C TRIAC ON/OFF

0345 927 1 1 W

Example 034392711W — Podium Projector Module 8W 2700K CRI97 15° White Casambi

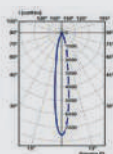

18°

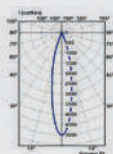

24°

Option	Color T	CRI	Power	Lumen Output	Beam Angle
X27	2700K	97	8W	273lm / 273lm	18° / 24°
X30	3000K	97	8W	281lm / 281lm	18° / 24°
X40	4000K	97	8W	289lm / 289lm	18° / 24°

See surface box options on pag 358
Ver opciones de caja en página 358

S U S P

ENDED

Our TAK pendant luminaire provides diffuse illumination designed for tasks requiring sustained attention and ambient clarity. It offers visual comfort, pleasant light quality, and high luminous efficiency. The industrial aesthetic of this pendant adds character and visual presence to any architectural setting.

Nuestra luminaria TAK colgante ofrece luz difusa diseñada para acompañar tareas que requieren atención sostenida y claridad ambiental. Aporta confort visual y una luz agradable, con una gran eficiencia lumínica. La estética industrial de esta luminaria colgante aporta carácter y presencia visual en cualquier espacio.



TAK

NEW



S U S P E N D E D



TAK Collection



Surface
273

MODULE
Modulo

TAK
Suspended

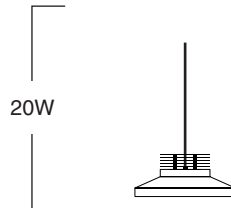

FINISH
Acabado

● **Black**
Negro

○ **White**
Blanco

COLOR TEMPERATURE
Temperatura de color

2700K CRI90

3000K CRI90

4000K CRI90

BEAM ANGLE
Ángulo de apertura



CONTROL SYSTEM
Sistema de control



CASAMBI



Highlights



High CRI
Alto IRC

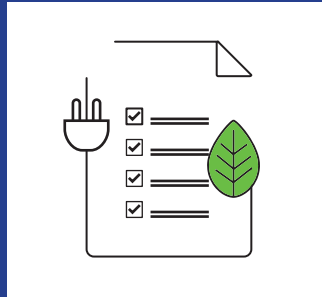

High Efficiency
Alta eficiencia

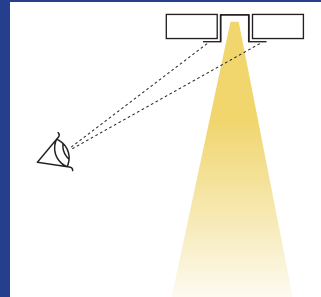

UGR < 19



Microprsim
Microprisma



Compatible with FARO fans*
Compatible con ventiladores FARO

*Check out the FAN catalogue.
Echa un vistazo al catálogo FAN.



Office

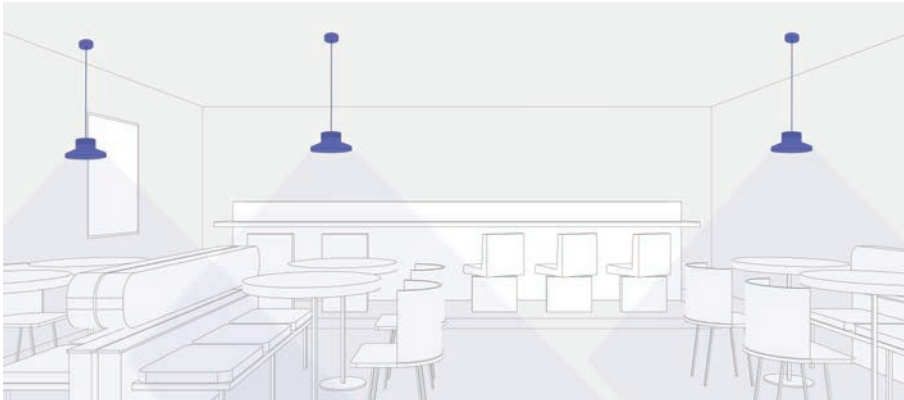

Restaurant

Beam Angle

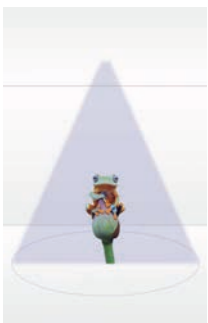

90°

TAK SUSPENDED

NEW

incl. DIM 50.000hs L70 / B10 MacAdam 3 110-277V 650°C UGR <19

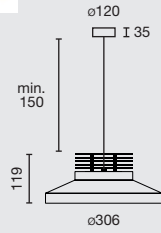

Family	Color T	Diffuser	Finish	Control System								
0431 Tak Suspended 20W	927 2700K CRI90	1 Microprism	1 White	<table border="1"> <tr> <td>W</td> <td>CASAMBI</td> </tr> <tr> <td>D</td> <td></td> </tr> <tr> <td>C</td> <td></td> </tr> <tr> <td></td> <td>ON/OFF</td> </tr> </table>	W	CASAMBI	D		C			ON/OFF
	W		CASAMBI									
	D											
C												
	ON/OFF											
930 3000K CRI90	2 Black											
940 4000K CRI90												

0431 927 1 2 W

Example **043192712W** — Tak Suspended 20W 2700K CRI90 Microprism Black Casambi

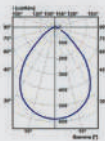

90°

Option	Color T	CRI	Power	Lumen Output	Beam Angle
927	2700K	90	20W	1940lm	90°
930	3000K	90	20W	2000lm	90°
940	4000K	90	20W	2060lm	90°



Our TEK pendant luminaire provides accent lighting with high color fidelity over a specific target area, creating focused atmospheres that blend visual clarity with understated elegance. Its industrial aesthetic adds character and a strong visual presence to any space.

Nuestra luminaria TEK colgante ofrece luz de acento con fidelidad cromática sobre una zona específica deseada, generando atmósferas focalizadas que fusionan sobriedad y bienestar. La estética industrial de esta luminaria colgante aporta carácter y presencia visual en cualquier espacio.



TEK

NEW



S U S P E N D E D



TEK Collection



Surface
285

376

MODULE
Modulo

TEK
Suspended

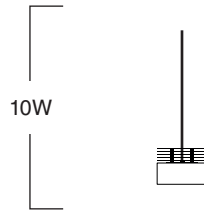

FINISH
Acabado

● **Black**
Negro

○ **White**
Blanco

COLOR TEMPERATURE
Temperatura de color

2700K CRI90

3000K CRI90

4000K CRI90

BEAM ANGLE
Ángulo de apertura

40°

CONTROL SYSTEM
Sistema de control



Highlights

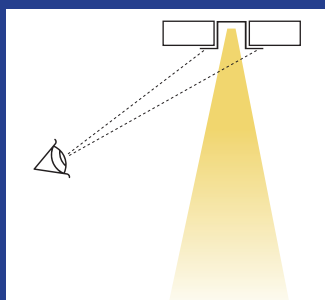

UGR<16



Several color temperatures
Varias temperaturas de color



Compatible with FARO fans*
Compatible con ventiladores FARO

*Check out the FAN catalogue.
Echa un vistazo al catálogo FAN.



Residential

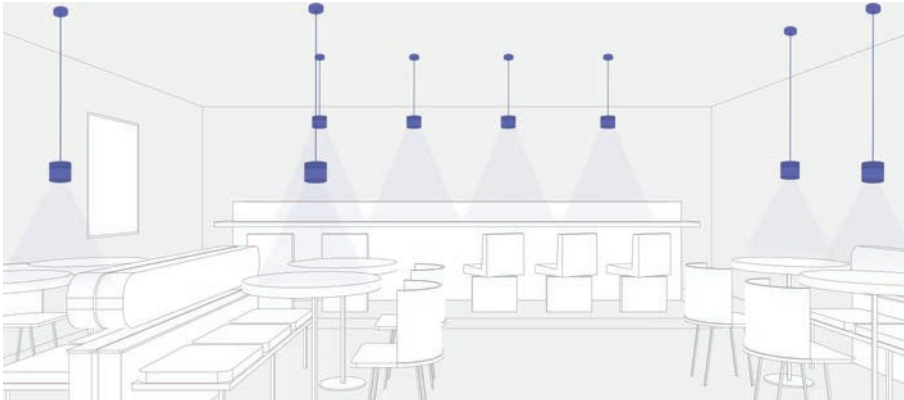

Restaurant

Beam Angle



40°

TEK SUSPENDED

NEW

incl. DIM 50.000hs L70 / B10 MacAdam 3 220-240V 650°C UGR <16

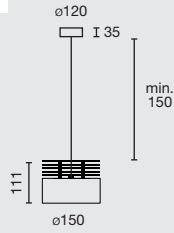

Family	Color T	Beam Angle	Finish	Control System
0433 Tek Suspended 10W	927 2700K CRI90	4 40°	1 White	C TRIAC
	930 3000K CRI90		2 Black	
	940 4000K CRI90			

0433 927 4 2 C

Example 043392742C — Tek Suspended 10W 2700K CRI90 40° Black Triac

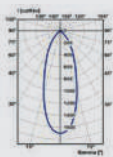

40°

Option	Color T	CRI	Power	Lumen Output	Beam Angle
927	2700K	90	10W	750	40°
930	3000K	90	10W	774	40°
940	4000K	90	10W	798	40°



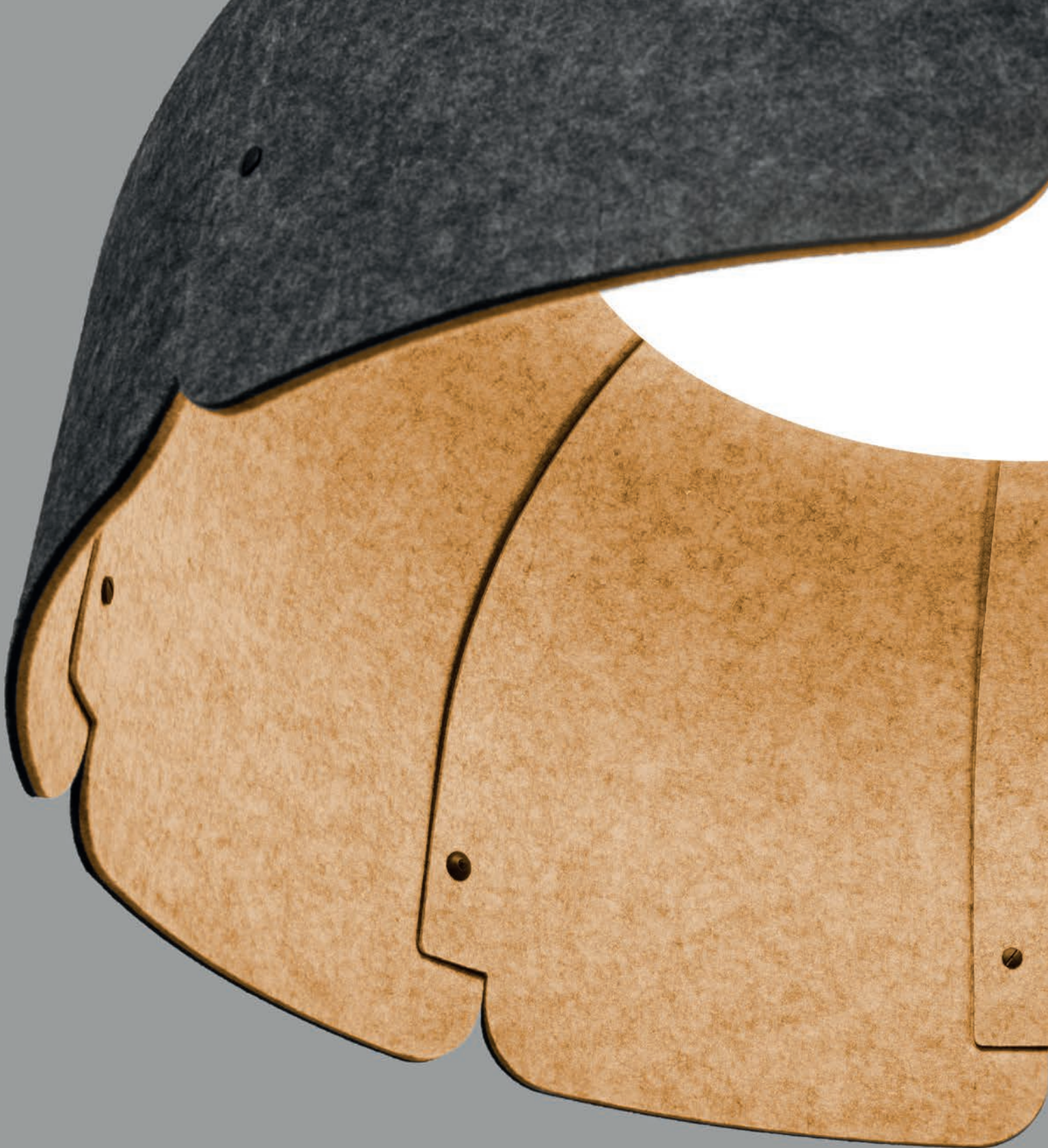

MUTE makes quite a splash. It is not only a suspension light, but also a way of achieving relaxed spaces and inviting communication. Its textile fabric absorbs reverberation and contributes to the reduction of environmental noise.

MUTE no es sólo una luminaria de suspensión. Es la forma de conseguir espacios relajados y que inviten a la comunicación. Su tejido textil absorbe la reverberación y contribuye a la reducción del ruido ambiental.

Designed by Faro Lab



GERMAN
DESIGN
AWARD
SPECIAL
2019

MUTE



Designed by Faro Lab



MODULE
Modulo

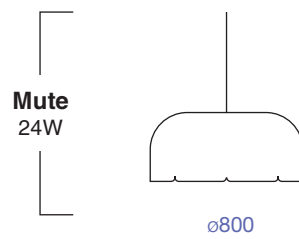

FINISH
Acabado

- **Dark Grey+Grey**
Gris oscuro+Gris
- **Dark Grey+Brown**
Gris oscuro+Marrón

COLOR TEMPERATURE
Temperatura de color

3000K CRI>80

4000K CRI>80

CONTROL SYSTEM
Sistema de control



Highlights



Recycled PET

PET reciclado

Because polyester accounts for approximately 60 percent of the world's production of PET, developing a non-virgin supply chain for polyester fiber has the potential to massively impact global energy and resource requirements.

Debido a que el poliéster representa aproximadamente el 60 por ciento de la producción mundial de PET, el desarrollo de una cadena de suministro no virgen para la fibra de poliéster tiene el potencial de impactar masivamente los requerimientos globales de energía y recursos.



Sound Absorbing $\alpha = 0.9$

Absorción acústica $\alpha = 0,9$

Noise in offices and workplaces has direct consequences on worker performance. The most immediate one is the reduction of their concentration. Workers exposed to continuous noise in their workplace are less effective in their work tasks. Concentration often means giving the brain a break to think better and focus on an activity. Luminaires made from fabrics with noise-absorbing properties are perfect for work spaces with high noise levels and acoustic distractions.

El ruido en las oficinas y lugares de trabajo tiene consecuencias directas en el rendimiento de los trabajadores. La más inmediata es la reducción de su concentración. Los trabajadores expuestos a un ruido continuo en su lugar de trabajo son menos eficaces en sus tareas. La concentración suele significar dar un respiro al cerebro para pensar mejor y centrarse en una actividad. Las luminarias fabricadas con tejidos con propiedades de absorción del ruido son perfectas para espacios de trabajo con altos niveles de ruido y distracciones acústicas.

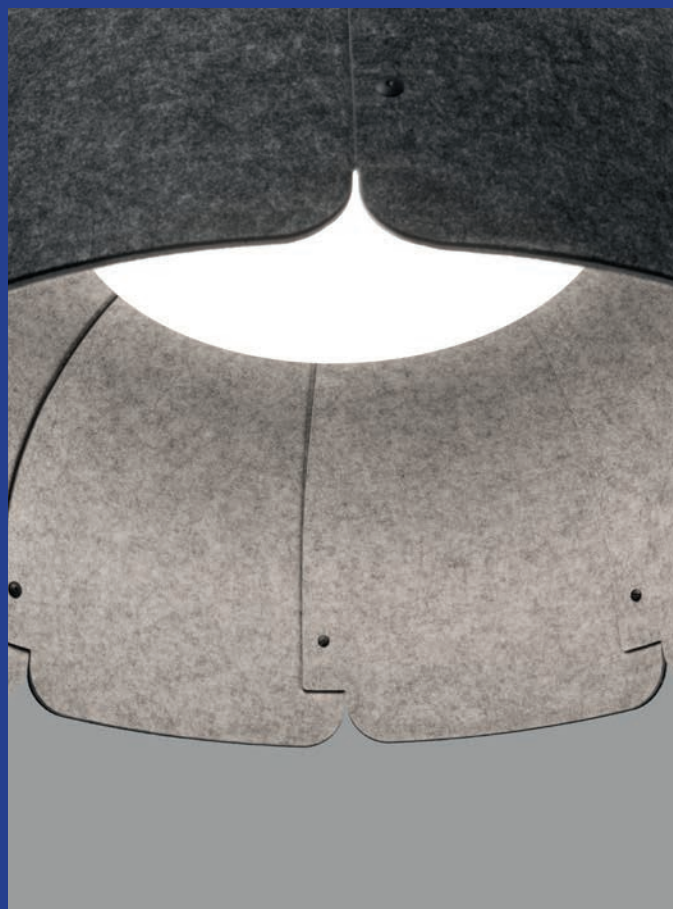
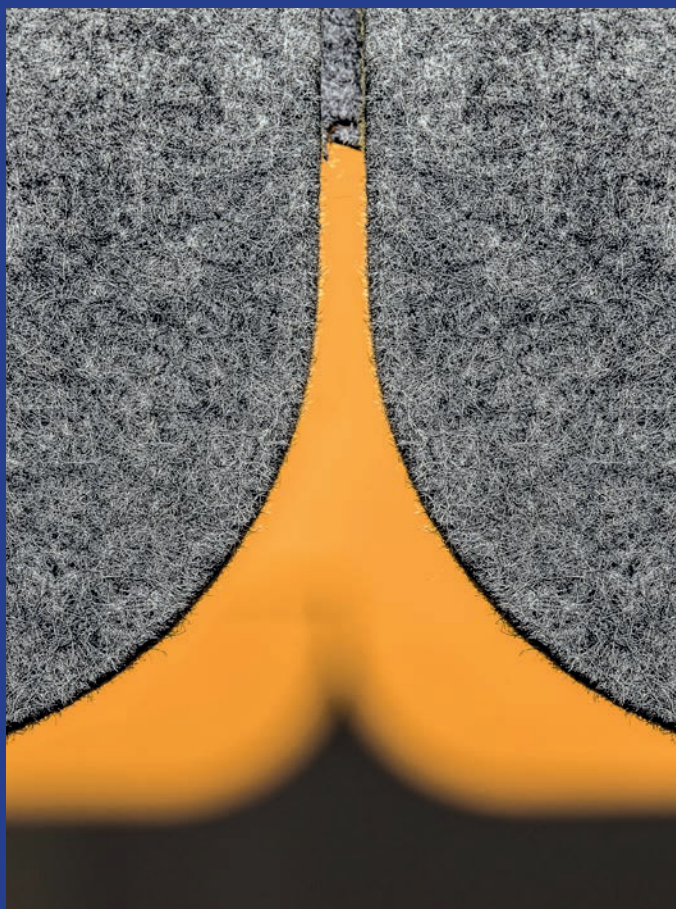



Restaurant



Office

Beam Angle

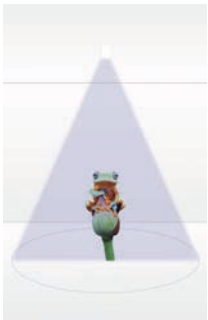

90°

MUTE ø80 24W

incl. DIM 50.000hs L90 / B10 MacAdam 3 100-240V 50 / 60Hz 850°C UGR <19

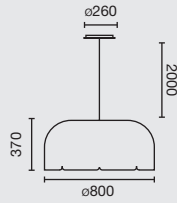

Reference	Finish	Power	Color T	Control System
20101	Dark grey+grey	24W	3000K CRI>80	DA 
20102	Dark grey+brown	24W	3000K CRI>80	ON/OFF
20103	Dark grey+grey	24W	4000K CRI>80	
20104	Dark grey+brown	24W	4000K CRI>80	

20101

DA

Example **20101DA** — Mute ø80 24W 3000K CRI>80 Dark Grey+grey Dali

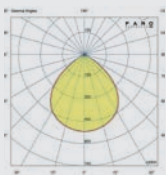

90°

Option	Color T	CRI	Power	Lumen Output	Beam Angle
20101	3000K	>80	24W	1014lm	90°
20102	3000K	>80	24W	1014lm	90°
20103	4000K	>80	24W	1044lm	90°
20104	4000K	>80	24W	1044lm	90°



FOST PENDANT is a tubular shaped suspended light fixture with a proportion designed to be part of the architecture by providing an aesthetic value and accentuating what needs to be highlighted. Its technical and decorative character, and its multiple options of size, optics, color temperatures and CRI make it an ideal option for architectural spaces like restaurants, hotels and other spaces where it is necessary to combine aesthetic values and technical lighting.

FOST PENDANT es una luminaria suspendida de forma tubular con una proporción diseñada para formar parte de la arquitectura aportando un valor estético y acentuando lo que debe ser destacado. Su carácter técnico-decorativo y sus múltiples opciones tanto en tamaños, ópticas, temperaturas de color y IRC, lo convierten en una opción ideal para espacios arquitectónicos como restaurantes, hoteles y otros espacios donde es necesario conjugar valores estéticos e iluminación técnica.





FOOST

S U S P E N D E D



FOST Collection



Track
41



Recessed
223



Pulldown
231



Surface
333



Ceiling
343

MODULE
Modulo

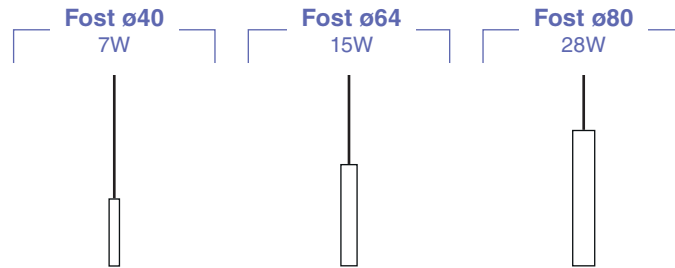

FINISH
Acabado



COLOR TEMPERATURE
Temperatura de color

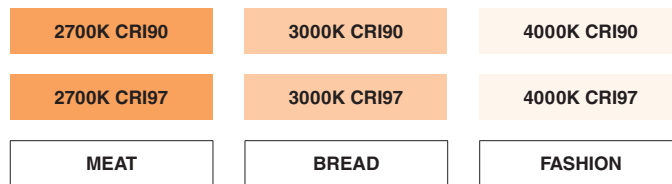

BEAM ANGLE
Ángulo de apertura

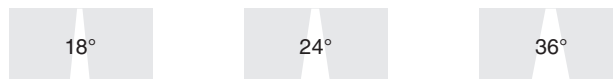

ACCESSORIES
Accesorios



CONTROL SYSTEM
Sistema de control





White Ring
Anillo Blanco



Copper Ring
Anillo Cobre

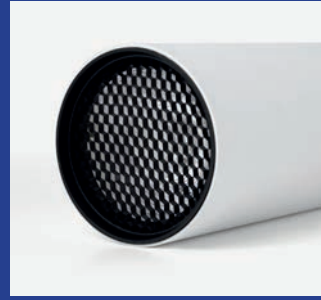

Honeycomb
Panal de Abeja

Its multiple accessories and combinations facilitate the personalisation of the product, giving it certain architectural relevance and at the same time making it possible to modify the beam or reduce glare.

Sus múltiples accesorios y combinaciones facilitan la personalización del producto que hace posible la modificación de haz o reducir el deslumbramiento.

Accessories

	Honeycomb	White Ring	Copper Ring
ø40	-	011500099	011500098
ø64	011700094	011700099	011700098
ø80	011300097	011300099	011300098



Restaurant

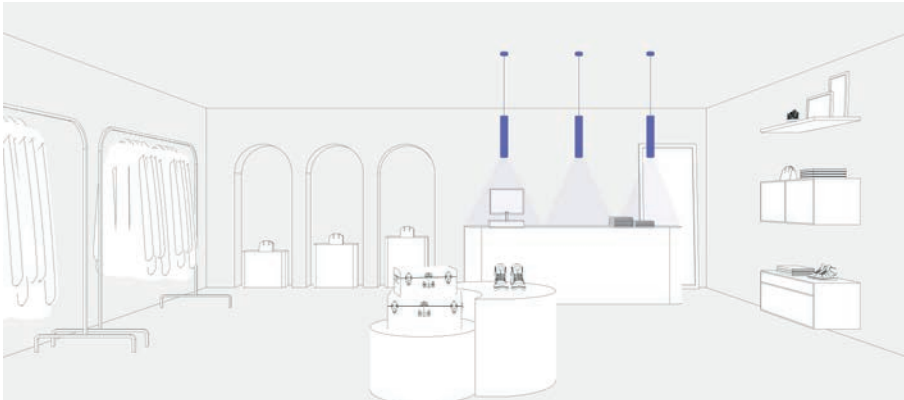

Retail

Beam Angle

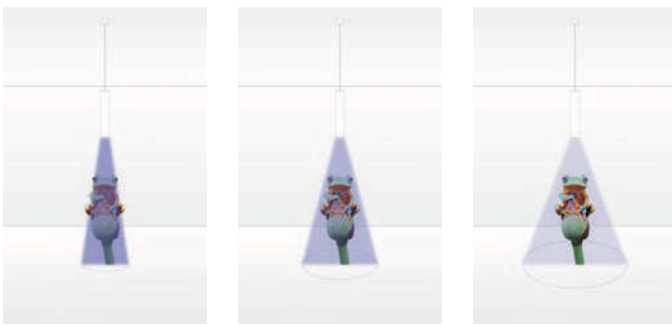

18°

24°

36°

FOST PENDANT ø40

incl. 50.000hs L80 / B10 MacAdam 2 & 3 220-240V 50 / 60Hz 650°C



Family	Color T	Beam Angle	Finish	Control System
0411 Fost Pendant ø40 7W	927 2700K CRI90	1 18°	1 White	D ON/OFF
	930 3000K CRI90	2 24°	2 Black	
	940 4000K CRI90	3 36°		
	X27 2700K CRI97			
	X30 3000K CRI97			
	X40 4000K CRI97			

0411 927 1 1 D

Example **041192711D** — Fost Pendant ø40 7W 2700K CRI90 18° White Dali

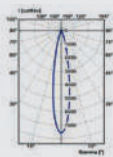

18°

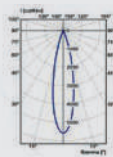

24°

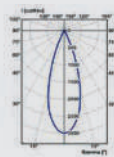

36°

Option	Color T	CRI	Power	Lumen Output	Beam Angle
927	2700K	90	7W	632lm / 553lm / 586lm	18° / 24° / 36°
X27		97	7W	569lm / 498lm / 527lm	
930	3000K	90	7W	652lm / 570lm / 604lm	
X30		97	7W	587lm / 513lm / 544lm	
940	4000K	90	7W	652lm / 587lm / 622lm	18° / 24° / 36°
X40		97	7W	587lm / 528lm / 560lm	

FOST PENDANT ø64

incl. DIM 50.000hs L80 / B10 MacAdam 2 & 3 220-240V 50 / 60Hz 650°C

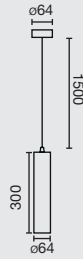

Family	Color T	Beam Angle	Finish	Control System
0412 Fost Pendant ø64 14W	927 2700K CRI90	1 18°	1 White	D DALI
	930 3000K CRI90	2 24°	2 Black	C TRIAC
	940 4000K CRI90	3 36°		ON/OFF
	X27 2700K CRI97			
	X30 3000K CRI97			
	X40 4000K CRI97			

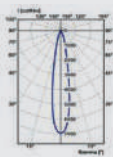

18°

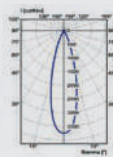

24°



36°

Option	Color T	CRI	Power	Lumen Output	Beam Angle
927	2700K	90	14W	1372lm / 1553lm / 1503lm	18° / 24° / 36°
X27		97	14W	1235lm / 1398lm / 1352lm	18° / 24° / 36°
930	3000K	90	14W	1414lm / 1601lm / 1549lm	18° / 24° / 36°
X30		97	14W	1273lm / 1441lm / 1394lm	18° / 24° / 36°
940	4000K	90	14W	1457lm / 1650lm / 1596lm	18° / 24° / 36°
X40		97	14W	1311lm / 1484lm / 1436lm	18° / 24° / 36°

FOST PENDANT ø80

incl. DIM 50.000hs L70 / B10 MacAdam 2 & 3 220-240V 50 / 60Hz 650°C

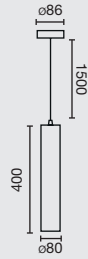

Family	Color T	Beam Angle	Finish	Control System
0413 Fost Pendant ø80 28W	927 2700K CRI90	1 18°	1 White	D DALI
	930 3000K CRI90	2 24°	2 Black	C TRIAC
	940 4000K CRI90	3 36°		ON/OFF
	X27 2700K CRI97			
	X30 3000K CRI97			
	X40 4000K CRI97			

0413 927 1 1 D

Example **041392711D** — Fost Pendant ø80 28W 2700K CRI90 18° White Dali

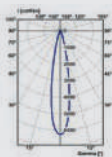

18°

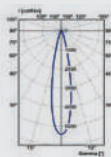

24°

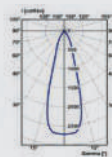

36°

Option	Color T	CRI	Power	Lumen Output	Beam Angle
927	2700K	90	28W	1684lm / 1772lm / 1334lm	18° / 24° / 38°
X27		97	28W	1515lm / 1595lm / 1200lm	18° / 24° / 38°
930	3000K	90	28W	1736lm / 1827lm / 1375lm	18° / 24° / 38°
X30		97	28W	1562lm / 1644lm / 1237m	18° / 24° / 38°
940	4000K	90	28W	1788lm / 1882lm / 1416lm	18° / 24° / 38°
X40		97	28W	1609lm / 1693lm / 1274lm	18° / 24° / 38°



S Y S T

E M S



The LUVA linear lighting system is perfect for offices, thanks to its ultra-slim, efficient, and versatile design. It integrates discreetly into any space, providing uniform and comfortable lighting with UGR optics that reduce glare.

Available in various mounting options, LUVA allows the creation of continuous, uninterrupted light lines. Its point-to-point control, compatible with DALI and CASAMBI, ensures adaptable lighting that meets the needs of any work environment.

El sistema de iluminación lineal LUVA es perfecto para oficinas, gracias a su diseño ultradelgado, eficiente y versátil. Se integra discretamente en cualquier espacio, proporcionando una iluminación uniforme y confortable con ópticas UGR que minimizan el deslumbramiento.

Disponibile en varias opciones de montaje, LUVA permite crear líneas de luz continuas y sin interrupciones. Su control punto a punto, compatible con DALI y CASAMBI, asegura una iluminación adaptable a las necesidades de cada entorno de trabajo.

LUNA

NEW





MODULE
Modulo

Surface
Recessed
Pendant



560



840



1120

LIGHT DIRECTION
Dirección de la luz

SURFACE
Superficie

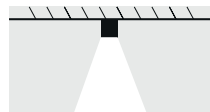

RECESSED
Empotrable

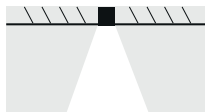

PENDANT
Suspensión

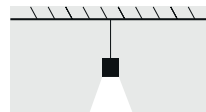

FINISH
Acabado

● **Black**
Negro

○ **White**
Blanco

COLOR TEMPERATURE
Temperatura de color

3000K CRI80

4000K CRI80

DIFFUSER
Difusor



Opal



UGR

CONTROL SYSTEM
Sistema de Control



CASAMBI

Highlights

10 meters with 1 Power Supply

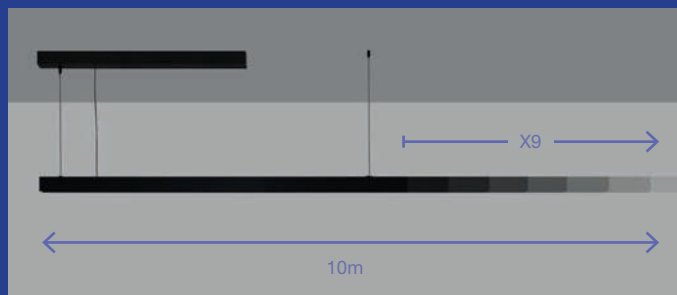

With a single electrical point, up to 10 meters of linear profile can be powered, simplifying installation, reducing costs, and ensuring maximum efficiency in projects

Con un único punto eléctrico se puede alimentar hasta 10 metros de perfil lineal, simplificando la instalación, reduciendo costes y garantizando máxima eficiencia en los proyectos.

Point2Point Control

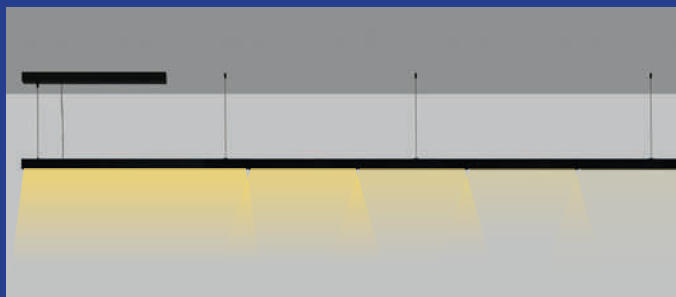

Each LUVA profile can be independently regulated, adjusting light levels as required. This enables personalized, flexible, and dynamic lighting atmospheres with precise control over every section.

Cada perfil LUVA puede regularse de forma independiente, ajustando intensidades de luz según necesidad. Esto permite crear ambientes personalizados, flexibles y dinámicos con precisión absoluta en cada tramo.



Slim Design
Diseño Delgado

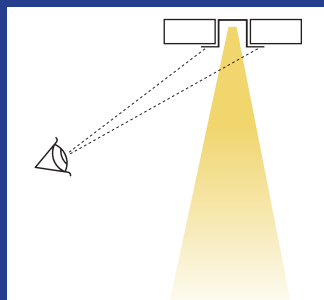

UGR < 19



Connectivity
Conectividad



Suspension

Suspension Power Supply

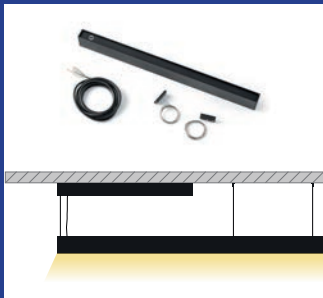

Power supply included / Incluye fuente de alimentación.
Cable / cable (2m).
2 tensioners / 2 tensores (2m/und).
Surface canopy / Florón de superficie.
Compatible with / Compatible con: On/Off, DALI, CASAMBI

Complete kit for a single luminaire.
For multi-piece systems, add an extra tensioner for every 2 meters.
 Kit completo para una luminaria. En sistemas de varias piezas, añadir un tensor extra por cada 2 metros.

The canopy conceals the power supply when remote installation is not possible.
 El florón oculta la fuente de alimentación si no es posible una instalación remota.

Suspension Wire Kit



1 steel tensioner / 1 tensor de acero.
Electrical cable not included / No incluye cable eléctrico.

Additional tensioner for systems with more than one connected piece. Add 1 tensioner for every 2 linear meters.
 Tensor adicional para sistemas con más de una pieza unida. Añadir 1 tensor por cada 2 metros lineales.

Recessed

Recessed Power Supply

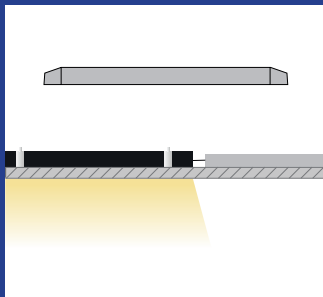

Luva Vision / Deco is a 48V system.
All luminaires, On/Off, DALI, or Casambi, use the same on/off driver.

Luva Vision / Deco es un sistema a 48V. Todas las luminarias On/Off, DALI o Casambi van con la misma fuente On/Off.

Trimless Recessed Kit



Driver required, not included / Requiere driver, no incluido.
3 trimless supports / 3 soportes sin marco.
1 plastic cover / 1 tapa plástico (1,2m)
Compatible with / Compatible con: On/Off, DALI, CASAMBI.

Converts any profile into a trimless recessed version. One kit per connected profile.
 Convierte cualquier perfil en empotrable sin marco. Un kit por cada perfil unido.

Surface

Surface Power Supply



Power supply included / Incluye fuente de alimentación.
Canopy / Florón.
Mechanical connector / Conector mecánico.
Compatible with / Compatible con: On/Off, DALI, CASAMBI.

Allows the power supply to be concealed when installing the linear system on the surface, where no remote location is available to hide it.
 Permite ocultar la fuente de alimentación cuando se instala el sistema lineal en superficie, y no se dispone de una ubicación remota para ocultarla.



Mechanical Connector

Internal mechanical joint for assembling linear profiles.
 Unión mecánica interna para ensamblar perfiles lineales.

*Compatible with all profiles: Suspension, Recessed & Surface
 Compatible para todos los perfiles: Suspensión, Empotrado y Superficie

Accessories

Suspension Power Supply	Recessed Power Supply	Surface Power Supply	Suspension Wire Kit	Trimless Recessed Kit	Mechanical Connector
● 0440100314	98348150	0440100316	● 0440100305	0440100312	
● 0440100315		0440100317	● 0440100306	0440100313	0440100309



Office



Office



Opal

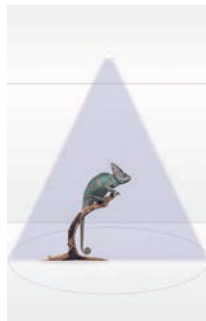

110°



UGR

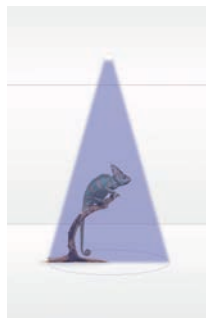

65°

LUVA DECO 560 NEW

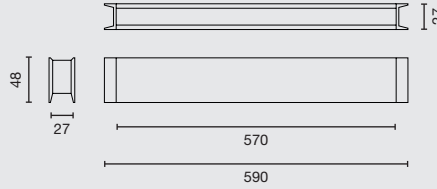

Family	Power	Color T	Finish	Control System
0441 Luva Deco	1 6W	930 3000K CRI90 940 4000K CRI90	1 White 2 Black	W CASAMBI D DALI ON/OFF

0441 1 930 1 W

Example **044119301** — Luva Deco 560mm 6W 3000K CRI90 White

*Requires accessories for recessed and pendant installation. Requires power supply.
 *Requiere de accesorios para empotrable y colgante. Requiere de fuente de alimentación.

LUVA DECO 840 NEW

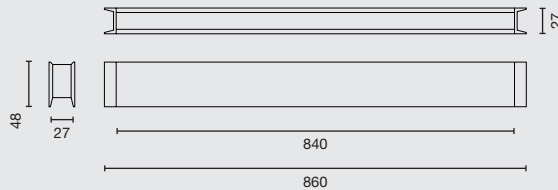

Family	Power	Color T	Finish	Control System
0441 Luva Deco	2 9W	930 3000K CRI90 940 4000K CRI90	1 White 2 Black	W CASAMBI D DALI ON/OFF

*Requires accessories for recessed and pendant installation. Requires power supply.
 *Requiere de accesorios para empotrable y colgante. Requiere de fuente de alimentación.

LUVA DECO 1120

NEW

incl. DIM 50.000hs L80 / B10 MacAdam 3 48V 650°C

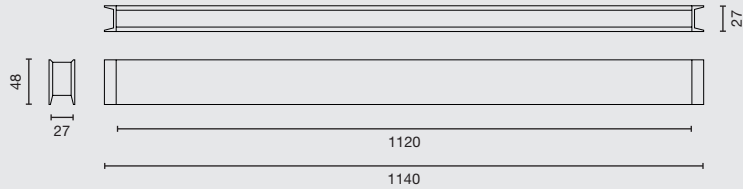

Family	Power	Color T	Finish	Control System
0441 Luva Deco	3 12W	930 3000K CRI90 940 4000K CRI90	1 White 2 Black	W CASAMBI D DALI ON/OFF

*Requires accessories for recessed and pendant installation. Requires power supply.
*Requiere de accesorios para empotrable y colgante. Requiere de fuente de alimentación.

L-SHAPE WITH LIGHT

NEW

incl. DIM 50.000hs L80 / B10 MacAdam 3 48V 650°C

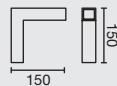

Family	Power	Color T	Finish	Control System
0441 L-shape with light	4 6W	930 3000K CRI90 940 4000K CRI90	1 White 2 Black	W CASAMBI D DALI ON/OFF

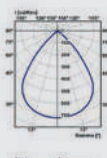

110°

LUVA VISION 560

NEW

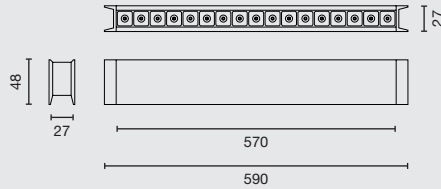

Family	Power	Color T	Finish	Control System
0440 Luvu Vision	1 8W	930 3000K CRI90 940 4000K CRI90	1 White 2 Black	W CASAMBI D BALI ON/OFF

0440 1 930 1 W

Example **044019301W** — Luvu Vision 570mm 8W 3000K CRI90 White

*Requires accessories for recessed and pendant installation. Requires power supply.
*Requiere de accesorios para empotrable y colgante. Requiere de fuente de alimentación.

LUVA VISION 840

NEW

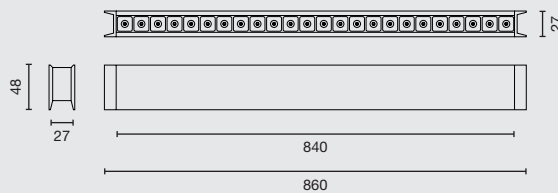

Family	Power	Color T	Finish	Control System
0440 Luvu Vision	2 12W	930 3000K CRI90 940 4000K CRI90	1 White 2 Black	W CASAMBI D BALI ON/OFF

*Requires accessories for recessed and pendant installation. Requires power supply.
*Requiere de accesorios para empotrable y colgante. Requiere de fuente de alimentación.

LUVA VISION 1120

NEW

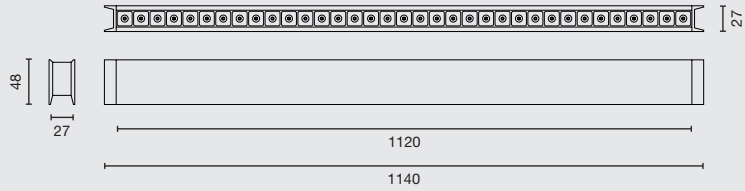

Family	Power	Color T	Finish	Control System
0440 Luva Vision	3 16W	930 3000K CRI90 940 4000K CRI90	1 White 2 Black	W CASAMBI D DALI ON/OFF

*Requires accessories for recessed and pendant installation. Requires power supply.
 *Requiere de accesorios para empotrable y colgante. Requiere de fuente de alimentación.

L-SHAPE WITHOUT LIGHT

NEW

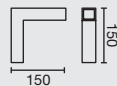

●	0440100110	Luva vision L-SHAPE without light black
●	0440100111	Luva vision L-SHAPE without light white

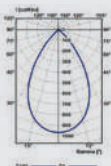

65°

LUVA VISION PENDANT 1140



incl. DIM 50.000hs L80 / B10 MacAdam 3 220-240V 650°C UGR <19

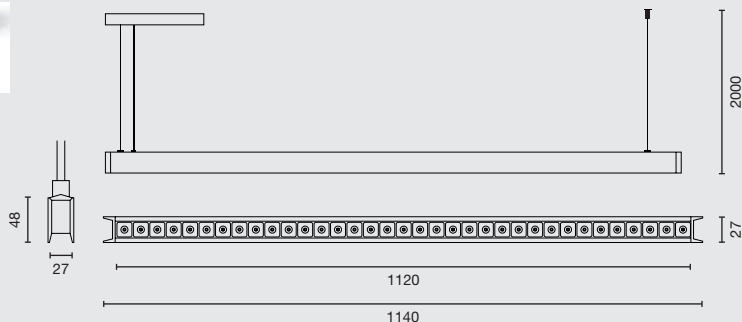

Family	Power	Color T	Finish	Control System
0442 Luva Vision Pendant	4 16W	930 3000K CRI90 940 4000K CRI90	1 White 2 Black	W CASAMBI D BALI ON/OFF

0442 **4** **930** **1** **W**

Example **044249301W** — Luva Vision Pendant 1120mm 16W 3000K CRI90 White Casambi

*Includes hanging accessories, finial, and driver.
 *Incluye accesorios colgantes, florón y driver.

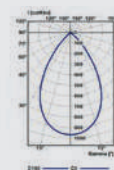

65°

LUVA VISION

Option	Color T	CRI	Difusor	Power	Lumen Output	Beam Angle
560	3000K	90	UGR	8W	700	65°
	4000K	90	UGR	8W	720	65°
840	3000K	90	UGR	12W	1044	65°
	4000K	90	UGR	12W	1075	65°
1120	3000K	90	UGR	16W	1376	65°
	4000K	90	UGR	16W	1418	65°

LUVA VISION PENDANT

Option	Color T	CRI	Difusor	Power	Lumen Output	Beam Angle
1120	3000K	90	UGR	16W	1376	65°
	4000K	90	UGR	16W	1418	65°

LUVA DECO

Option	Color T	CRI	Difusor	Power	Lumen Output	Beam Angle
560	3000K	90	Opal	6W	447	110°
	4000K	90	Opal	6W	460	110°
850	3000K	90	Opal	9W	670	110°
	4000K	90	Opal	9W	690	110°
1120	3000K	90	Opal	12W	894	110°
	4000K	90	Opal	12W	920	110°



NESO, a magnetic track system, seamlessly integrates various luminaires, ranging from general lights to striking accents. Its modular and magnetic design not only provides flexibility but also transforms environments with its exceptional adaptability and design. Ideal for commercial settings, NESO offers projectors with up to 20W, whereas NESO Slim, tailored for residential spaces, brings elegance and an endless array of options to craft truly unique atmospheres.

NESO, un sistema de carril magnético, fusiona distintas luminarias, abarcando desde luces generales hasta resaltantes acentos. Su diseño modular y magnético no solo brinda flexibilidad, sino que también transforma entornos con su adaptabilidad y diseño excepcional. Perfecto para entornos comerciales, NESO ofrece proyectores de hasta 20W, mientras que NESO Slim, diseñado para espacios residenciales, aporta elegancia y una variedad ilimitada de opciones para crear ambientes verdaderamente únicos.



THE MAGNETIC TRACK SYSTEM

NESO



New Configurator

Unlimited creativity



Discover



TRACKS
Carriles

RECESSED
Empotrable



1000 | 2000

SURFACE
Superficie

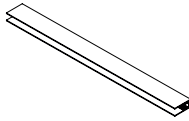

1000 | 2000

PENDANT
Colgante

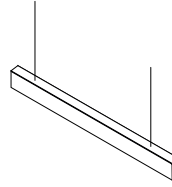

1000 | 2000

MODULES
Módulos

Neso
Point



84



164



320

Neso
Unik



ø150



ø150

Neso
Line

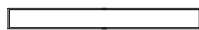

320

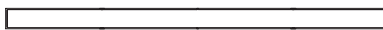

640

Neso
Hole

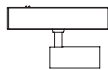

ø35

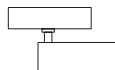

ø50

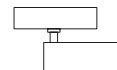

ø70

Neso
Top



ø35

FINISH
Acabado

● **Black**
Negro

○ **White**
Blanco

COLOR TEMPERATURE
Temperatura de color

2700K CRI>90

3000K CRI>90

CONTROL SYSTEM
Sistema de Control



CASAMBI

Highlights

Neso Slim



Super Slim Design
Diseño Super Delgado



Maximum Integration of luminaires on rail
Integración máxima de las luminarias en carril

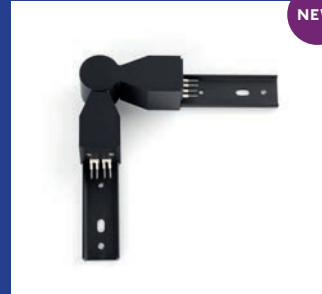

Variable Corner $\pm 90^\circ$
Esquina variable $\pm 90^\circ$

Neso Slim and Standard

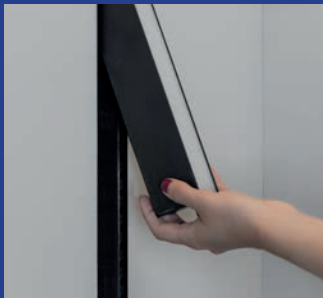

Magnetic
Magnético

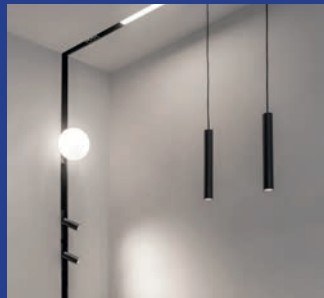

Versatility
Versatilidad

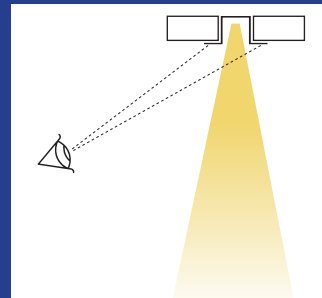

UGR < 16 Option



Connectivity
Conectividad



Honeycomb
Nido de Abeja

Accessories

Honeycomb

5010PP0049	Neso Hole $\varnothing 35\text{mm}$
5010PP0050	Neso Hole $\varnothing 50\text{mm}$

N

Honeycomb

5010PP0049	Neso Slim Hole $\varnothing 35\text{mm}$
5010PP0050	Neso Slim Hole $\varnothing 50\text{mm}$

N



TRACK RECESSED

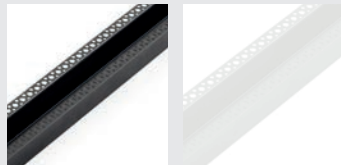
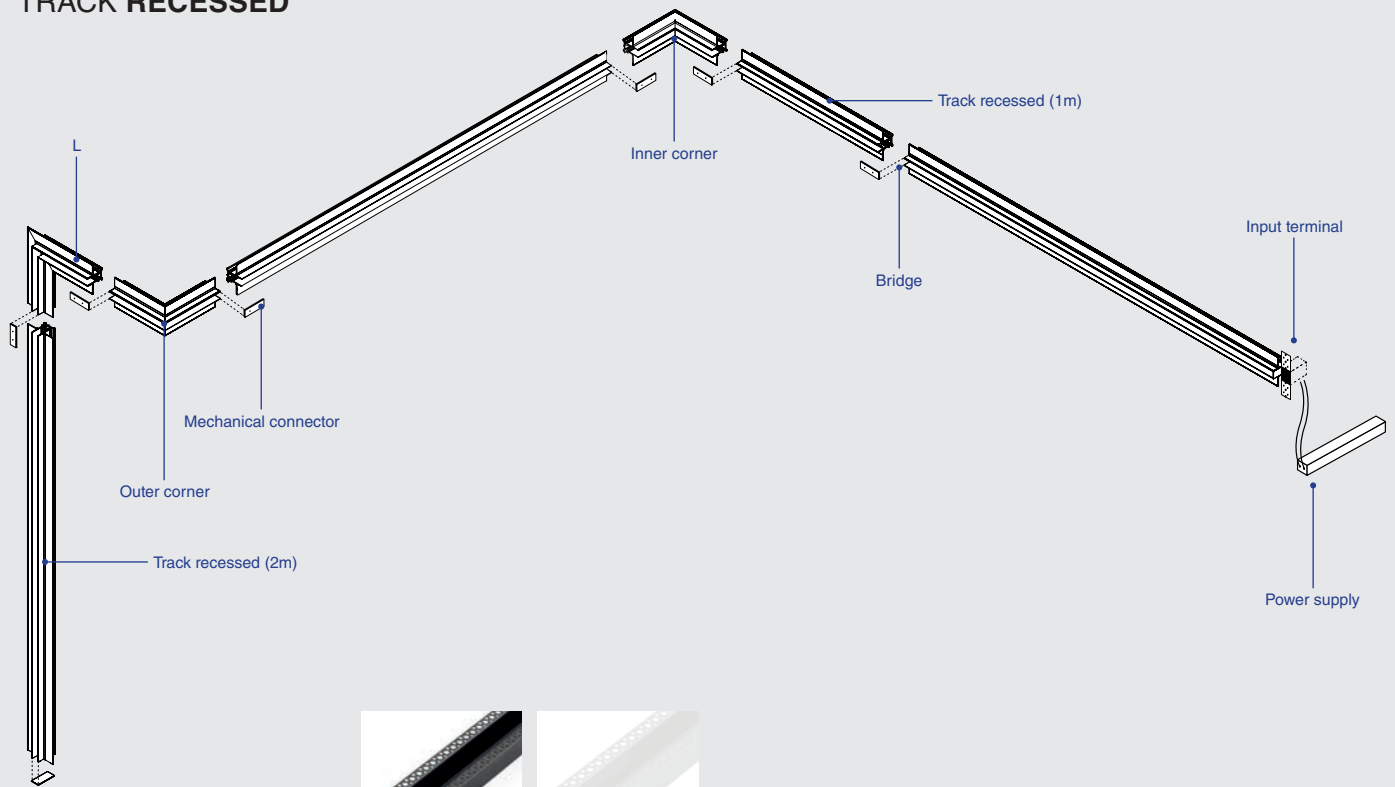

24V

Family **Track Length** **Finish** **Control System**

5020120	Neso Track Recessed	10	1m	1	White	D	 ON/OFF
		20	2m	2	Black		

ACCESSORIES NESO

	● 5020200102	Mechanical connector		● 5020221401 / ● 5020221402	Input terminal
	● 5020115101 / ● 5020115102	Bridge		● 5020221401D / ● 5020221402D	Input terminal DALI
	● 5020115101D / ● 5020115102D	Bridge DALI		● 5020221001 / ● 5020221002	L
● 5020R120102	Track cover		● 5020221001D / ● 5020221002D	L DALI	
● 5020R120101	Track cover		● 5020221101 / ● 5020221102	T	
POWER SUPPLY			● 5020221101D / ● 5020221102D	T DALI	
98324061	Power supply 60W		● 5020221201 / ● 5020221202	Inner corner	
98324099	Power supply 100W		● 5020221201D / ● 5020221202D	Inner corner DALI	
98324150	Power supply 150W		● 5020221301 / ● 5020221302	Outer corner	
98324200	Power supply 200W		● 5020221301D / ● 5020221302D	Outer corner DALI	

TRACK SURFACE & SUSPENSION

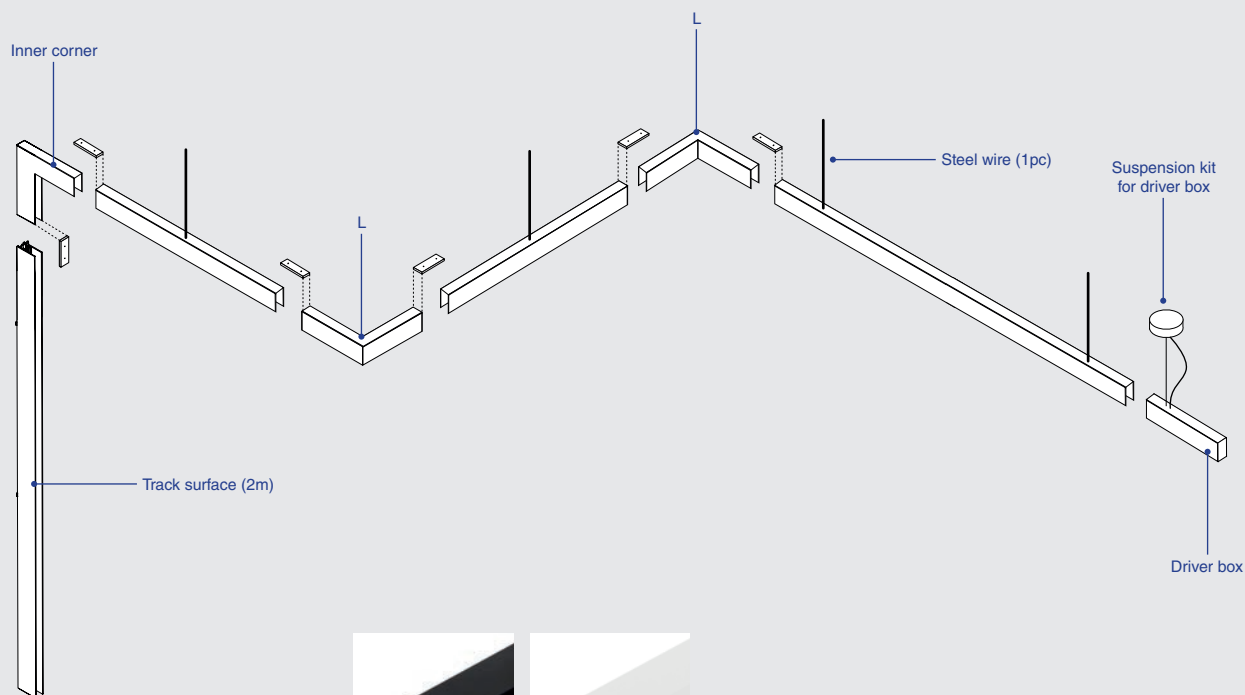

24V

Family **Track Length** **Finish** **Control System**

5020110	Neso Track Surface	10	1m	1	White	D	
		20	2m	2	Black		ON/OFF

ACCESSORIES NESO

	● 5020200102	Mechanical connector		● 5020210301 / ● 5020210302	Input terminal
	● 5020115101 / ● 5020115102	Bridge		● 5020210301D / ● 5020210302D	Input terminal DALI
	● 5020115101D / ● 5020115102D	Bridge DALI		● 5020211001 / ● 5020211002	L
	● 5020210001 / ● 5020210002	Driver box		● 5020211001D / ● 5020211002D	L DALI
	● 5020210001D / ● 5020210002D	Driver box DALI		● 5020211101 / ● 5020211102	T
	● 5020210201 / ● 5020210202	Suspension kit		● 5020211101D / ● 5020211102D	T DALI
	● 5020210201D / ● 5020210202D	Suspension kit DALI		● 5020211201 / ● 5020211202	Inner corner
	5020210102	Steel wire		● 5020211201D / ● 5020211202D	Inner corner DALI
	● 5020R120102	Track cover		● 5020211301 / ● 5020211302	Outer corner
	● 5020R120101	Track cover		● 5020211301D / ● 5020211302D	Outer corner DALI
POWER SUPPLY					
98324061	Power supply 60W				
98324099	Power supply 100W				
98324150	Power supply 150W				
98324200	Power supply 200W				

NESO POINT 3L

no incl. 50.000hs L70/B10  MacAdam 3 24V  650°C  UGR <16

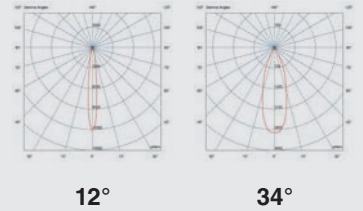
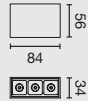

Family	Color T	Beam Angle	Finish
50101 Point 3L 4W	927 2700K 217lm CRI>90	1 12°	1 White
	930 3000K 292lm CRI>90	2 34°	2 Black

NESO POINT 6L

no incl. 50.000hs L70/B10  MacAdam 3 24V  650°C  UGR <16

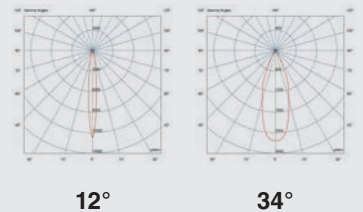
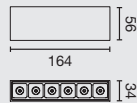

Family	Color T	Beam Angle	Finish	Control System
50102 Point 6L 8W	927 2700K 480lm CRI>90	1 12°	1 White	W CASAMBI
	930 3000K 506lm CRI>90	2 34°	2 Black	D DALI
				ON/OFF

NESO POINT 12L

no incl. 50.000hs L70/B10  MacAdam 3 24V  650°C  UGR <16

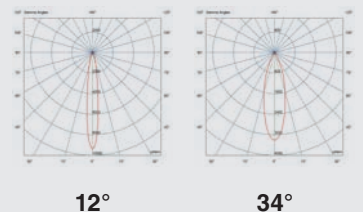
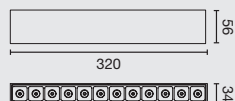

Family	Color T	Beam Angle	Finish	Control System
50103 Point 12L 16W	927 2700K 1102lm CRI>90	1 12°	1 White	W CASAMBI
	930 3000K 1107lm CRI>90	2 34°	2 Black	D DALI
				ON/OFF



NESO LINE 32cm

no incl. 50.000hs L70/B10   MacAdam 3 24V  650°C

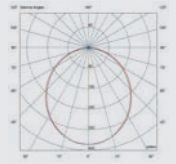
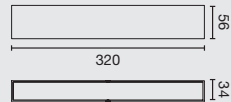

32

Family

Color T

Finish

Control System

50104 Line 32cm 13W

927 2700K 892lm CRI>90

01 White

W CASAMBI

930 3000K 920lm CRI>90

02 Black

D DALI

ON/OFF

NESO LINE 64cm

no incl. 50.000hs L70/B10   MacAdam 3 24V  650°C

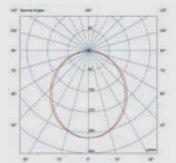
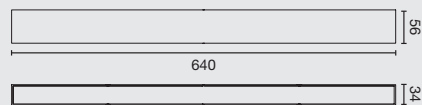

64

Family

Color T

Finish

Control System

50105 Line 64cm 26W

927 2700K 1399lm CRI>90

01 White

W CASAMBI

930 3000K 1442lm CRI>90

02 Black

D DALI

ON/OFF



NESO HOLE ø3.5cm

no incl. 50.000hs L90/B10 MacAdam 3 24V 650°C

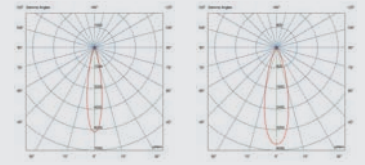
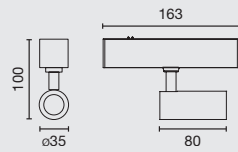

20°

40°

Family **Color T** **Beam Angle** **Finish** **Control System**

50107 Hole ø3,5cm 5W

927 2700K 360lm CRI>90

930 3000K 444lm CRI>90

1 20°

2 40°

1 White

2 Black

W CASAMBI

D DALI

ON/OFF

NESO HOLE ø5cm

no incl. 50.000hs L90/B10 MacAdam 3 24V 650°C

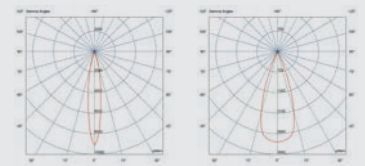
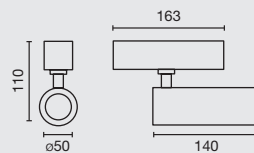

18°

36°

Family **Color T** **Beam Angle** **Finish** **Control System**

50108 Hole ø5cm 10W

027 2700K 445lm CRI>90

030 3000K 592lm CRI>90

1 18°

2 36°

1 White

2 Black

W CASAMBI

D DALI

ON/OFF

NESO HOLE ø7cm

no incl. 50.000hs L90/B10 MacAdam 3 24V 650°C

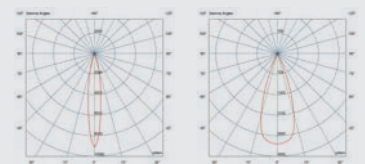
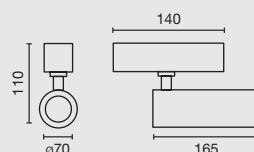

18°

36°

Family **Color T** **Beam Angle** **Finish** **Control System**

50110 Hole ø7cm 20W

027 2700K 881lm CRI90

030 3000K 1171lm CRI90

1 18°

2 36°

1 White

2 Black

W CASAMBI

D DALI

ON/OFF



NESO UNIK

no incl. 50.000hs L90/B10 III MacAdam 3 24V 650°C

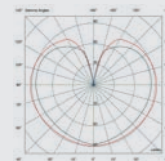
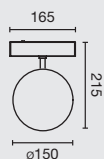

325°

Family

Color T

Finish

Control System

50108 Unik 5W

927 2700K 256lm CRI>90
930 3000K 264lm CRI>90

01 White
02 Black

W CASAMBI
D DALI
ON/OFF

NESO UNIK

no incl. 50.000hs L90/B10 III MacAdam 3 24V 650°C

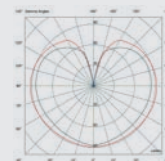
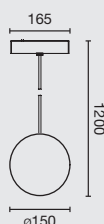

325°

Family

Color T

Finish

Control System

50109 Unik 5W

027 2700K 256lm CRI>90
030 3000K 264lm CRI>90

01 White
02 Black

W CASAMBI
D DALI
ON/OFF

NESO TOP

no incl. 50.000hs L90/B10 III MacAdam 3 24V 650°C

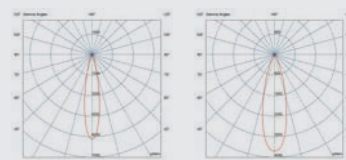
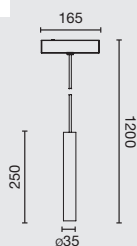

20°

40°

Family

Color T

Beam Angle

Finish

Control System

50106 Top 5W

927 2700K 360m CRI>90
930 3000K 444lm CRI>90

1 20°
2 40°

1 White
2 Black

W CASAMBI
D DALI
ON/OFF



NESO SLIM



TRACKS
Carriles

RECESSED
Empotrable



1000 | 2000

SURFACE
Superficie

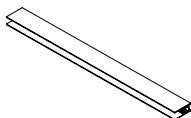

1000 | 2000

PENDANT
Colgante

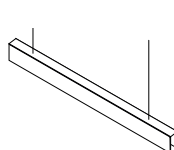

1000 | 2000

MODULES
Módulos

Neso Slim
Point



305



388

Neso Slim
Unik



ø150

Neso Slim
Linse



ø50



ø50

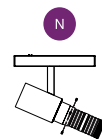

ø50

Neso Slim
Line/Wallwasher



305



704



305

Neso Slim
Hole

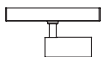

ø35



ø50

Neso Slim
Pendants

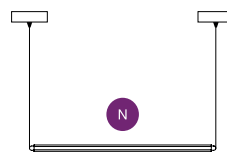

636



936 / 1200

Neso Slim
Pendants

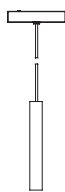

ø35

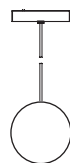

ø150



ø32



ø40



ø72

N



636

N



936

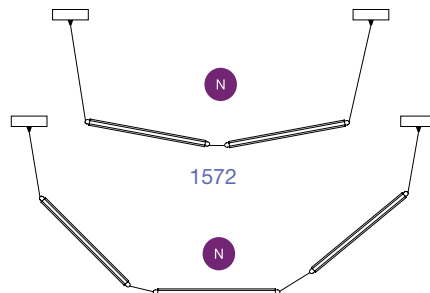

1572

2308

FINISH
Acabado

● **Black**
Negro

COLOR TEMPERATURE
Temperatura de color

2200K CRI>90

2700K CRI>90

3000K CRI>90

4000K CRI>90

CONTROL SYSTEM
Sistema de Control



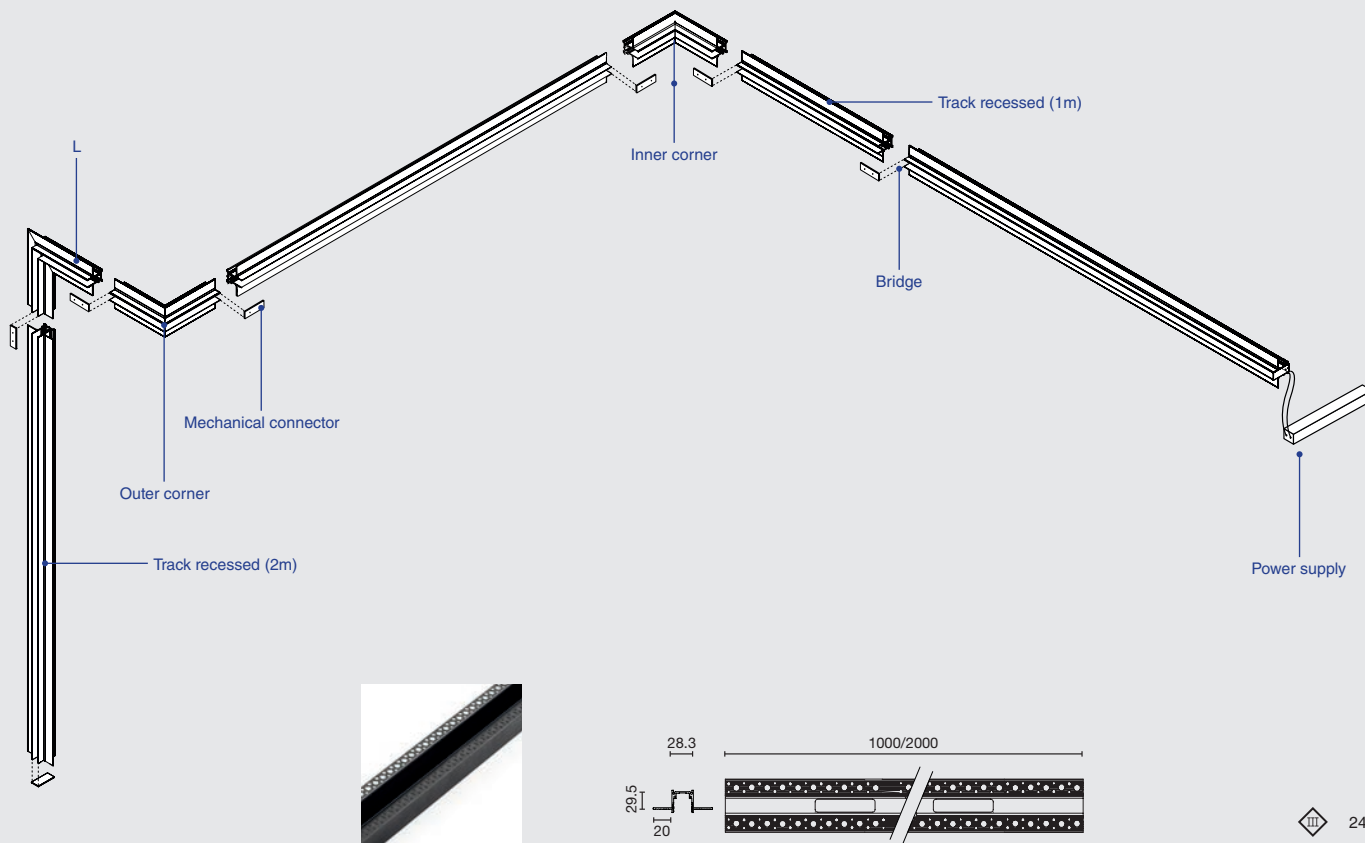

CASAMBI

TRACK RECESSED

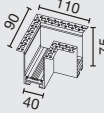
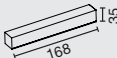
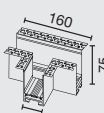
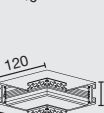
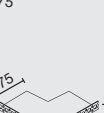

Family	Track Length	Finish	Control System
6020120 Neso Track Recessed	10 1m	2 Black	D ON/OFF
	20 2m		

ACCESSORIES NESO SLIM

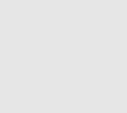
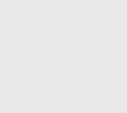
	● 6020200102 Mechanical connector		● 6020221002 L
	● 6020115102 Bridge		● 6020221002D L DALI
	● 6020115102D Bridge DALI		● 6020221102 T
	● 6020R120102 Track cover		● 6020221102D T DALI
POWER SUPPLY			● 6020221202 Inner corner
98324060 Power supply 60W			● 6020221202D Inner corner DALI
98324120 Power supply 120W			● 6020221302 Outer corner
			● 6020221302D Outer corner DALI

TRACK SURFACE & SUSPENSION

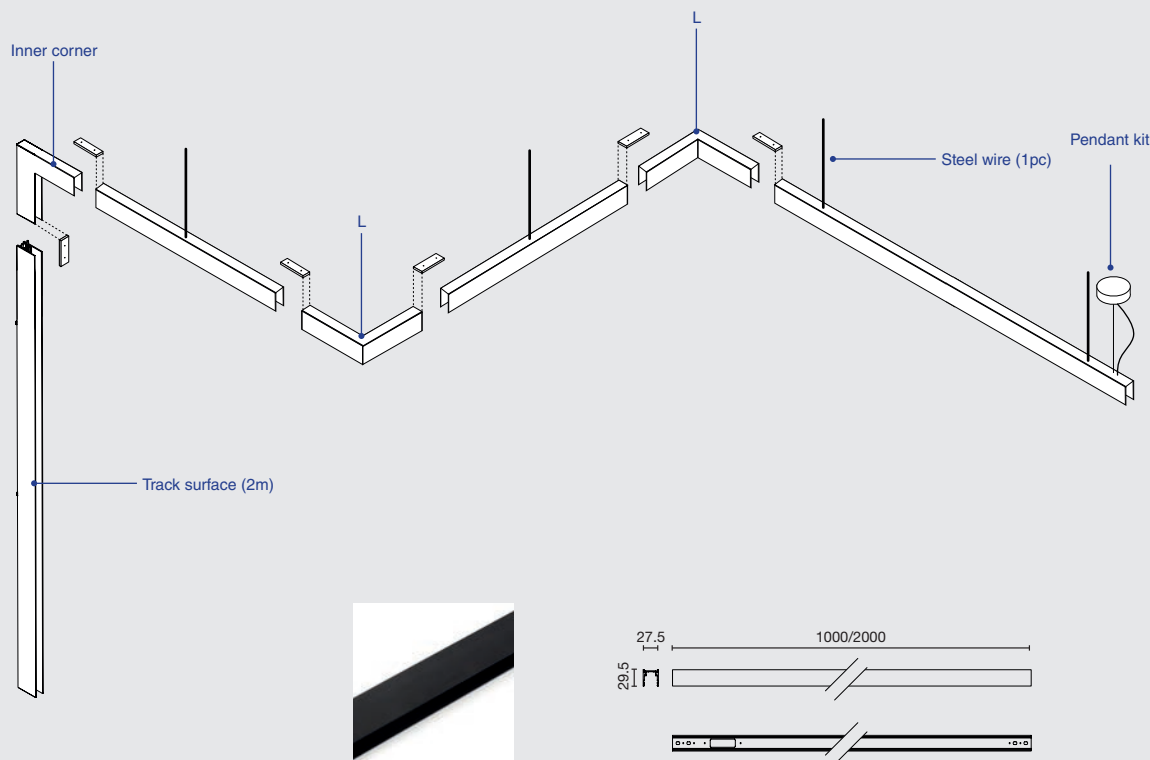

24V

Family	Track Length	Finish	Control System
6020110 Neso Track Surface	10 1m 20 2m	2 Black	D ON/OFF

ACCESSORIES NESO SLIM

	● 6020200102 Mechanical connector
	● 6020200103 Surface mounting Kit
	● 6020210202 Pendant Kit
	● 6020210202D Pendant kit DALI
	6020210102 Steel wire
	6020R120102 Track cover
POWER SUPPLY	
	98324060 Power supply 60W
	98324120 Power supply 120W

	● 6020115102 Bridge
	● 6020115102D Bridge DALI
	● 6020211002 L
	● 6020211002D L DALI
	● 6020211102 T
	● 6020211102D T DALI
	● 6020211202 Inner corner
	● 6020211202D Inner corner DALI
	● 6020211302 Outer corner
	● 6020211302D Outer corner DALI
	● 6020211003 Neso slim L Negro Variable
	● 6020211003D Neso slim L Negro DALI

N

NESO SLIM POINT 12L

no incl. 50.000hs L70/B10   MacAdam 3 24V  650°C  UGR <16

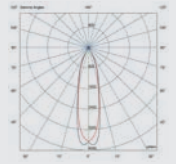
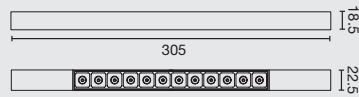

25°

Family	Color T	Beam Angle	Finish	Control System
60102 Point Slim 12L 12W	927 2700K 816lm CRI>90 930 3000K 841lm CRI>90	1 25°	2 Black	W CASAMBI D  ON/OFF

NESO SLIM POINT 24L

no incl. 50.000hs L70/B10   MacAdam 3 24V  650°C  UGR <16

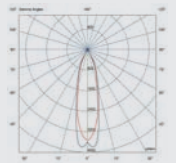

25°

Family	Color T	Beam Angle	Finish	Control System
60103 Point Slim 24L 24W	927 2700K 1674lm CRI>90 930 3000K 1726lm CRI>90	1 25°	2 Black	W CASAMBI D  ON/OFF



NESO SLIM LINE 30cm

no incl. 50.000hs L70/B10   MacAdam 3 24V  650°C

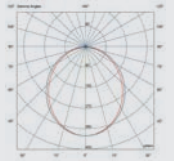
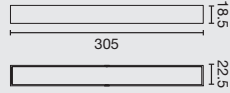

Family

Color T

Finish

Control System

60104 Line Slim 30cm 6W

927 2700K 322lm CRI>90

02 Black

W CASAMBI

930 3000K 332lm CRI>90

D DALI

ON/OFF

NESO SLIM LINE 70cm

no incl. 50.000hs L70/B10   MacAdam 3 24V  650°C

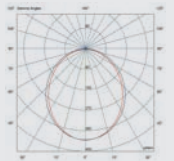
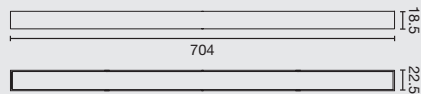

Family

Color T

Finish

Control System

60105 Line Slim 70cm 18W

927 2700K 875lm CRI>90

02 Black

W CASAMBI

930 3000K 902lm CRI>90

D DALI

ON/OFF

NESO SLIM LINE WALL WASHER 30cm

no incl. 50.000hs L70/B10   MacAdam 3 24V  650°C

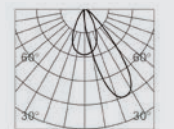
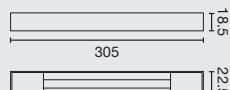

Family

Color T

Finish

Control System

60111 Line Slim wallwasher 30cm 6W

927 2700K 311lm CRI>90

02 Black

W CASAMBI

930 3000K 320lm CRI>90

D DALI

ON/OFF



NESO SLIM HOLE ø3.5cm

no incl. 50.000hs L90/B10 MacAdam 3 24V 650°C

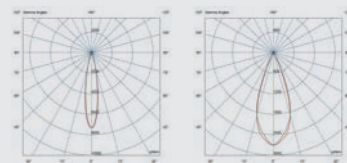
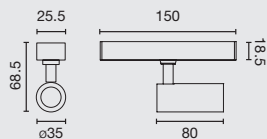

20°

40°

Family

Color T

Beam Angle

Finish

Control System

60107 Hole Slim ø3,5cm 5W

927 2700K 360lm CRI>90

930 3000K 444lm CRI>90

1 20°

2 40°

2 Black

W CASAMBI

D DALI

ON/OFF

NESO SLIM HOLE ø5cm

no incl. 50.000hs L90/B10 MacAdam 3 24V 650°C

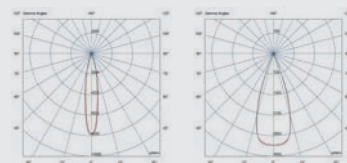
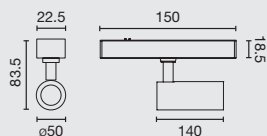

18°

36°

Family

Color T

Beam Angle

Finish

Control System

60108 Hole Slim ø5cm 10W

027 2700K 445lm CRI>90

030 3000K 592lm CRI>90

1 18°

2 36°

2 Black

W CASAMBI

D DALI

ON/OFF



NESO SLIM UNIK

no incl. 50.000hs L90/B10 MacAdam 3 24V 650°C

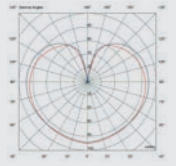
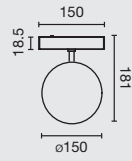

325°

Family

Color T

Finish

Control System

60108 Unik Slim 5W

927 2700K 230lm CRI>90

02 Black

W CASAMBI

930 3000K 237lm CRI>90

D DALI

ON/OFF

NESO SLIM UNIK PENDANT

no incl. 50.000hs L90/B10 MacAdam 3 24V 650°C

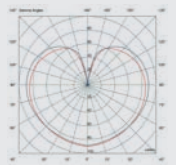
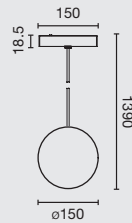

325°

Family

Color T

Finish

Control System

60109 Unik Slim pendant 5W

027 2700K 230lm CRI>90

02 Black

W CASAMBI

030 3000K 237lm CRI>90

D DALI

ON/OFF

NESO SLIM PENDANT

no incl. 50.000hs L90/B10 MacAdam 3 24V 650°C

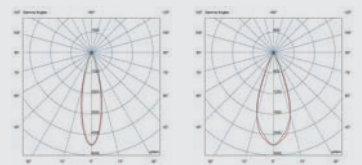
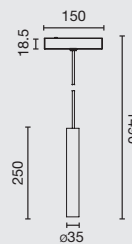

20°

40°

Family

Color T

Beam Angle

Finish

Control System

60106 Neso Slim pendant 5W

927 2700K 308lm CRI>90

1 20°

2 Black

W CASAMBI

930 3000K 320lm CRI>90

2 40°

D DALI

ON/OFF



NESO SLIM ANNA

no incl. 50.000hs L80/B10 MacAdam 3 24V

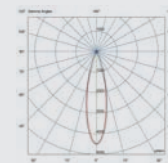
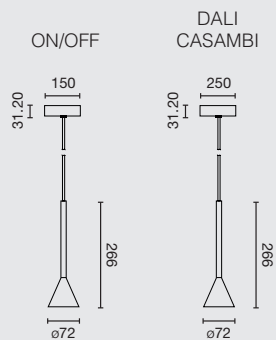

15°

Family **Color T** **Beam Angle** **Finish** **Control System**

60110 Anna Slim pendant 6W

927 2700K CRI90

1 15°

2 Black

W CASAMBI
D
ON/OFF

NESO SLIM DIANA

no incl. 50.000hs L80/B10 MacAdam 3 24V

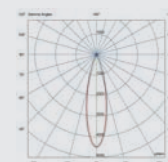
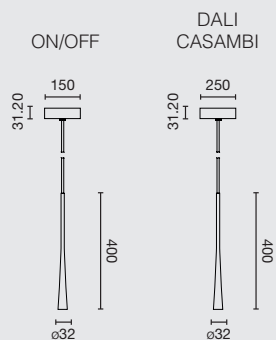

18°

Family **Color T** **Beam Angle** **Finish** **Control System**

60112 Diana Slim 400 6W

927 2700K CRI90

1 18°

2 Black

W CASAMBI
D
ON/OFF

60113 Diana Slim 600 6W

60114 Diana Slim 800 6W

NESO SLIM NINA

no incl. 50.000hs L80/B10 MacAdam 3 24V

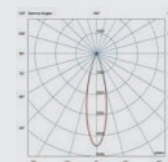
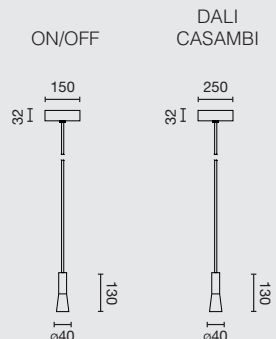

18°

Family **Color T** **Beam Angle** **Finish** **Control System**

60111 Nina Slim 4W

927 2700K CRI90

1 18°

2 Black

W CASAMBI
D
ON/OFF



NESO SLIM LUMINA VERTICAL PENDANT

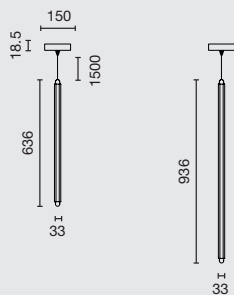

Family	Finish	Color T	Installation	Cristal	Control System
6460 Neso Slim Lumina 600 1L Vertical Pendant 12W	2 Black	1 2200K	4 Neso Slim	1 Transparent	D ON/OFF
6466 Neso Slim Lumina 900 1L Vertical Pendant 18W		2 2700K			

NESO SLIM LUMINA HORIZONTAL PENDANT

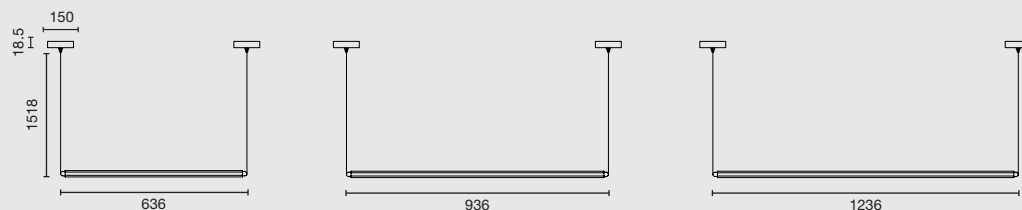

Family	Finish	Color T	Installation	Cristal	Control System
6461 Neso Slim Lumina 600 1L Horizontal Pendant 12W	2 Black	1 2200K	4 Neso Slim	1 Transparent	D ON/OFF
6467 Neso Slim Lumina 900 1L Horizontal Pendant 18W		2 2700K			
6468 Neso Slim Lumina 1200 1L Horizontal Pendant 24W					

NESO SLIM LUMINA VERTICAL / HORIZONTAL PENDANT 600

Option	Color T	CRI	Power	Lumen Output	Beam Angle
1	2200k	90	12W	605lm	-
2	2700k	90		712lm	-

NESO SLIM LUMINA VERTICAL / HORIZONTAL PENDANT 900

Option	Color T	CRI	Power	Lumen Output	Beam Angle
1	2200k	90	18W	946lm	-
2	2700k	90		1113lm	-

NESO SLIM LUMINA HORIZONTAL PENDANT 1200

Option	Color T	CRI	Power	Lumen Output	Beam Angle
1	2200k	90	24W	1287lm	-
2	2700k	90		1514lm	-



NESO SLIM LUMINA SWAG PENDANT 2L



incl. DIM 50.000hs L70/B10 MacAdam 3 24V 650°C

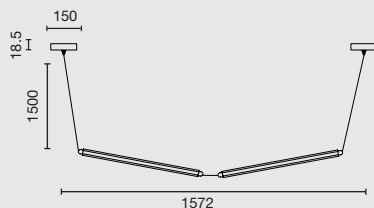

Family **Finish** **Color T** **Installation** **Cristal** **Control System**

6462	Neso Slim Lumina 600 2L Swag Pendant 24W	2 Black	1 2200K 2 2700K	4 Neso Slim	1 Transparent	D ON/OFF
-------------	--	----------------	----------------------------------	--------------------	----------------------	-----------------

NESO SLIM LUMINA SWAG PENDANT 3L



incl. DIM 50.000hs L70/B10 MacAdam 3 24V 650°C

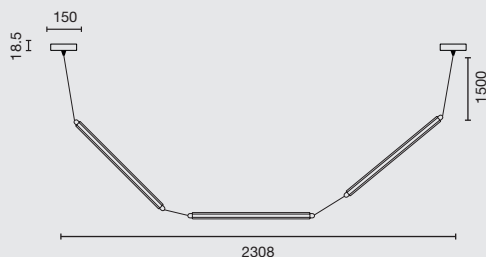

Family **Finish** **Color T** **Installation** **Cristal** **Control System**

6464	Neso Slim Lumina 600 3L Swag Pendant 36W	2 Black	1 2200K 2 2700K	4 Neso Slim	1 Transparent	D ON/OFF
-------------	--	----------------	----------------------------------	--------------------	----------------------	-----------------

*Requires accessories for recessed and pendant installation. Requires power supply.

*Requiere de accesorios para empotrable y colgante. Requiere de fuente de alimentación.

NESO SLIM LUMINA SWAG PENDANT 600 2L

Option	Color T	CRI	Power	Lumen Output	Beam Angle
1	2200k	90	24W	1210lm	-
2	2700k	90		1424lm	-

NESO SLIM LUMINA SWAG PENDANT 600 3L

Option	Color T	CRI	Power	Lumen Output	Beam Angle
1	2200k	90	24W	1815lm	-
2	2700k	90		2136m	-



NESO SLIM LINSE



- incl.
- DIM
- 355°
- 90°
- 50.000hs L70 / B10
- III
- MacAdam 2&3
- 24V
- 650°C

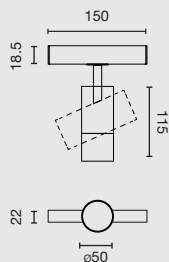

Family	Color T	Beam Angle	Finish	Control System
0392 Nesos Slim Linse	1 10W	1 15°	2 Black	W CASAMBI
	2 20W			
	927 2700K CRI90	2 24°		D DALI
	930 3000K CRI90	3 36°		ON/OFF
	940 4000K CRI90	5 50°		
	T27 2700K THRIVE			
	T30 3000K THRIVE			
	T40 4000K THRIVE			

NESO SLIM LINSE

Option	Color T	CRI	Power	Lumen Output	Beam Angle
927	2700K	90	10W	771 / 968 / 967 / 944	15° / 24° / 36° / 50°
T27		THRIVE	10W	681 / 855 / 854 / 833	15° / 24° / 36° / 50°
930	3000K	90	10W	795 / 998 / 997 / 973	15° / 24° / 36° / 50°
T30		THRIVE	10W	702 / 881 / 880 / 859	15° / 24° / 36° / 50°
940	4000K	90	10W	819 / 1028 / 1027 / 1002	15° / 24° / 36° / 50°
T40		THRIVE	10W	722 / 907 / 906 / 884	15° / 24° / 36° / 50°
927	2700K	90	20W	1309 / 1643 / 1641 / 1602	15° / 24° / 36° / 50°
T27		THRIVE	20W	1154 / 1449 / 1448 / 1414	15° / 24° / 36° / 50°
930	3000K	90	20W	1349 / 1694 / 1692 / 1651	15° / 24° / 36° / 50°
T30		THRIVE	20W	1190 / 1494 / 1492 / 1456	15° / 24° / 36° / 50°
940	4000K	90	20W	1389 / 1745 / 1742 / 1701	15° / 24° / 36° / 50°
T40		THRIVE	20W	1226 / 1539 / 1537 / 1500	15° / 24° / 36° / 50°

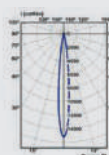

15°

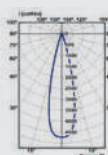

24°

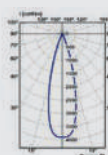

36°



50°

NESO SLIM LINSE ZOOM



- incl.
- DIM
- 355°
- 90°
- 50.000hs
L70 / B10
- III
- MacAdam
2&3
- 24V
- 650°C

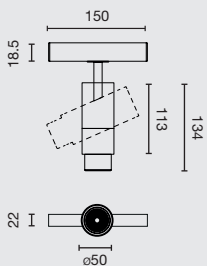

Family	Color T	Beam Angle	Finish	Control System										
0392 Neso Slim Linse Zoom <table border="1" style="margin-left: 20px;"> <tr><td>1</td><td>10W</td></tr> <tr><td>2</td><td>20W</td></tr> </table>	1	10W	2	20W	927 2700K CRI90 930 3000K CRI90 940 4000K CRI90 T27 2700K THRIVE T30 3000K THRIVE T40 4000K THRIVE	6 20° - 50°	2 Black	<table border="1" style="margin-left: 20px;"> <tr><td>W</td><td>CASAMBI</td></tr> <tr><td>D</td><td>BALI</td></tr> <tr><td></td><td>ON/OFF</td></tr> </table>	W	CASAMBI	D	BALI		ON/OFF
	1	10W												
	2	20W												
	W	CASAMBI												
	D	BALI												
		ON/OFF												

NESO SLIM LINSE ZOOM

Option	Color T	CRI	Power	Lumen Output	Beam Angle
927	2700K	90	10W	246 - 370	20° to 50°
T27		THRIVE	10W	217 - 327	20° to 50°
930	3000K	90	10W	254 - 382	20° to 50°
T30		THRIVE	10W	225 - 239	20° to 50°
940	4000K	90	10W	262 - 393	20° to 50°
T40		THRIVE	10W	232 - 350	20° to 50°
927	2700K	90	20W	403 - 605	20° to 50°
T27		THRIVE	20W	356 - 534	20° to 50°
930	3000K	90	20W	415 - 624	20° to 50°
T30		THRIVE	20W	366 - 551	20° to 50°
940	4000K	90	20W	427 - 643	20° to 50°
T40		THRIVE	20W	376 - 567	20° to 50°

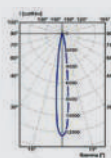

20°

50°

NESO SLIM LINSE ART



- incl.
- DIM
- 355°
- 90°
- 50.000hs
L70 / B10
- III
- MacAdam
2&3
- 24V
- 650°C

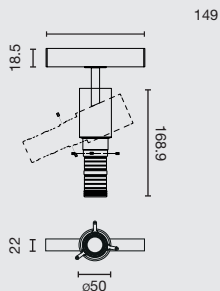

Family	Color T	Beam Angle	Finish	Control System
0392 Nesos Slim Linse Art	<ul style="list-style-type: none"> 1 10W 927 2700K CRI90 930 3000K CRI90 940 4000K CRI90 T27 2700K THRIVE T30 3000K THRIVE T40 4000K THRIVE 	7 Framers Spot	2 Black	<ul style="list-style-type: none"> W CASAMBI D DALI ON/OFF

NESO SLIM LINSE ART

Option	Color T	CRI	Power	Lumen Output	Beam Angle
927	2700K	90	10W	120 - 225	18° to 36°
T27		THRIVE	10W	108 - 203	18° to 36°
930	3000K	90	10W	124 - 232	18° to 36°
T30		THRIVE	10W	112 - 209	18° to 36°
940	4000K	90	10W	128 - 239	18° to 36°
T40		THRIVE	10W	116 - 216	18° to 36°

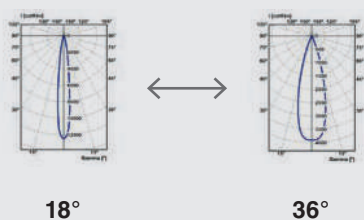



NESO POINT 3L

Option	Color T	CRI	Power	Lumen Output	Beam Angle
927	2700k	90	4W	217 / 221lm	12° / 34°
930	3000k	90	4W	292 / 298lm	12° / 34°

NESO POINT 6L

Option	Color T	CRI	Power	Lumen Output	Beam Angle
927	2700k	90	8W	480 / 487lm	12° / 34°
930	3000k	90	8W	506 / 512lm	12° / 34°

NESO POINT 12L

Option	Color T	CRI	Power	Lumen Output	Beam Angle
927	2700k	90	8W	1102 / 1109lm	12° / 34°
930	3000k	90	8W	1107 / 1112lm	12° / 34°

NESO LINE 32cm

Option	Color T	CRI	Power	Lumen Output	Beam Angle
927	2700k	90	6W	892lm	100°
930	3000k	90	6W	920lm	100°

NESO LINE 64cm

Option	Color T	CRI	Power	Lumen Output	Beam Angle
927	2700k	90	18W	1399lm	100°
930	3000k	90	18W	1442lm	100°

NESO HOLE ø3.5cm

Option	Color T	CRI	Power	Lumen Output	Beam Angle
927	2700k	90	5W	360 / 372lm	20° / 40°
930	3000k	90	5W	592 / 602lm	20° / 40°

NESO HOLE ø5cm

Option	Color T	CRI	Power	Lumen Output	Beam Angle
927	2700k	90	10W	825 / 932lm	18° / 36°
930	3000k	90	10W	954 / 961lm	18° / 36°

NESO HOLE ø7cm

Option	Color T	CRI	Power	Lumen Output	Beam Angle
927	2700k	90	20W	925 / 931lm	18° / 36°
930	3000k	90	20W	954 / 961lm	18° / 36°

NESO UNIK

Option	Color T	CRI	Power	Lumen Output	Beam Angle
927	2700k	90	5W	256lm	325°
930	3000k	90	5W	264lm	325°

NESO TOP

Option	Color T	CRI	Power	Lumen Output	Beam Angle
927	2700k	90	5W	360 / 371lm	20° / 40°
930	3000k	90	5W	444 / 452lm	20° / 40°

NESO SLIM POINT 12L

Option	Color T	CRI	Power	Lumen Output	Beam Angle
927	2700k	90	12W	816lm	25°
930	3000k	90	12W	841lm	25°

NESO SLIM POINT 24L

Option	Color T	CRI	Power	Lumen Output	Beam Angle
927	2700k	90	24W	1674lm	25°
930	3000k	90	24W	1726lm	25°

NESO SLIM LINE 30cm

Option	Color T	CRI	Power	Lumen Output	Beam Angle
927	2700k	90	6W	322lm	100°
930	3000k	90	6W	332lm	100°

NESO SLIM LINE 70cm

Option	Color T	CRI	Power	Lumen Output	Beam Angle
927	2700k	90	18W	875lm	100°
930	3000k	90	18W	902lm	100°

NESO SLIM HOLE ø3.5cm

Option	Color T	CRI	Power	Lumen Output	Beam Angle
927	2700k	90	5W	334 / 334lm	20° / 40°
930	3000k	90	5W	347 / 344lm	20° / 40°

NESO SLIM HOLE ø5cm

Option	Color T	CRI	Power	Lumen Output	Beam Angle
927	2700k	90	10W	545 / 572lm	18° / 36°
930	3000k	90	10W	562 / 590lm	18° / 36°

NESO SLIM UNIK

Option	Color T	CRI	Power	Lumen Output	Beam Angle
927	2700k	90	5W	230lm	325°
930	3000k	90	5W	237lm	325°

NESO SLIM TOP

Option	Color T	CRI	Power	Lumen Output	Beam Angle
927	2700k	90	5W	308 / 310lm	20° / 40°
930	3000k	90	5W	318 / 320lm	20° / 40°

NESO SLIM ANNA

Option	Color T	CRI	Power	Lumen Output	Beam Angle
927	2700k	90	6W	203lm	15°

NESO SLIM DIANA

Option	Color T	CRI	Power	Lumen Output	Beam Angle
927	2700k	90	6W	317lm	18°

NESO SLIM NINA

Option	Color T	CRI	Power	Lumen Output	Beam Angle
927	2700k	90	4W	108lm	18°

VIA

E V O L U T I O N



System designed for the general lighting of spaces. VIA system allows the creation of continuous light lines. We can also build different formats using the corner accessory. It can be used in surface, suspension or recessed installations.

Sistema diseñado para la iluminación general de espacios. VIA permite la creación de líneas de luz continuas. También podemos construir formatos diferentes utilizando el accesorio de esquina. Puede utilizarse en instalaciones de superficie, suspensión o empotradas.



VIA Collection



Track
59

MODULE

Modulo

	VIA 570 / 580	VIA 850 / 860	VIA 1130 / 1140
Surface Suspension Wall Light			
	570	850	1130
Recessed			
	580	860	1140

LIGHT DIRECTION

Dirección de la luz

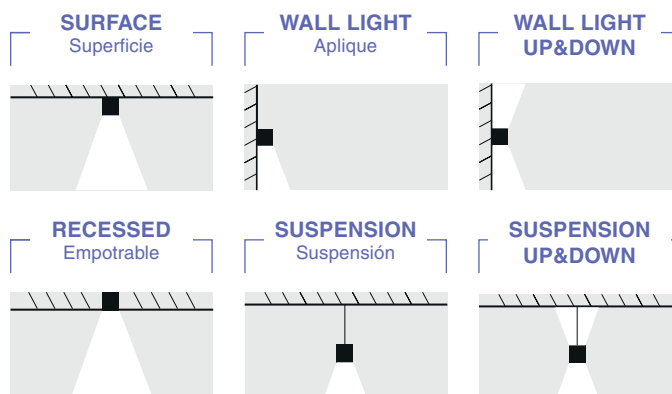

FINISH

Acabado

● **Black**
Negro

○ **White**
Blanco

COLOR TEMPERATURE

Temperatura de color

3000K CRI80

4000K CRI80

2700-3000K

DIFFUSER

Difusor



Opal



Microprism



UGR

CONTROL SYSTEM

Sistema de Control



CASAMBI

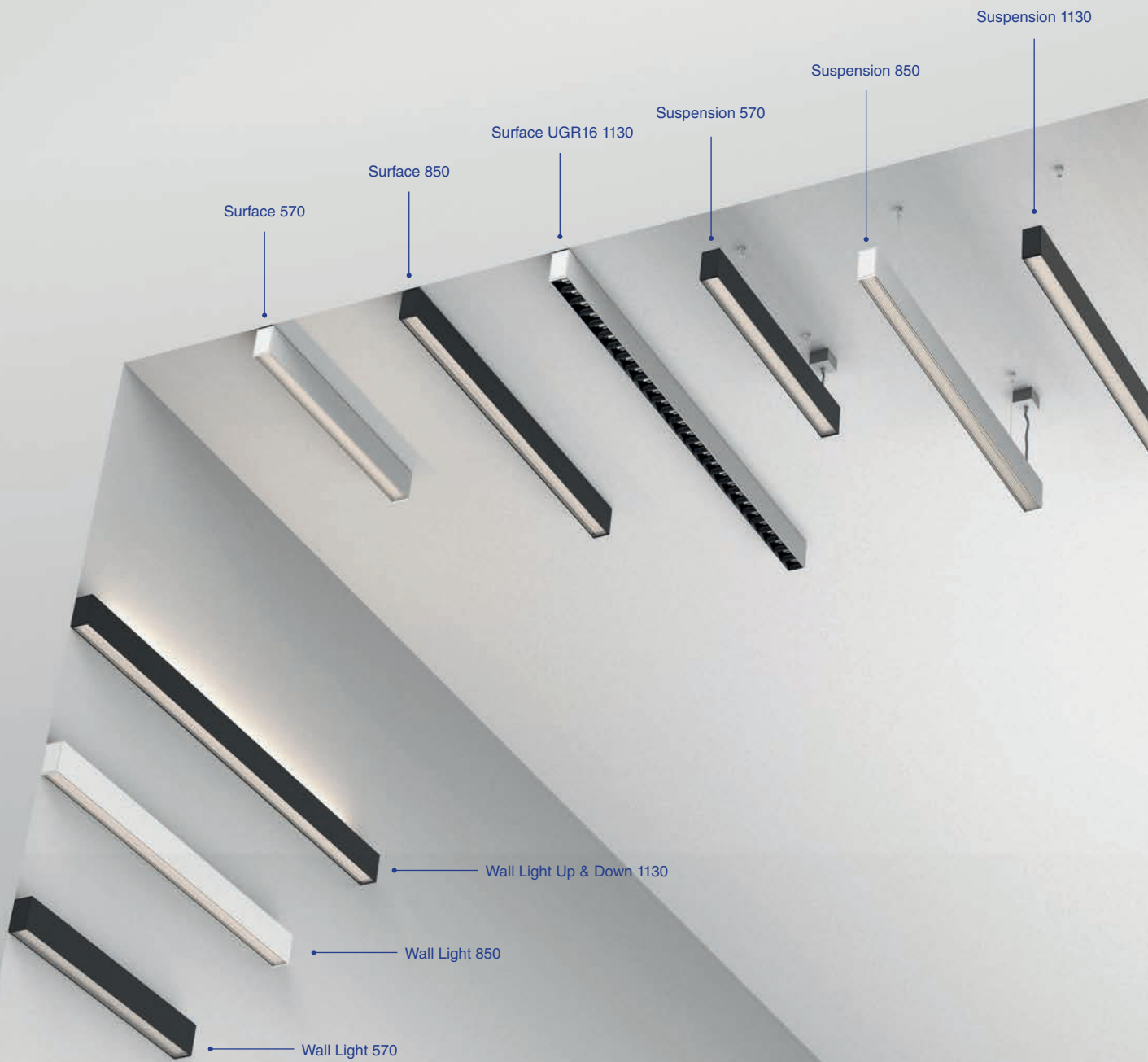

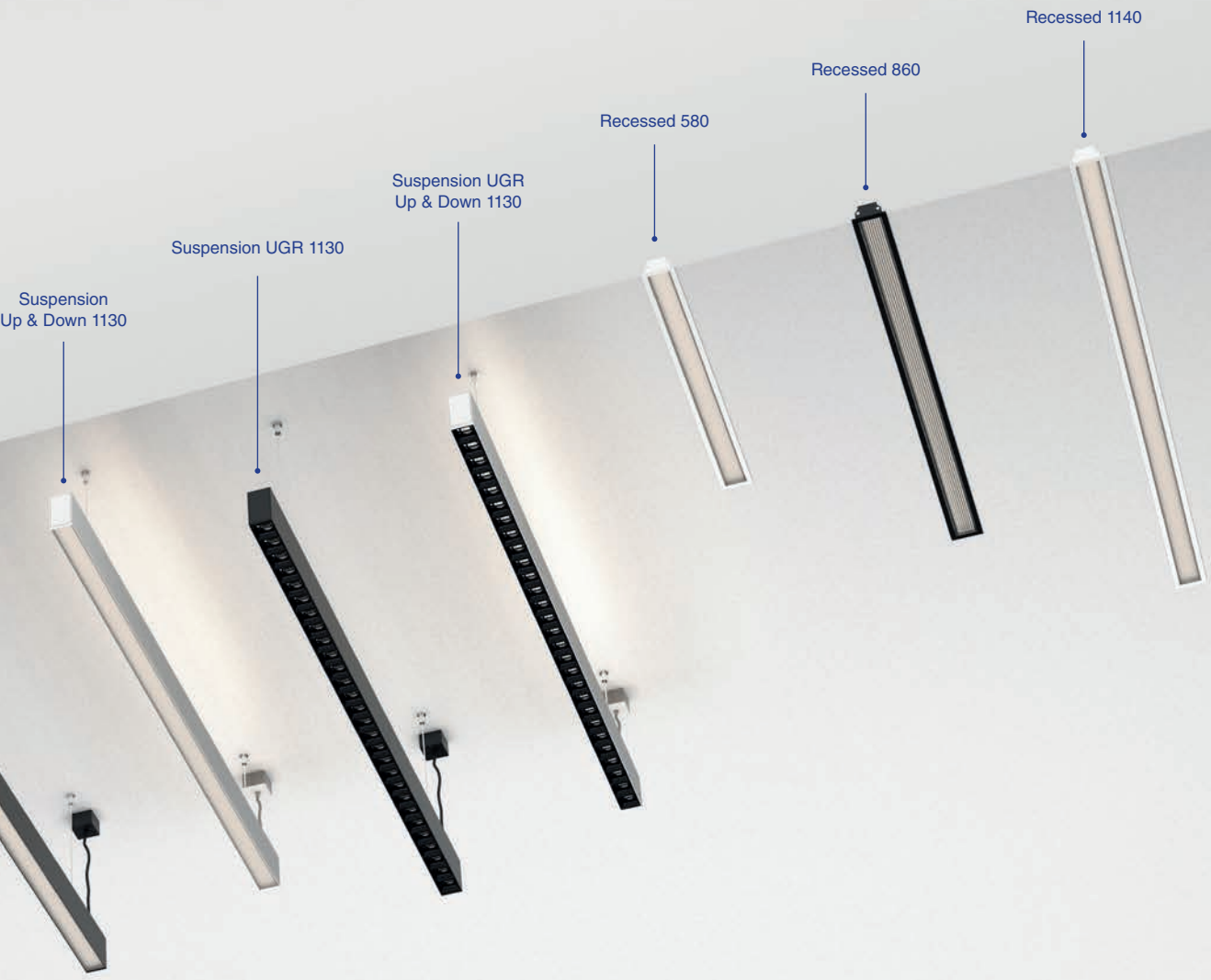



Suspension Accessory
Accesorio de Suspensión



Suspension Accessory DALI
Accesorio de Suspensión DALI



Continuous Accessory Surface (1 pcs)
Accesorio continuo de superficie (1 pcs)



Suspension Wire (2 pcs)
Alambre de Suspensión (2pcs)

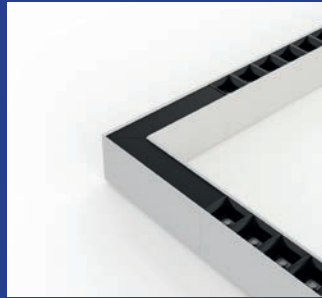

L-Shape Without Light
Esquina en L sin Luz



End Line Sensor
Sensor de Fin de Línea



Middle Line Sensor
Sensor de Línea Central

Accessories

	Suspension Accessory	Suspension Accessory Dali	L-Shape Without Light	Continuous Accessory Surface	Suspension Wire	End Line Sensor	Middle Line Sensor
●	040000093	040000095	040000091	040000097	040000098	040000089	040000101
●	040000094	040000096	040000090			040000099	040000100



Residential



Office



Microprism

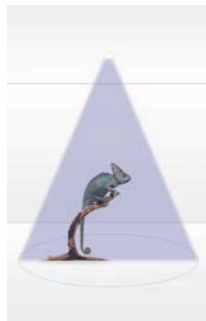

90°



Opal

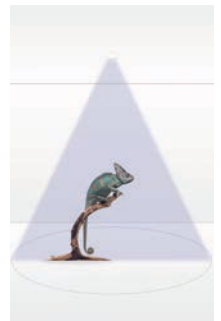

110°



UGR

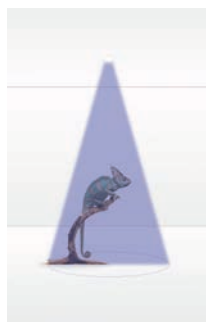

50°

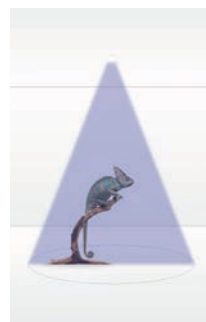

80°

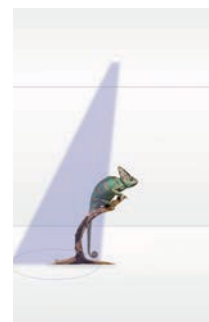

Asym°

VIA SURFACE & SUSPENSION 570

incl. DIM 50.000hs L80/B10 MacAdam 3 TW 220-240V 50 / 60Hz 650°C

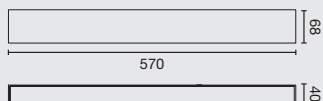

Family	Power	Finish	Control System	Diffuser
04100 Via Evo	590	Surface 15W 3000K CRI80	W CASAMBI	Opal
	570	Surface 25W 3000K CRI80	D DALI	U Microprisma
	680	Surface 15W 4000K CRI80	ON/OFF	
	660	Surface 25W 4000K CRI80		
04101 Via Evo	010	Surface 27W 2700-6500K TW	W CASAMBI	Opal
			D DALI	U Microprisma

04100

570

1

W

Example **041005701W** — Via Evo Surface 570 mm 25W 3000K Opal White

VIA SURFACE & SUSPENSION 850

incl. DIM 50.000hs L80/B10 MacAdam 3 TW 220-240V 50 / 60Hz 850°C

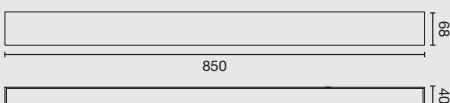

Family	Power	Finish	Control System	Diffuser
04100 Via Evo	560	Surface 20W 3000K CRI80	W CASAMBI	Opal
	540	Surface 38W 3000K CRI80	D DALI	U Microprisma
	650	Surface 20W 4000K CRI80	ON/OFF	
	630	Surface 38W 4000K CRI80		
04101 Via Evo	030	Surface 39W 2700-6500K TW	W CASAMBI	Opal
			D DALI	U Microprisma

VIA SURFACE & SUSPENSION 1130

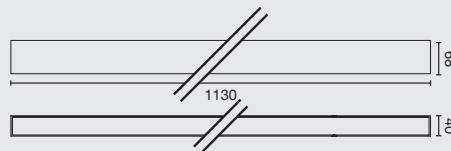

Family	Power	Finish	Control System	Diffuser
04100 Via Evo	530 Surface 27W 3000K CRI80	1 White	W CASAMBI	Opal
	510 Surface 51W 3000K CRI80	2 Black	D DALI	Microprisma
	620 Surface 27W 4000K CRI80		ON/OFF	
	600 Surface 51W 4000K CRI80			
04101 Via Evo	050 Surface 48W 2700-6500K TW	1 White	W CASAMBI	Opal
		2 Black	D DALI	Microprisma
04102 Via Evo	110 Surface UGR 32W 3000K CRI80	1 White	W CASAMBI	8 UGR<19 80°
	120 Surface UGR 32W 4000K CRI80	2 Black	D DALI	5 UGR<16 50°
	111 Surface UGR 17W 3000K CRI80		ON/OFF	0 UGR<19 asim.
	121 Surface UGR 17W 4000K CRI80			
04103 Via Evo	010 Surface UGR 54W 2700-6500K TW	1 White	W CASAMBI	8 UGR<19 80°
		2 Black	D DALI	5 UGR<16 50° 0 UGR<19 asim.

VIA L-SHAPE

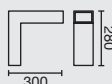
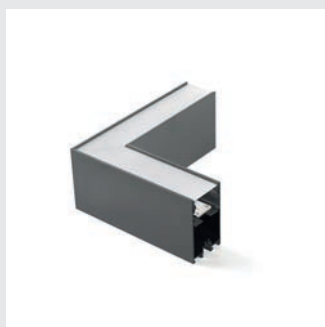

Accessory	Power	Finish	Control System	Diffuser
04100 L-shape	961 3000K 15W	1 White	W CASAMBI	Opal
	971 4000K 15W	2 Black	D DALI	Microprisma
	981 3000K 25W		ON/OFF	
	991 4000K 25W			
04100 L-shape	951 TW 27W	1 White	W CASAMBI	Opal
		2 Black	D DALI	Microprisma

Combine different VIA models. See colors to check compatibility of models in "L" installations or continuous lines.

Combina distintos modelos de VIA. Mira los colores para verificar las compatibilidades de modelos en instalaciones en "L" o líneas continuas.



VIA UP&DOWN 850

*Always order Suspension Kit
*Siempre pedir Kit de suspensión

incl. DIM 50.000hs L80/B10 MacAdam 3 220-240V 50 / 60Hz 650°C

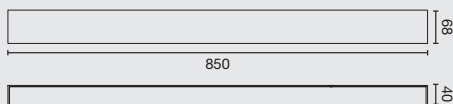

Family	Power	Finish	Control System	Diffuser						
04200 Via Evo	540	Up&down 14+38W 3000K CRI80	<table border="1"> <tr><td>W</td><td>CASAMBI</td></tr> <tr><td>D</td><td>BALI</td></tr> <tr><td></td><td>ON/OFF</td></tr> </table>	W	CASAMBI	D	BALI		ON/OFF	Opal
	W	CASAMBI								
D	BALI									
	ON/OFF									
630	Up&down 14+38W 4000K CRI80	<table border="1"> <tr><td>1</td><td>White</td></tr> <tr><td>2</td><td>Black</td></tr> </table>	1	White	2	Black	Microprisma			
1	White									
2	Black									

VIA UP&DOWN 1130

*Always order Suspension Kit
*Siempre pedir Kit de suspensión

incl. DIM 50.000hs L80/B10 MacAdam 3 220-240V 50 / 60Hz 650°C

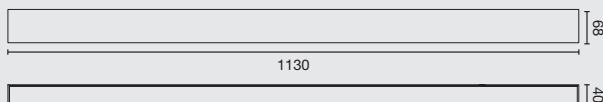

Family	Power	Finish	Control System	Diffuser						
04200 Via Evo	510	Up&down 21+51W 3000K CRI80	<table border="1"> <tr><td>W</td><td>CASAMBI</td></tr> <tr><td>D</td><td>BALI</td></tr> <tr><td></td><td>ON/OFF</td></tr> </table>	W	CASAMBI	D	BALI		ON/OFF	Opal
	W	CASAMBI								
D	BALI									
	ON/OFF									
600	Up&down 21+51W 4000K CRI80	<table border="1"> <tr><td>1</td><td>White</td></tr> <tr><td>2</td><td>Black</td></tr> </table>	1	White	2	Black	Microprisma			
1	White									
2	Black									

VIA UP&DOWN UGR 1130

*Always order Suspension Kit
 *Siempre pedir Kit de suspensión

incl. DIM 50.000hs L80/B10 MacAdam 3 220-240V 50 / 60Hz 650°C UGR 16

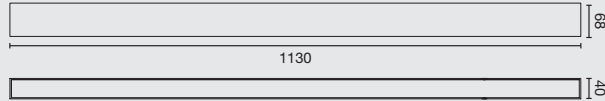

Family	Power	Finish	Control System	Diffuser
04202 Via Evo	110	Up&down UGR 24+32W 3000K CRI80	W CASAMBI	8 UGR<19 80°
	120	Up&down UGR 24+32W 4000K CRI80	D DALI	5 UGR<16 50°
		1 White	ON/OFF	0 UGR<19 asim.
		2 Black		

VIA RECESSED 580

incl. DIM 50.000hs L80/B10 MacAdam 3 TW 220-240V 50 / 60Hz 650°C



574x50

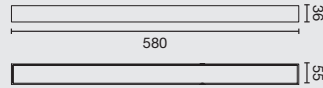

Family	Power	Finish	Control System	Diffuser						
04100 Via Evo	770	Recessed 15W 3000K CRI80	<table border="1"> <tr><td>W</td><td>CASAMBI</td></tr> <tr><td>D</td><td>BALI</td></tr> <tr><td></td><td>ON/OFF</td></tr> </table>	W	CASAMBI	D	BALI		ON/OFF	Opal
	W	CASAMBI								
	D	BALI								
		ON/OFF								
750	Recessed 25W 3000K CRI80	Black	Microprisma							
800	Recessed 15W 4000K CRI80									
780	Recessed 25W 4000K CRI80									
04101 Via Evo	020	Recessed 27W 2700-6500K TW	<table border="1"> <tr><td>W</td><td>CASAMBI</td></tr> <tr><td></td><td>BALI</td></tr> </table>	W	CASAMBI		BALI	Opal		
	W	CASAMBI								
	BALI									
		Black	Microprisma							

VIA RECESSED 860

incl. DIM 50.000hs L80/B10 MacAdam 3 TW 220-240V 50 / 60Hz 650°C

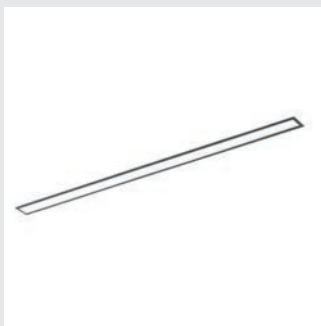

854x50



Family	Power	Finish	Control System	Diffuser						
04100 Via Evo	0830	Recessed 20W 3000K CRI80	<table border="1"> <tr><td>W</td><td>CASAMBI</td></tr> <tr><td>D</td><td>BALI</td></tr> <tr><td></td><td>ON/OFF</td></tr> </table>	W	CASAMBI	D	BALI		ON/OFF	Opal
	W	CASAMBI								
	D	BALI								
		ON/OFF								
0810	Recessed 38W 3000K CRI80	Black	Microprisma							
0860	Recessed 20W 4000K CRI80									
0840	Recessed 38W 4000K CRI80									
04101 Via Evo	040	Recessed 39W 2700-6500K TW	<table border="1"> <tr><td>W</td><td>CASAMBI</td></tr> <tr><td></td><td>BALI</td></tr> </table>	W	CASAMBI		BALI	Opal		
	W	CASAMBI								
	BALI									
		Black	Microprisma							

VIA RECESSED 1140

incl. DIM 50.000hs L80/B10 MacAdam 3 TW 220-240V 50 / 60Hz 650°C



1134x50

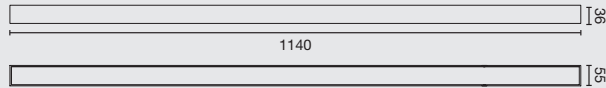

Family	Power	Finish	Control System	Diffuser
04100 Via Evo	0890 Recessed 27W 3000K CRI80	1 White	W CASAMBI	Opal
	0870 Recessed 51W 3000K CRI80	2 Black	D BALI	Microprisma
	0920 Recessed 27W 4000K CRI80		ON/OFF	
	0900 Recessed 51W 4000K CRI80			
04101 Via Evo	060 Recessed 48W 2700-6500K TW	1 White	W CASAMBI	Opal
		2 Black	BALI	Microprisma

VIA WALL LIGHT 570

incl. DIM 50.000hs L80/B10 MacAdam 3 TW 220-240V 50 / 60Hz 650°C

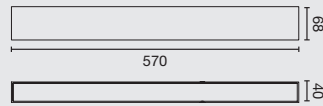

Family	Power		Finish	Control System	Diffuser
04100 Via Evo	595	Wall Light 15W 3000K CRI80	1 White	W CASAMBI	Opal
	575	Wall Light 25W 3000K CRI80	2 Black	D BALI	
	685	Wall Light 15W 4000K CRI80		ON/OFF	
	665	Wall Light 25W 4000K CRI80			
04101 Via Evo	015	Wall Light 27W 2700-6500K TW	1 White	W CASAMBI	Opal
			2 Black	BALI	

VIA WALL LIGHT 850

incl. DIM 50.000hs L80/B10 MacAdam 3 TW 220-240V 50 / 60Hz 650°C

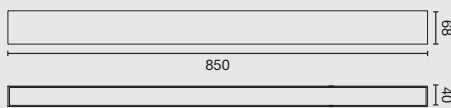

Family	Power		Finish	Control System	Diffuser
04100 Via Evo	565	Wall Light 20W 3000K CRI80	1 White	W CASAMBI	Opal
	545	Wall Light 38W 3000K CRI80	2 Black	D BALI	
	655	Wall Light 20W 4000K CRI80		ON/OFF	
	635	Wall Light 38W 4000K CRI80			
04101 Via Evo	035	Wall Light 39W 2700-6500K TW	1 White	W CASAMBI	Opal
			2 Black	BALI	

VIA WALL LIGHT 1130

incl. DIM 50.000hs L80/B10 MacAdam 3 TW 220-240V 50 / 60Hz 650°C

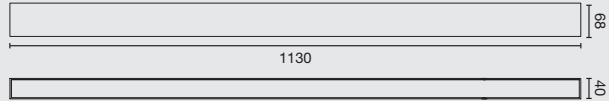

Family	Power		Finish	Control System	Diffuser
04100 Via Evo	535	Wall Light 27W 3000K CRI80	1 White	W CASAMBI	Opal
	515	Wall Light 51W 3000K CRI80	2 Black	D BALI	
	625	Wall Light 27W 4000K CRI80		ON/OFF	
	605	Wall Light 51W 4000K CRI80			
04101 Via Evo	055	Wall Light 48W 2700-6500K TW	1 White	W CASAMBI	Opal
			2 Black	BALI	

VIA WALL LIGHT UP&DOWN 850

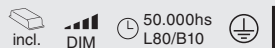

MacAdam 3 220-240V 50 / 60Hz 650°C

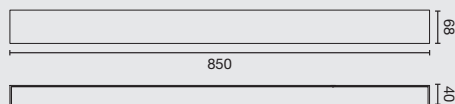

Family	Power		Finish	Control System	Diffuser
04200 Via Evo	545	Wall Light Up&Down 14+38W 3000K CRI80	1 White	W CASAMBI	Opal
	635	Wall Light Up&Down 14+38W 4000K CRI80	2 Black	D BALI ON/OFF	

VIA WALL LIGHT UP&DOWN 1130

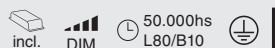

MacAdam 3 220-240V 50 / 60Hz 650°C

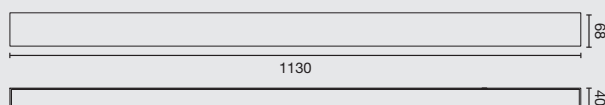

Family	Power		Finish	Control System	Diffuser
04200 Via Evo	515	Wall Light Up&Down 21+51W 3000K CRI80	1 White	W CASAMBI	Opal
	605	Wall Light Up&Down 21+51W 4000K CRI80	2 Black	D BALI ON/OFF	



VIA SURFACE & SUSPENSION

570mm						
Option	Color T	CRI	Difusor	Power	Lumen Output	Beam Angle
590	3000K	80	Opal / Microprisma	15W	1392lm / 1133lm	110° / 90°
570		80	Opal / Microprisma	25W	2506m / 2039m	110° / 90°
680	4000K	80	Opal / Microprisma	15W	1434lm / 1167lm	110° / 90°
660		80	Opal / Microprisma	25W	2581lm / 2100lm	110° / 90°
010	2700-6500K	TW	Opal / Microprisma	27W	1964lm / 1598lm	110° / 90°

850mm						
Option	Color T	CRI	Difusor	Power	Lumen Output	Beam Angle
560	3000K	80	Opal / Microprisma	20W	2131lm / 1735lm	110° / 90°
540		80	Opal / Microprisma	38W	3809lm / 3121lm	110° / 90°
650	4000K	80	Opal / Microprisma	20W	2195lm / 1787lm	110° / 90°
630		80	Opal / Microprisma	39W	3923lm / 3214lm	110° / 90°
030	2700-6500K	TW	Opal / Microprisma	39W	2985lm / 2429lm	110° / 90°

1130mm						
Option	Color T	CRI	Difusor	Power	Lumen Output	Beam Angle
530	3000K	80	Opal / Microprisma	27W	2842lm / 2313lm	110° / 90°
510		80	Opal / Microprisma	51W	5112lm / 4161lm	110° / 90°
620	4000K	80	Opal / Microprisma	27W	2927lm / 2382lm	110° / 90°
600		80	Opal / Microprisma	51W	5265lm / 4286lm	110° / 90°
050	2700-6500K	TW	Opal / Microprisma	48W	4006lm / 3261lm	110° / 90°
110	3000K	80	UGR<16 / UGR<19	32W	3989lm / 4104lm / 3739lm	50° / 80° / Asym
120	4000K	80	UGR<16 / UGR<19	32W	4109lm / 4227lm / 3851lm	50° / 80° / Asym
010	2700-6500K	TW	UGR<16 / UGR<19	54W	4830lm / 4881lm / 4467lm	50° / 80° / Asym

VIA UP&DOWN

850mm						
Option	Color T	CRI	Difusor	Power	Lumen Output	Beam Angle
540	3000K	80	Opal / Microprisma	14 + 38W	1240 + 3809lm / 1323 + 3121lm	110° / 90°
630	4000K	80	Opal / Microprisma	14 + 38W	1278 + 3923lm / 1363 + 3214lm	110° / 90°

1130mm						
Option	Color T	CRI	Difusor	Power	Lumen Output	Beam Angle
510	3000K	80	Opal / Microprisma	21 + 51W	2794 + 5112lm / 2794 + 4161lm	110° / 90°
600	4000K	80	Opal / Microprisma	21 + 51W	2878 + 5265lm / 2878 + 4286lm	110° / 90°

1130mm						
Option	Color T	CRI	Difusor	Power	Lumen Output	Beam Angle
110	3000K	80	UGR<16 / UGR<19	24 + 32W	2794 + 3989lm / 2794 + 4104lm / 2794 + 3739lm	50° / 80° / Asym
120	4000K	80	UGR<16 / UGR<19	24 + 32W	2878 + 4109lm / 2878 + 4227lm / 2878 + 3851lm	50° / 80° / Asym

VIA WALL LIGHT UP&DOWN

850mm						
Option	Color T	CRI	Difusor	Power	Lumen Output	Beam Angle
545	3000K	80	Opal	14+38W	1240 + 3809lm	110°
635	4000K	80	Opal	14+38W	1278 + 3923lm	110°

1130mm						
Option	Color T	CRI	Difusor	Power	Lumen Output	Beam Angle
515	3000K	80	Opal	21+51W	2794 + 5112lm	110°
605	4000K	80	Opal	21+51W	2878 + 5265lm	110°

VIA RECESSED

580mm

Option	Color T	CRI	Difusor	Power	Lumen Output	Beam Angle
770	3000K	80	Opal / Microprisma	15W	1392lm / 1133lm	110° / 90°
750		80	Opal / Microprisma	25W	2506m / 2039m	110° / 90°
800	4000K	80	Opal / Microprisma	15W	1434lm / 1167lm	110° / 90°
780		80	Opal / Microprisma	25W	2581lm / 2100lm	110° / 90°
020	2700-6500K	TW	Opal / Microprisma	27W	1964lm / 1598lm	110° / 90°

860mm

0830	3000K	80	Opal / Microprisma	20W	2131lm / 1735lm	110° / 90°
0810		80	Opal / Microprisma	38W	3809lm / 3121lm	110° / 90°
0860	4000K	80	Opal / Microprisma	20W	2195lm / 1787lm	110° / 90°
0840		80	Opal / Microprisma	38W	3923lm / 3214lm	110° / 90°
040	2700-6500K	TW	Opal / Microprisma	39W	2985lm / 2429m	110° / 90°

1140mm

0890	3000K	80	Opal / Microprisma	27W	2842lm / 2313lm	110° / 90°
0870		80	Opal / Microprisma	51W	5112lm / 4161lm	110° / 90°
0920	4000K	80	Opal / Microprisma	27W	2927lm / 2382lm	110° / 90°
0900		80	Opal / Microprisma	51W	5265lm / 4286lm	110° / 90°
060	2700-6500K	TW	Opal / Microprisma	48W	4006lm / 3261lm	110° / 90°

VIA WALL LIGHT

570mm

Option	Color T	CRI	Difusor	Power	Lumen Output	Beam Angle
595	3000K	80	Opal	15W	1392lm	110°
575		80	Opal	25W	2506m	110°
685	4000K	80	Opal	15W	1434lm	110°
665		80	Opal	25W	2581lm	110°
015	2700-6500K	TW	Opal	27W	1964lm	110°

850mm

565	3000K	80	Opal	20W	2131lm	110°
545		80	Opal	38W	3809lm	110°
655	4000K	80	Opal	20W	2195lm	110°
635		80	Opal	38W	3923lm	110°
035	2700-6500K	TW	Opal	39W	2985lm	110°

1130mm

535	3000K	80	Opal	27W	2842lm	110°
515		80	Opal	51W	5112lm	110°
625	4000K	80	Opal	27W	2927lm	110°
605		80	Opal	51W	5265lm	110°
055	2700-6500K	TW	Opal	48W	4006lm	110°

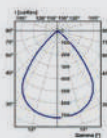

110°

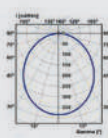

90°



50°

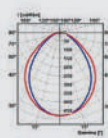

80°

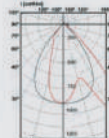

Asym°



FONOVIA is a concept of linear light that isolates us from the environment, creating moments of concentration thanks to its fabric with sound-absorbing properties that in turn softens the light creating spaces of well-being. It accompanies moments of concentration and privacy. Ideal for crowded spaces and meeting rooms.

FONOVIA es un concepto de luz lineal que nos aísla del entorno, creando momentos de concentración gracias a su tejido con propiedades fonoabsorbentes que a su vez suaviza la luz creando espacios de bienestar. Acompaña los momentos de concentración y de privacidad. Ideal para espacios concurridos y salas de reunión.

Designed by Faro Lab

FONOVIA





Office

Beam Angle

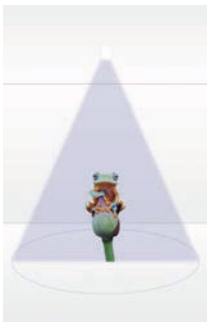

90°

MODULE
Modulo

Fonovia 156
25W

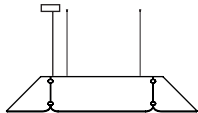

1560

Fonovia 240
50W

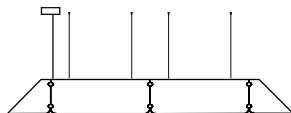

2400

Fonovia
Custom

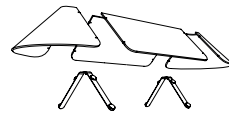

FINISH
Acabado

● **Grey**
Gris

COLOR TEMPERATURE
Temperatura de color

3000K CRI>80

4000K CRI>80

Highlights

Recycled PET PET reciclado

Because polyester accounts for approximately 60 percent of the world's production of PET, developing a non-virgin supply chain for polyester fiber has the potential to massively impact global energy and resource requirements.

Debido a que el poliéster representa aproximadamente el 60 por ciento de la producción mundial de PET, el desarrollo de una cadena de suministro no virgen para la fibra de poliéster tiene el potencial de impactar masivamente los requerimientos globales de energía y recursos.



Sound Absorbing $\alpha = 0.9$ Absorción acústica = 0,9

Noise in offices and workplaces has direct consequences on worker performance. The most immediate one is the reduction of their concentration. Workers exposed to continuous noise in their workplace are less effective in their work tasks. Concentration often means giving the brain a break to think better and focus on an activity. Luminaires made from fabrics with noise-absorbing properties are perfect for work spaces with high noise levels and acoustic distractions.



El ruido en las oficinas y lugares de trabajo tiene consecuencias directas en el rendimiento de los trabajadores. La más inmediata es la reducción de su concentración. Los trabajadores expuestos a un ruido continuo en su lugar de trabajo son menos eficaces en sus tareas. La concentración suele significar dar un respiro al cerebro para pensar mejor y centrarse en una actividad. Las luminarias fabricadas con tejidos con propiedades de absorción del ruido son perfectas para espacios de trabajo con altos niveles de ruido y distracciones acústicas.



FONOVIA 156cm 25W

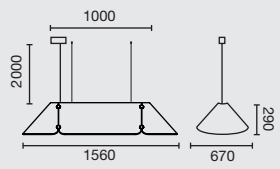

incl. 50.000hs L80 / B10 MacAdam 3 220-240V 50 / 60Hz 650°C

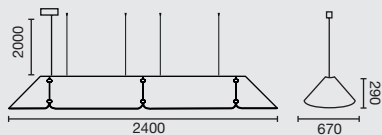

Reference	Finish	Power	Color T	Lumen Output
20110	● Grey	25W	 3000K CRI>80	1800lm
20109	● Grey	25W	 4000K CRI>80	1900lm

FONOVIA 240cm 50W



Reference	Finish	Power	Color T	Lumen Output
20107	● Grey	50W	 3000K CRI>80	3600lm
20108	● Grey	50W	 4000K CRI>80	3800lm

CONFIGURE YOUR

FONOVIA



1 Choose your via pendant composition

Escoge tu composición de via colgante

VIA SURFACE & SUSPENSION 850



Family	Power	Finish	Control System	Diffuser	
04100 Via Evo	560	Surface 20W 3000K CRI80	1 White	W CASAMBI	Opal
	540	Surface 38W 3000K CRI80	2 Black	D DALI	U Microprisma
	650	Surface 20W 4000K CRI80		ON/OFF	
	630	Surface 38W 4000K CRI80			
04101 Via Evo	030	Surface 39W 2700-6500K TW	1 White	W CASAMBI	Opal
			2 Black	D DALI	U Microprisma

VIA SURFACE & SUSPENSION 1130



Family	Power	Finish	Control System	Diffuser	
04100 Via Evo	530	Surface 27W 3000K CRI80	1 White	W CASAMBI	Opal
	510	Surface 51W 3000K CRI80	2 Black	D DALI	U Microprisma
	620	Surface 27W 4000K CRI80		ON/OFF	
	600	Surface 51W 4000K CRI80			
04101 Via Evo	050	Surface 48W 2700-6500K TW	1 White	W CASAMBI	Opal
			2 Black	D DALI	U Microprisma
04102 Via Evo	110	Surface UGR 32W 3000K CRI80	1 White	W CASAMBI	8 UGR<19 80°
	120	Surface UGR 32W 4000K CRI80	2 Black	D DALI	5 UGR<16 50°
			ON/OFF		0 UGR<19 asim.
04103 Via Evo	010	Surface UGR 54W 2700-6500K TW	1 White	W CASAMBI	8 UGR<19 80°
			2 Black	D DALI	5 UGR<16 50°
					0 UGR<19 asim.

2 Choose your pendant accessory

Escoge tu accesorio colgante

Pendant Accessory	Pendant Accessory DALI
○ 04000093	04000095
● 04000094	04000096

3

Dress your VIA EVO SYSTEM with fonovia sound absorbing shade system
Viste tu SISTEMA VIA EVO con el sistema de pantallas fonoabsorbentes fonovia

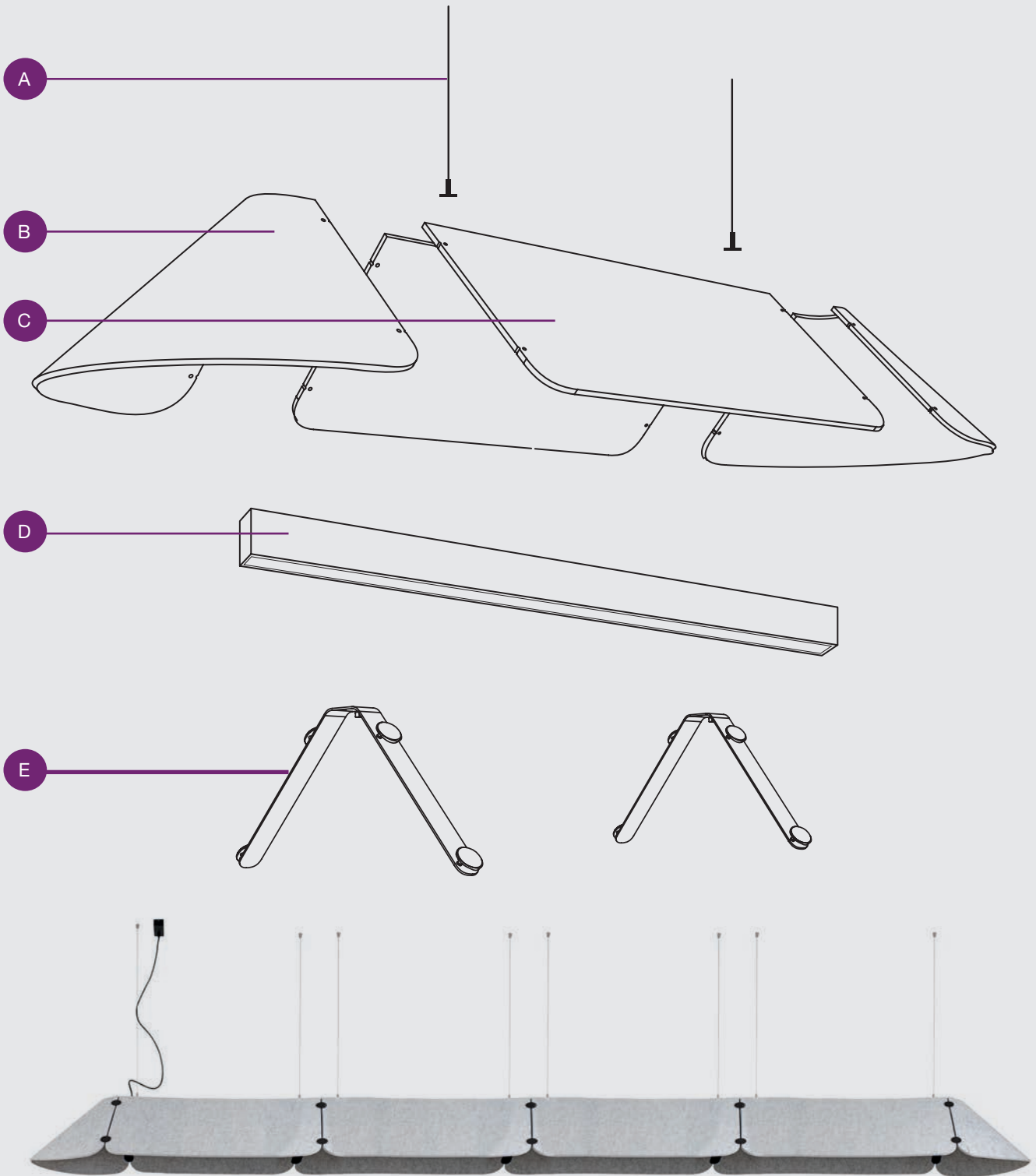

- Example
- 041005601W** — 4pc. x Via Evo Surface 20W 3000K CRI80 White Casambi
 - 041080001** — 4pc. x 2ud.Panels 837x400x9
 - 040000094** — 1pc. x Pendant Accessory
 - 040000098** — 4pc. x Accessory wire suspension
 - 041080004** — 5pc. x Mounting Kit
 - 041080003** — 1pc. x 2 Conics panels
 - 040000097** — 3pcs x Continuous accesory



A **Accessory wire suspension.**
Accesorio cables de suspensión.
1pc.— 04000098
For each VIA EVO.
Por cada VIA EVO.

Pendant Accessory.
Accesorio suspensión on/off.
1pc.— ○ 04000093
1pc.— ● 04000094
For each FONOVIA SYSTEM.
Por cada FONOVIA SYSTEM.

Pendant Accessory DALI.
Accesorio suspensión on/off.
1pc.— ○ 04000095
1pc.— ● 04000096
For each FONOVIA SYSTEM.
Por cada FONOVIA SYSTEM.



B **For each complete system of VIA EVO.**
Para cada sistema completo de VIA EVO.
1pc. — 041080003
2 Fonovia Conics Panels 359x664x9.
2 Paneles Fonovia Conics 359x664x9.



C **For each 850cm. VIA EVO.**
Por cada VIA EVO de 850cm.
1pc.— 041080001
2 Fonovia Panels 837x400x9 Light Grey.
2 Paneles Fonovia 837x400x9 Gris Claro.

For each 1130cm. VIA EVO.
Por cada VIA EVO de 1130cm.
1pc. — 041080002
2 Fonovia Panels 1117x400x9 Light Grey Claro.
2 Paneles Fonovia 1117x400x9 Gris.



D **Choose your VIA pendant composition.**
Escoge tu composición VIA colgante.

Include one mechanical connector for every two straight EVO tracks.
Incluya un mechanical connector por cada dos via EVO rectos.



E **041080004 — Mounting Kit**
If you have 1 VIA EVO, use 2 supports.
If you have 2 VIA EVO, use 3 supports.
If you have 3 VIA EVO, use 4 supports.
(Always one unit more than the number of tracks)

Si tienes 1 VIA EVO, usa 2 soportes.
Si tienes 2 VIA EVO, usa 3 soportes.
Si tienes 3 VIA EVO, usa 4 soportes.
(Siempre una unidad más que el número de luminarias VIA)

LEEDS

T R I P



LED STRIP
Tiras Led

MONOCHROMATIC
Monocolor

COB

IP67 NEON

5 W	15 W	Tunable White	Neon IP67
9,6 W	19,2 W	RGB	

IP RATING
Índice de protección

IP20	IP66	IP67
------	------	------





COLOR TEMPERATURE
Temperatura de color

2700K CRI80	3000K CRI80
4000K CRI80	2700-6500K
	

PROFILE
Perfiles

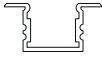
RECESSED
Empotrables



SURFACE
Superficie

FINISH
Acabado

 Black Negro	 White Blanco	 Silver Plateado
---	--	---

DIFFUSER
Difusor

	
Transparent	Opal

LEDSTRIP MONOCHROMATIC 5W/m

no incl. 5mt. DIM MacAdam 3 24V CRI>80

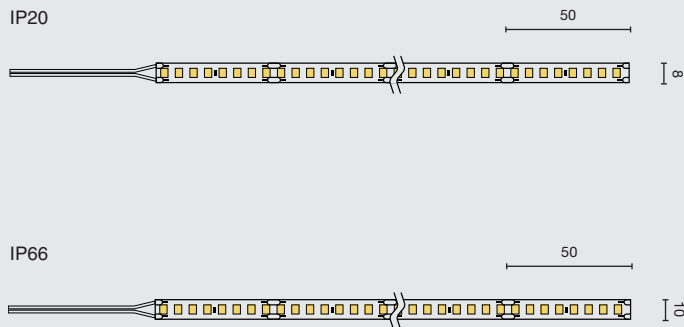

Ref	Power (W/m)	Color T	lm output/m	LED/m	IP	Cut
08050306	5W	2700K	700	160 led/m	20	50 mm
08050307	5W	3000K	725	160 led/m	20	50 mm
08050308	5W	4000K	775	160 led/m	20	50 mm
08050901	5W	2700K	625	160 led/m	66	50 mm
08050902	5W	3000K	650	160 led/m	66	50 mm
08050903	5W	4000K	675	160 led/m	66	50 mm

*Roll of 5m (500cm). You can order your own custom length every 10cm.
Cut to measure: ref. -XX, where XX=length (-01=0,1m, -02=0,2m, -14=1,4m...)

* Bobina de 5m (500cm) de longitud. Puede pedir su propia longitud personalizada cada 10cm.
Corte a medida: ref. -XX, donde XX=longitud (-01=0,1m, -02=0,2m, -14=1,4m...)

LEDSTRIP MONOCHROMATIC 9.6W/m

no incl. 5mt. DIM MacAdam 3 24V CRI>80

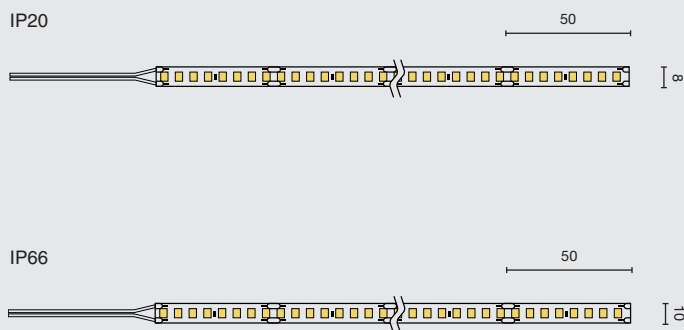

Ref	Power (W/m)	Color T	lm output/m	LED/m	IP	Cut
08050106	9.6W	2700K	1300	160 led/m	20	50 mm
08050107	9.6W	3000K	1320	160 led/m	20	50 mm
08050108	9.6W	4000K	1360	160 led/m	20	50 mm
08050301	9.6W	2700K	1300	160 led/m	66	50 mm
08050302	9.6W	3000K	1320	160 led/m	66	50 mm
08050303	9.6W	4000K	1360	160 led/m	66	50 mm

*Roll of 5m (500cm). You can order your own custom length every 10cm.
Cut to measure: ref. -XX, where XX=length (-01=0,1m, -02=0,2m, -14=1,4m...)

* Bobina de 5m (500cm) de longitud. Puede pedir su propia longitud personalizada cada 10cm.
Corte a medida: ref. -XX, donde XX=longitud (-01=0,1m, -02=0,2m, -14=1,4m...)



Architectural

Ledstrip

LEDSTRIP MONOCHROMATIC 15W/m

no incl. 5mt. DIM MacAdam 3 24V CRI>80

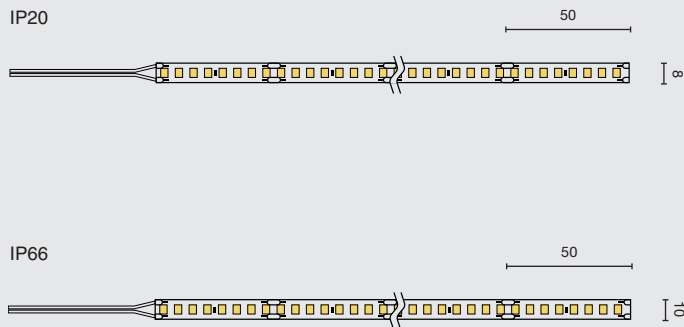

Ref	Power (W/m)	Color T	lm output/m	LED/m	IP	Cut
08050406	15W	2700K	2025	160 led/m	20	50 mm
08050407	15W	3000K	2070	160 led/m	20	50 mm
08050408	15W	4000K	2175	160 led/m	20	50 mm
08050801	15W	2700K	1800	160 led/m	66	50 mm
08050802	15W	3000K	1845	160 led/m	66	50 mm
08050803	15W	4000K	1950	160 led/m	66	50 mm

*Roll of 5m (500cm). You can order your own custom lenght every 10cm.
Cut to measure: ref. -XX, where XX=length (-01=0,1m, -02=0,2m, -14=1,4m...)

* Bobina de 5m (500cm) de longitud. Puede pedir su propia longitud personalizada cada 10cm.
Corte a medida: ref. -XX, donde XX=longitud (-01=0,1m, -02=0,2m, -14=1,4m...)

LEDSTRIP MONOCHROMATIC 19.2W/m

no incl. 5mt. DIM MacAdam 3 24V CRI>80

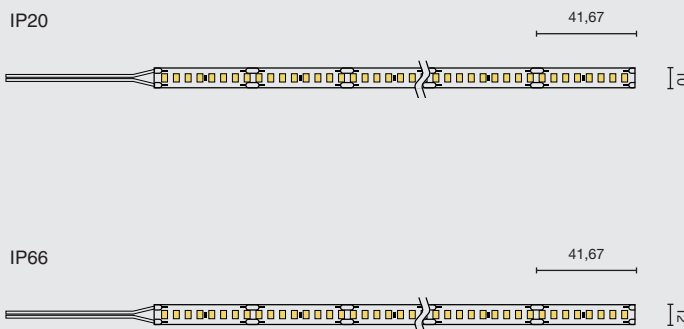

Ref	Power (W/m)	Color T	lm output/m	LED/m	IP	Cut
08050201	19.2W	2700K	2500	192 led/m	20	41,67 mm
08050202	19.2W	3000K	2520	192 led/m	20	41,67 mm
08050203	19.2W	4000K	2600	192 led/m	20	41,67 mm
08050401	19.2W	2700K	2500	192 led/m	66	41,67 mm
08050402	19.2W	3000K	2520	192 led/m	66	41,67 mm
08050403	19.2W	4000K	2600	192 led/m	66	41,67 mm

*Roll of 5m (500cm). You can order your own custom lenght every 12,5cm.
Cut to measure: ref. -XXXX, where XXXX=length (-0115=0,125m, -1000 =1m ...)

* Bobina de 5m (500cm) de longitud. Puede pedir su propia longitud personalizada cada 12,5cm
Corte a medida: ref. -XXXX, donde XXXX=longitud (-0125=0,125m, -1000 =1m ...)

ACCESSORIES

08050696	UNION ACCESSORY LED STRIP 8mm	Accesorio unión tira led 8mm
08050697	UNION ACCESSORY LED STRIP 10mm	Accesorio unión tira led 10mm
08050698	CONNECTOR CABLE ACCESSORY LED STRIP 8mm	Accesorio conector cable tira led 8mm
08050699	CONNECTOR CABLE ACCESSORY LED STRIP 10mm	Accesorio conector cable tira led 10mm



LEDSTRIP COB TUNABLE WHITE

no incl.  5mt.  DIM  24V  CRI>90  TW 

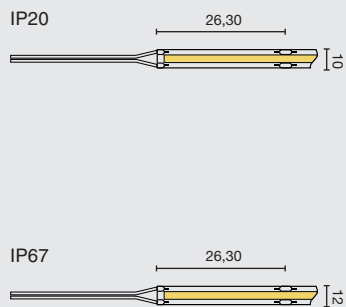

Ref	Power (W/m)	Color T	lm output/m	IP	Cut
08050501	12W + 12W	2700-6500K	1080 + 1248	20	26,3 mm
08050511	12W + 12W	2700-6500K	1080 + 1248	67	26,3 mm

*Roll of 5m (500cm). You can order your own custom lenght every 10,5cm.
Cut to measure: ref. -XXX, where XXX=length (-0105=0,105m, -1052 =1,052m ...)

* Bobina de 5m (500cm) de longitud. Puede pedir su propia longitud personalizada cada 10,5cm
Corte a medida: ref. -XXX, donde XXX=longitud (-0105=0,105m, -1052 =1,052m ...)

LEDSTRIP COB RGB

no incl.  5mt.  DIM  24V 

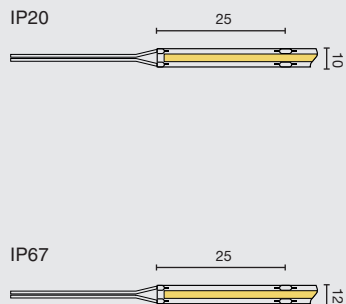

Ref	Power (W/m)	Color T	lm output/m	IP	Cut
08050601	15W	RGB	550	20	25 mm
08050611	15W	RGB	550	67	25 mm

*Roll of 5m (500cm). You can order your own custom lenght every 10cm.
Cut to measure: ef. -XXX, where XX=length (-01 =0,1m, -02=0,2m, -14=1,4m...)

* Bobina de 5m (500cm) de longitud. Puede pedir su propia longitud personalizada cada 10cm
Corte a medida: ref. -XXX, donde XX=longitud (-01 =0,1m, -02=0,2m, -14=1,4m...)

LEDSTRIP RGB WHITE

no incl.  5mt.  DIM  24V 



Ref	Power (W/m)	Color T	lm output/m	IP	Cut
08050706	24w	RGBWhite	1368	20	62mm

*Roll of 5m (500cm). You can order your own custom lenght every 10cm.
Cut to measure: ef. -XXX, where XX=length (-01 =0,1m, -02=0,2m, -14=1,4m...)

* Bobina de 5m (500cm) de longitud. Puede pedir su propia longitud personalizada cada 10cm
Corte a medida: ref. -XXX, donde XX=longitud (-01 =0,1m, -02=0,2m, -14=1,4m...)



LEDSTRIP NEON FRONT

IP67 5mt. DIM

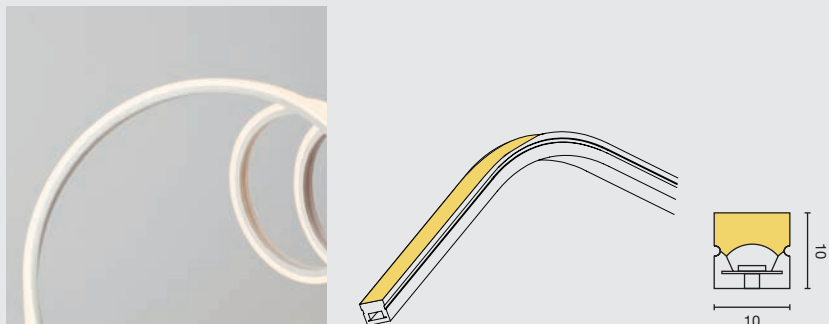

Ref	Power (W/m)	Color T	lm output/m	IP	Cut
08047001	14W	2700K	470	67	125mm
08048001	14W	3000K	470	67	125mm

*Roll of 5m (500cm). You can order your own custom lenght every 10cm.
Cut to measure: ef. -XXX, where XX=length (-01 =0,1m, -02=0,2m, -14=1,4m...)

* Bobina de 5m (500cm) de longitud. Puede pedir su propia longitud personalizada cada 10cm
Corte a medida: ref. -XXX, donde XX=longitud (-01 =0,1m, -02=0,2m, -14=1,4m...)

ACCESSORIES



08040098 ALUMINIUM CLIP Clip de aluminio

LEDSTRIP NEON SIDE

IP67 5mt. DIM

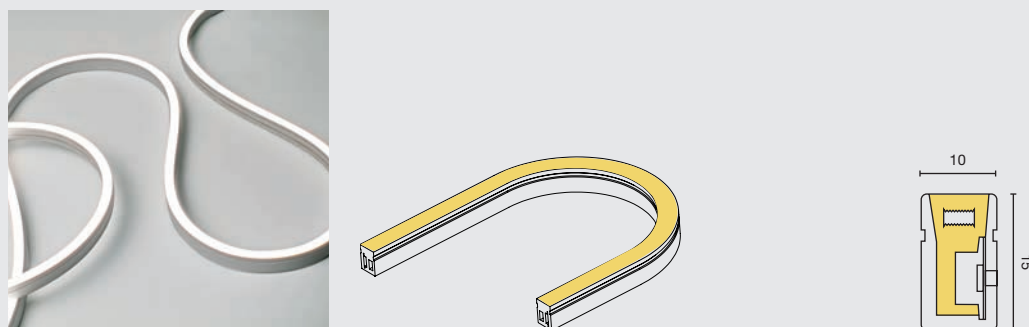

Ref	Power (W/m)	Color T	lm output/m	IP	Cut
08045001	14W	2700K	1060	67	50mm
08046001	14W	3000K	1060	67	50mm

*Roll of 5m (500cm). You can order your own custom lenght every 10cm.
Cut to measure: ef. -XXX, where XX=length (-01 =0,1m, -02=0,2m, -14=1,4m...)

* Bobina de 5m (500cm) de longitud. Puede pedir su propia longitud personalizada cada 10cm
Corte a medida: ref. -XXX, donde XX=longitud (-01 =0,1m, -02=0,2m, -14=1,4m...)

ACCESSORIES



08040099 ALUMINIUM CLIP Clip de aluminio



LEDSTRIP PROFILES

SURFACE PROFILES

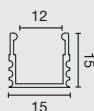

Ref	Finish	Long
08060101N	● Black	2000 mm
08060101B	○ White	2000 mm
08060101	● Silver	2000 mm

Ref	Accessorie	Finish
08060204N	End cap (2 pcs)	● Black
08060204B	End cap (2 pcs)	○ White
08060204	End cap (2 pcs)	● Silver

SURFACE PROFILES 8MM



Ref	Finish	Long
08080101N	● Black	2000 mm
08080101B	○ White	2000 mm
08080101	● Silver	2000 mm

Ref	Accessorie	Finish
08080204N	End cap (2 pcs)	● Black
08080204B	End cap (2 pcs)	○ White
08080204	End cap (2 pcs)	● Silver

*The LEDSTRIPS with a thickness equal to or greater than 10mm cannot be mounted with this profile.

*Las tiras LED con un un grosor igual o mayor de 10mm no pueden montarse con este perfil.

SURFACE PROFILES 45°

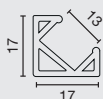
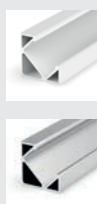
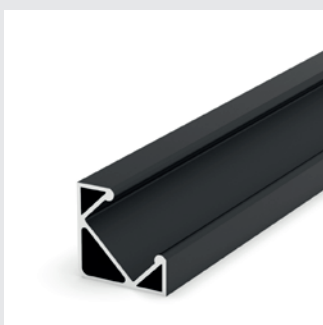

Ref	Finish	Long
08050101N	● Black	2000 mm
08050101B	○ White	2000 mm
08050101	● Silver	2000 mm

Ref	Accessorie	Finish
08050204N	End cap (2 pcs)	● Black
08050204B	End cap (2 pcs)	○ White
08050204	End cap (2 pcs)	● Silver

*The LEDSTRIPS with a thickness equal to or greater than 10mm cannot be mounted with this profile.

*Las tiras LED con un un grosor igual o mayor de 10mm no pueden montarse con este perfil.

RECESSED PROFILES

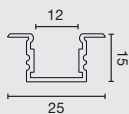
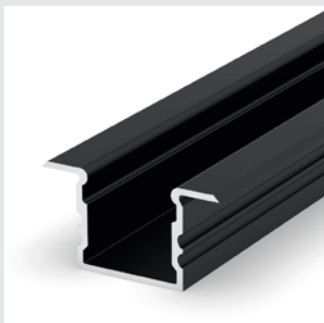

Ref	Finish	Long
08090101N	● Black	2000 mm
08090101B	○ White	2000 mm
08090101	● Silver	2000 mm

Ref	Accessorie	Finish
08070204N	End cap (2 pcs)	● Black
08070204B	End cap (2 pcs)	○ White
08070204	End cap (2 pcs)	● Silver

RECESSED PROFILES 8MM

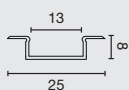

Ref	Finish	Long
08090111N	● Black	2000 mm
08090111B	○ White	2000 mm
08090111	● Silver	2000 mm

Ref	Accessorie	Finish
08090204N	End cap (2 pcs)	● Black
08090204B	End cap (2 pcs)	○ White
08090204	End cap (2 pcs)	● Silver

*The LEDSTRIPS with a thickness equal to or greater than 10mm cannot be mounted with this profile.

*Las tiras LED con un un grosor igual o mayor de 10mm no pueden montarse con este perfil.

OPAL DIFFUSER



Ref	Long
0806202	2000 mm

TRANSPARENT DIFFUSER



Ref	Long
0806203	2000 mm

CLIPS



08050105 ● Surface profile clip 45°



08060105 ● Surface & 15mm recessed clip



Light Control
Control de luz



Sunrise & Sunset
Amanecer y atardecer



Calendar & Timer
Calendario y Temporizador



Color T
Color T°



Grouping
Agrupación



Scenes
Escenas



Animations
Animaciones



Gallery
Galería



Daylight Sensor
Sensor de luz diurna



Occupancy Sensor
Sensor de ocupación

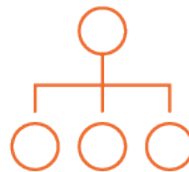

Control Hierarchy
Jerarquía de control

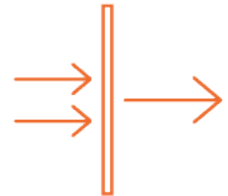

Gateway
Entrada



Scalability
Escalabilidad



Synchronization
Sincronización



Elements
Elementos



Parameters
Parámetros

This range of control elements offers customized solutions to optimize specific environments. Easily create dynamic spaces and energy efficient through control of lighting.

A hand holding a smartphone, with a network overlay of glowing nodes and lines. The background is a light blue gradient with abstract geometric shapes and binary code (01) scattered throughout.

CASAMBI
SMART
LIGHTING

Esta gama de elementos de control ofrece soluciones personalizadas para optimizar entornos específicos. Crea fácilmente espacios dinámicos y eficientes desde el punto de vista energético mediante el control de la iluminación.

Switch & Controls

Interruptores y controles

Switch for CASAMBI installations control
Interruptor para el control de instalaciones CASAMBI



97534

Allows dimming, calling scenes, controlling groups, all lamps and sequences. Works with Casambi APP and Casambi Models. Black or white colour. Lithium CR2430 battery, duration 2-5 years. Open range 60 metres. 4 general purpose buttons (scenes, individual, groups, sequences) plus 2 regulation buttons and 2 other buttons programmable by the Casambi APP.



97533

Permite regular, llamar a escenas, controlar grupos, todas las lámparas y secuencias. Funciona con la APP de Casambi y Modelos Casambi. Color negro o blanco. Pila CR2430 de Litio, duración 2-5 años. Alcance en abierto 60 metros. 4 botones de propósito general (escenas, individual, grupos, secuencias) más 2 botones de regulación y otros 2 botones programables por la APP de Casambi.

Switch 55
Interruptor 55

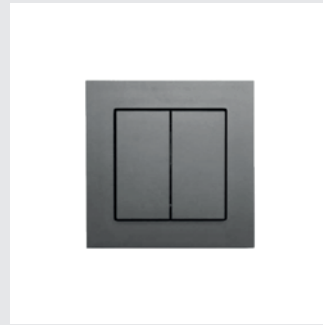

97536 Matt Anthracite Antracita Mate

4-channel bluetooth wireless push button with 2 keys. Completely autonomous (no battery or power supply), it works by mechanical impulses. It sends a radio signal thanks to the energy released when the keys are pressed and requires no maintenance.

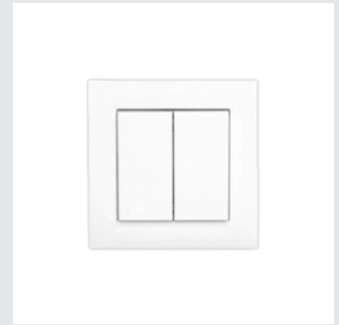

97537 Matt White Blanco Mate

Pulsador inalámbrico bluetooth de 4 canales mediante 2 teclas. Completamente autónomo (sin pila ni alimentación), funciona mediante impulsos mecánicos. Envía una señal de radio gracias a la energía liberada durante las pulsaciones de las teclas y no requiere mantenimiento.

Sensors

Sensores

Recessed Sensor
Sensor empotrado



97542

Surface Sensor
Sensor de superficie



97543

Bluetooth light level and presence sensor in recessed or surface format. Through the CASAMBI App, it can be configured to activate scenes, luminaires, when it detects presence, according to illuminance or circadian scenes. Recommended installation height between 2.4 and 5m. Detection diameter between 5 and 7m.

Sensor bluetooth de nivel de luz y presencia en formato de empotrar o superficie. A través de la App de CASAMBI se puede configurar para activar escenas, luminarias, cuando detecte presencia, según la iluminancia o escenas circadianas. Altura de instalación recomendada entre 2,4 y 5m. Diámetro de detección entre 5 y 7m.

Auxiliary Devices

Dispositivos auxiliares

CBU-DCS Bluetooth DALI controller
Controlador Bluetooth DALI CBU-DCS



97530

CBU-DCS is a Bluetooth controllable, Casambi enabled DALI controller. CBU-DCS does not have its own power supply. Instead, it is powered directly from a DALI bus.

CBU-DCS es un controlador DALI controlado por Bluetooth y habilitado por Casambi. CBU-DCS no tiene su propia fuente de alimentación. En su lugar, se alimenta directamente de un bus DALI.

Dimming for LED trips
Regulación de la intensidad luminosa para LED



97538

Dimming by CASAMBI for LED strips. 4 output channels. Max. total current 6 Ampere. Without push button input.

Regulación por CASAMBI para tiras LED. 4 canales de salida. Corriente máxima en total 6 Amperios. Sin entrada de pulsador.

CASAMBI to DALI converter
Convertidor de CASAMBI a DALI



97531

Built-in 120mA DALI source. Broadcast output, 4 groups, DT8 or RGBW. To control up to 60 DALI luminaires all at the same time.

Fuente DALI integrada de 120mA. Salida en Broadcast, 4 grupos, DT8 o RGBW. Para controlar hasta 60 luminarias DALI todas a la vez.

Casambi Repeater Module
Módulo repetidor Casambi



97532

With this module the range of the Bluetooth signal can be easily increased.

Con este módulo se puede aumentar fácilmente el alcance de la señal Bluetooth.

Plug & Play – Switch
Plug & Play – Interruptor



97540

Smart plug adapter for luminaires and electrical appliances. High switching capacity – up to 3680 W.

Adaptador de enchufe inteligente para luminarias y aparatos eléctricos. Gran capacidad de conmutación: hasta 3680W.



97541

Timer-Casambi
Temporizador Casambi



97544

TIMER-CASAMBI is a device that allows to keep memory of Casambi timers for scenarios when power supply is missing or because of a temporarily black-out.

TIMER-CASAMBI es un dispositivo que permite mantener la memoria de los temporizadores Casambi para los escenarios en los que falta la alimentación eléctrica o debido a un apagón temporal.

Casambi PWM4 IP65



97539

IP65 CBU-PWM4.

CBU-PWM4 en formato IP65.

DALI Elements

Elementos de DALI

Dali Touchpanel Basic C
Panel táctil DALI Basic C



97545

Capacitive touch panel with glass screen. Allows switching on, off and dimming of up to 3 groups or scenes of luminaires. Powered by DALI bus.

Panel táctil capacitivo con pantalla de cristal. Permite el encendido, apagado y regulación de hasta 3 grupos o escenas de luminarias. Alimentación por bus DALI.

Dali Touchpanel Basic TW
Panel táctil DALI Basic TW



97546

Allows easy control of Tuneable White luminaires via DALI protocol.

Permite controlar fácilmente las luminarias Tuneable White mediante protocolo DALI.

Dali USB Programmer
Programador USB DALI



97547

USB interface module for DALI system. Accessory for connecting software tools for addressing, programming and parameterisation of DALI installations and Faro Barcelona devices.

Módulo interfaz USB para sistema DALI. Accesorio para conectar herramientas software para direccionamiento, programación y parametrización de instalaciones DALI y dispositivos Faro Barcelona.

Dali PS1 Power Supply
Fuente de alimentación DALI PS1



97548

4W DALI power supply for stand-alone mounting, Accessory for supplying 200mA to DALI devices or control modules without their own standard power supply. Powered at 230-240V; 50/60Hz.

Alimentador DALI de 4W para montaje independiente, Accesorio para suministrar 200mA a dispositivos DALI o módulos de control sin su propia fuente de alimentación estándar. Alimentado a 230-240V; 50/60Hz.

Recessed DALI Sensor
Sensor DALI empotrado



97549

Light level and presence sensor using DALI protocol. Recessed and surface mounting format. Allows simple switching on, switching off and dimming of individual luminaires, groups of luminaires or scenes, either by presence or brightness detection. Power supply via DALI bus.

Sensor de nivel de luz y presencia mediante protocolo DALI. Formato de empotrar y superficie. Permite encender, apagar y regular de forma simple luminarias individuales, grupos de luminarias o escenas, ya sea por detección de presencia o luminosidad. Alimentación mediante Bus DALI.

Surface DALI Sensor
Sensor DALI de superficie



97550

Today's technology makes it possible to integrate thousands of luminaires and control functions into a single system based on a DALI control network or even centralise it in a BMS system. At Faro Barcelona we have concentrated all our experience and knowledge on simple solutions helping to find the necessary control elements to customise an installation.

Despite the complexity and size of the lighting installations, only a few components are needed to manage the entire system: Luminaires with DALI driver, DALI sensors (multisensors), DALI pushbuttons, DALI buttons, DALI Bus feeder and routers as a control unit.

La tecnología actual permite integrar miles de luminarias y funciones de control en un solo sistema basado en una red DALI de control o incluso centralizarlo en un sistema BMS. En Faro Barcelona hemos concentrado toda nuestra experiencia y conocimientos en soluciones simples ayudando a encontrar los elementos de control necesarios para personalizar una instalación.

A pesar de la complejidad y el tamaño de las instalaciones de iluminación, solo se necesitan algunos componentes para gestionar todo el sistema: Luminarias con driver DALI, sensores (multisensores) DALI, pulsadores DALI, botonas DALI, alimentador de Bus DALI y routers como unidad de control.

DALI and DALI-2 are open lighting standards. It is a digital protocol used worldwide to control lighting components, it allows to transfer information such as lighting commands, fault data, consumption and diagnostics between different devices.



SMART LIGHTING



DALI y DALI-2 son estándares abiertos de iluminación. Es un protocolo digital usado en todo el mundo para controlar componentes de iluminación, permite transferir información como los comandos de iluminación, los datos de fallos, consumos y los diagnósticos entre distintos dispositivos.

Recommended Drivers Drivers recomendados

Model	Power	mA	Control System	Driver	Units
TROOP	2W	700mA	ON/OFF	98310235	1-15
TROOP	2W	700mA	TRIAC	98310210	2-4
TROOP	2W	700mA	DALI	98310235D	1-15
TROOP	2W	700mA	CASAMBI	98310538	4-16
TROOP	3x2W	700mA	ON/OFF	98310235	1-4
TROOP	3x2W	700mA	TRIAC	98310220LC	2-3
TROOP	3x2W	700mA	DALI	98310235D	1-4
TROOP	3x2W	700mA	CASAMBI	98310538	2-5
TROOP	5x2W	700mA	ON/OFF	98310235	1-2
TROOP	5x2W	700mA	TRIAC	98310210	1
TROOP	5x2W	700mA	DALI	98310235D	1-2
TROOP	5x2W	700mA	CASAMBI	98310538	1-2
TROOP	4x2W	700mA	ON/OFF	98310235	1-3
TROOP	4x2W	700mA	TRIAC	98310210	1
TROOP	4x2W	700mA	DALI	98310235D	1-3
TROOP	4x2W	700mA	CASAMBI	98310538	1-3
TROOP	10x2W	700mA	ON/OFF	98310235	1
TROOP	10x2W	700mA	TRIAC	98310630C	1
TROOP	10x2W	700mA	DALI	98310235D	1
TROOP	10x2W	700mA	CASAMBI	98310538	1
NANO COLIN	7W	200mA	ON/OFF	98310510	1
NANO COLIN	7W	200mA	TRIAC	98310509C	1
NANO COLIN	13W	350mA	ON/OFF	98310136	1
NANO COLIN	13W	350mA	TRIAC	98310114C	1
NANO COLIN	13W	350mA	DALI	98310136D	1
NANO COLIN	13W	350mA	CASAMBI	98310538	1
MINI COLIN	18W	500mA	ON/OFF	98310336	1
MINI COLIN	18W	500mA	TRIAC	98310321LC	1
MINI COLIN	18W	500mA	DALI	98310336D	1
MINI COLIN	25W	700mA		98310235D	1
MINI COLIN	18W	500mA	CASAMBI	98310538	1
MINI COLIN	25W	700mA			
MINI COLIN	25W	700mA	ON/OFF	98310235	1
MINI COLIN	25W	700mA	TRIAC	98310630C	1
COLIN	24W	700mA	ON/OFF	98310235	1
COLIN	24W	700mA	TRIAC	98310630C	1
COLIN	24W	700mA	DALI	98310235D	1
COLIN	36W	1050mA		98310536	1
COLIN	24W	700mA	CASAMBI	98310538	1
COLIN	36W	1050mA			
COLIN	36W	1050mA	ON/OFF	98310444	1

Model	Power	mA	Control System	Driver	Units
OPTIC MINI	18W	500mA	ON/OFF	98310336	1
OPTIC MINI	18W	500mA	TRIAC	98310321LC	1
OPTIC MINI	18W	500mA	DALI	98310336D	1
	25W	700mA		98310235D	
OPTIC MINI	25W	700mA	ON/OFF	98310235	1
OPTIC MINI	25W	700mA	TRIAC	98310630C	1
OPTIC MINI	18W	500mA	CASAMBI	98310538	1
OPTIC MINI	25W	700mA			1
OPTIC	24W	700mA	ON/OFF	98310235	1
OPTIC	24W	700mA	TRIAC	98310630C	1
OPTIC	24W	700mA	DALI	98310235D	1
	36W	1050W		98310536	
OPTIC	24W	700mA	CASAMBI	98310538	1
	36W	1050W			
OPTIC	36W	1050mA	ON/OFF	98310444	1
DEEP S	6W	200mA	ON/OFF	98310510	1
DEEP S	6W	200mA	TRIAC	98310509C	1
DEEP S	11W	350mA	ON/OFF	98310136	1
DEEP S	11W	350mA	TRIAC	98310114C	1
DEEP S	11W	350mA	DALI	98310136D	1
DEEP S	11W	350mA	CASAMBI	98310538	1
DEEP M	12W	350mA	ON/OFF	98310136	1
DEEP M	12W	350mA	TRIAC	98310114C	1
DEEP M	18W	500mA	ON/OFF	98310336	1
DEEP M	18W	500mA	TRIAC	98310321LC	1
DEEP M	12W	350mA	DALI	98310136D	1
	18W	500mA		98310336D	
DEEP M	12W	350mA	CASAMBI	98310538	1
	18W	500mA			
DEEP L	18W	500mA	ON/OFF	98310336	1
DEEP L	18W	500mA	TRIAC	98310321LC	1
DEEP L	25W	700mA	ON/OFF	98310235	1
DEEP L	25W	700mA	TRIAC	98310630C	1
DEEP L	39W	1050mA	ON/OFF	98310444	1
DEEP L	18W	500mA	DALI	98310336D	1
	25W	700mA		98310235D	
	39W	1050mA		98310536	
DEEP L	18W	500mA	CASAMBI	98310538	1
	25W	700mA			
	39W	1050mA			

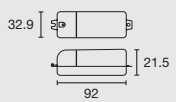
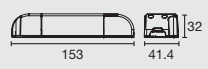
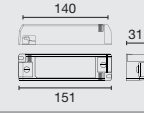
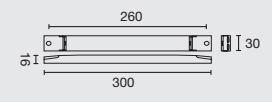
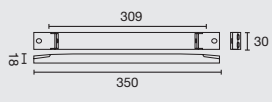
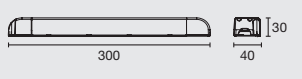
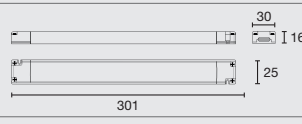
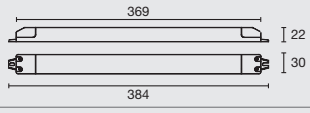
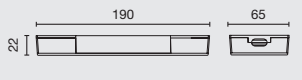
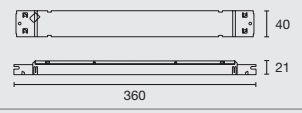
24V Power Supply

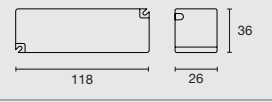
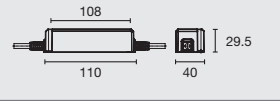
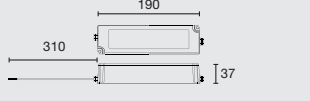
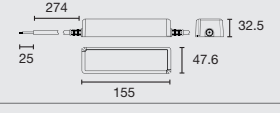
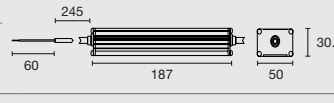
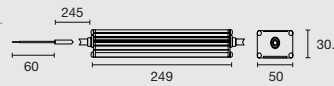
98324015U	15W	ON/OFF IP20	Constant voltage power supply for 24V DC. Supplies up to 15W, 100-240V, 50/60Hz.	Fuente de alimentación de voltaje constante para 24V DC. Suministra hasta 15W, 100-240V, 50/60Hz.	
98324030	30W	ON/OFF IP20	Constant voltage power supply for 24V DC. Supplies up to 30W, 220-240V, 50/60Hz.	Fuente de alimentación de voltaje constante para 24V DC. Suministra hasta 30W, 220-240V, 50/60Hz.	
98324060	60W	ON/OFF IP20	Constant voltage power supply for 24V DC. Supplies up to 60W, 220-240V, 50/60Hz.	Fuente de alimentación de voltaje constante para 24V DC. Suministra hasta 60W, 220-240V, 50/60Hz.	
98324061	60W	ON/OFF IP20	Constant voltage power supply for 24V DC. Supplies up to 60W, 220-240V, 50/60Hz.	Fuente de alimentación de voltaje constante para 24V DC. Suministra hasta 60W, 220-240V, 50/60Hz.	
98324099	100W	ON/OFF IP20	Constant voltage power supply for 24V DC. Supplies up to 100W, 220-240V, 50/60Hz.	Fuente de alimentación de voltaje constante para 24V DC. Suministra hasta 100W, 220-240V, 50/60Hz.	
98324120	120W	ON/OFF IP20	Constant voltage power supply for 24V DC. Supplies up to 120W, 220-240V, 50/60Hz.	Fuente de alimentación de voltaje constante para 24V DC. Suministra hasta 120W, 220-240V, 50/60Hz.	
98324150	150W	ON/OFF IP20	Constant voltage power supply for 24V DC. Supplies up to 150W, 220-240V, 50/60Hz.	Fuente de alimentación de voltaje constante para 24V DC. Suministra hasta 150W, 220-240V, 50/60Hz.	
98324200	200W	ON/OFF IP20	Constant voltage power supply for 24V DC. Supplies up to 0-150W@120V/0-200W@220-240V 50/60Hz.	Fuente de alimentación de voltaje constante para 24V DC. Suministra hasta 0-150W@120V/0-200W@220-240V 50/60Hz.	
98324100D	100W	DALI	Constant voltage power supply for 24V DC. Supplies up to 150W, 220-240V, 50/60Hz. DALI.	Fuente de alimentación de voltaje constante para 24V DC. Suministra hasta 100W, 220-240V 50/60Hz. DALI.	
98324150D	150W	DALI	Constant voltage power supply for 24V DC. Supplies up to 150W, 220-240V, 50/60Hz. DALI.	Fuente de alimentación de voltaje constante para 24V DC. Suministra hasta 100W, 220-240V 50/60Hz. DALI.	
98324599	120W	CASAMBI	Constant voltage power supply for 24V DC. Supplies up to 150W, 220-240V, 50/60Hz. CASAMBI.	Fuente de alimentación de voltaje constante para 24V DC. Suministra hasta 100W, 220-240V 50/60Hz. CASAMBI.	
98324026	26W	IP67	Constant voltage power supply for 24V DC. Supplies up to 26W, 220-240V, 50/60Hz. With protection rated at IP67.	Fuente de alimentación de voltaje constante para 24V DC. Suministra hasta 26W, 220-240V, 50/60Hz. Con protección clasificada en IP67.	
98324031	35W	IP67	Constant voltage power supply for 24V DC. Supplies up to 35W, 220-240V, 50/60Hz. With protection rated at IP67.	Fuente de alimentación de voltaje constante para 24V DC. Suministra hasta 35W, 220-240V, 50/60Hz. Con protección clasificada en IP67.	
98324100	100W	IP67	Constant voltage power supply for 24V DC. Supplies up to 100W, 220-240V, 50/60Hz. With protection rated at IP67.	Fuente de alimentación de voltaje constante para 24V DC. Suministra hasta 100W, 220-240V, 50/60Hz. Con protección clasificada en IP67.	
98324151	150W	IP67	Constant voltage power supply for 24V DC. Supplies up to 150W, 220-240V, 50/60Hz. With protection rated at IP67.	Fuente de alimentación de voltaje constante para 24V DC. Suministra hasta 150W, 220-240V, 50/60Hz. Con protección clasificada en IP67.	
98324101	100W	DALI	Constant voltage power supply for 24V DC. Supplies up to 100W, 220-240V, 50/60Hz. With protection rated at IP67. DALI.	Fuente de alimentación de voltaje constante para 24V DC. Suministra hasta 100W, 220-240V, 50/60Hz. Con protección clasificada en IP67. DALI.	
98324151D	150	DALI	Constant voltage power supply for 24V DC. Supplies up to 150W, 220-240V, 50/60Hz. With protection rated at IP67. DALI.	Fuente de alimentación de voltaje constante para 24V DC. Suministra hasta 150W, 220-240V, 50/60Hz. Con protección clasificada en IP67. DALI.	

Simbology

	Luminaires of insulation class I are provided with a connection for the earthing conductor (PE) and are not specially marked.	Las luminarias de la clase de aislamiento I están provistas de una conexión para el conductor de puesta a tierra (PE) y no están identificadas de forma especial.
	Luminaires with insulation class II	Luminarias con clase de aislamiento II
	Luminaires with insulation class III	Luminarias con clase de aislamiento III
 incl.	Driver included	Equipo electrónico incluido
 no incl.	Driver not included	Equipo electrónico no incluido
 2mt.	Cable meters	Metros de cable
 50.000hs L80/B10	LED lifetime	Vida útil LED
 20°	Cardanic orientation	Orientación cardánica
 355°	Vertical orientation degrees	Grados de orientación vertical
 355°	Horizontal orientation degrees	Grados de orientación horizontal
 30°	Vertical orientation degrees	Grados de orientación vertical
 30°	Vertical orientation degrees	Grados de orientación vertical
 850°C	Compliance of incandescent wire regulatory	Cumplimiento de la normativa incandescente de alambre.
	Cut out	Agujero para empotrar
	MacAdam ellipses	Elipses de MacAdam
	Dimmers are devices used to vary the brightness of a light.	Los Dimmers son dispositivos utilizados para variar la intensidad de la luz.
	Tunable White. Luminaires with variable colour temperature control from warm white to cool white.	Tunable White. Luminarias con control variable de la temperatura de color desde la luz blanca cálida hasta el blanco frío.
	Unified Glare Rating	Unified Glare Rating Índice de Deslumbramiento Unificado



FUECO
AIC

FARO
BARCELONA

10
FARO
BARCELONA



Request visit

**Showroom Barcelona**

Princesa 52
08003 Barcelona
Spain
Tel +34932387373
showroom.barcelona@faro.es

Showroom Madrid

Velázquez 35 4ºD
28001 Madrid
Spain
Tel +34689583571
showroom.madrid@faro.es

Showroom Paris

7 Rue d'Uzès
75002 Paris
France
Tel +33745061553
showroom.paris@faro.es

Showroom Buenos Aires

Ven Street Center Local 30
Av. Italia 4950
1622 Dique Luján
Buenos Aires Argentina
Tel +5491171390813
showroom.argentina@faro.es

Logistics Headquarters

Dinámica 1 Pol. Ind. Santa Rita
08755 Castellbisbal
Spain
Tel +34937723949
info@faro.es

Logistics China

Room 1706-05, Glory International
Finance Center
25 Guicheng Road, Nanhai District
Foshan, Guangdong Province

Logistics USA

135 West 41nd Street Suite 1002
10036 New York
USA

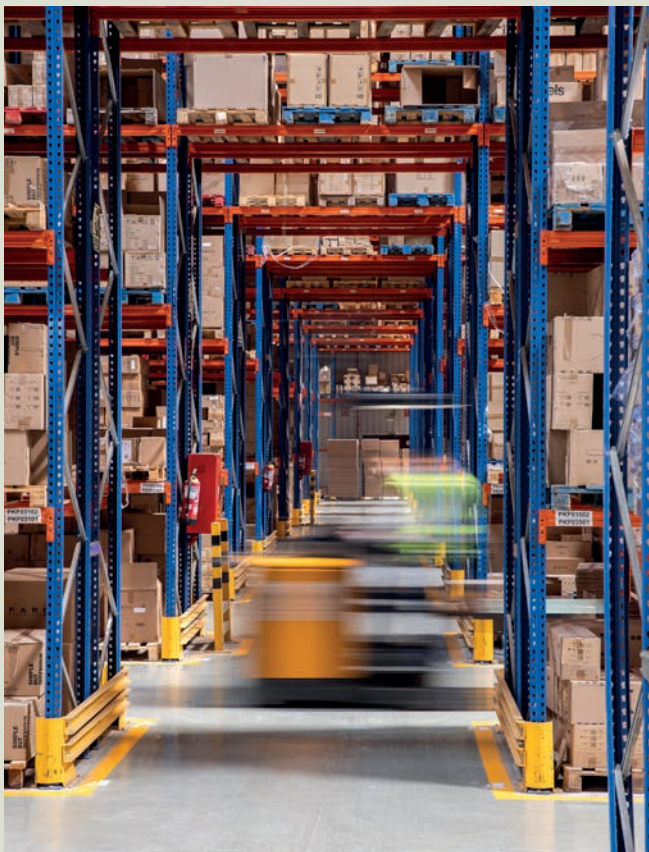

Be present.
Let light guide you
to a more conscious
way of living