

ESSENCE™  
LINEAR LIGHTING SYSTEM





ESSENCE U-SERIES LED TAPE  
ENTRA CL3 RECESSED, WHITE ROUND BEVEL TRIM

Where light is placed has a significant impact on visibility, visual comfort, aesthetics, task performance, safety, mood, satisfaction, and social interaction. ESSENCE™ provides premier quality made-to-order architectural light channels and premium LED tape. ESSENCE is easy to specify, easy to install, backed by short lead times and Tech Lighting's impeccable service and will elevate any space.

## ELEVATE YOUR SPACE WITH ESSENCE™ LINEAR LIGHTING

Small form factor, linear task and accent lighting is critical in residential and commercial spaces to layer light and create visual interest while placing light exactly where it's needed.





ESSENCE RECESSED FLANGED 0606 U-SERIES STATIC WHITE, WHITE  
KLEE 38 FLOOR LAMP, POLISHED NICKEL

# UNMATCHED COLOR QUALITY AND CONSISTENCY

The quality of light is critical to ensure other design elements in the space are presented in the most natural way possible. Additionally, LED Tape and Channels are oftentimes in close proximity to a surface - frequently a white or light-colored surface which tends to pick up LED color variances adjacent to each other. ESSENCE utilizes a proprietary phosphor mix and hand selects from over 1 billion LEDs each year to achieve unmatched color quality and consistency.

**CRI:** Using a scale of 0-100, CRI indicates how well a light source renders 8 colors compared to a natural light source.

U SERIES	P SERIES	WARM DIM
97+	95+	95+

**Color binning:** Indicates how consistent color is from LED-to-LED along the black body curve of natural light. 1-step color binning helps ensure color variance is imperceptible to the human eye.

U SERIES	P SERIES	WARM DIM
1-STEP	2-STEP	2-STEP

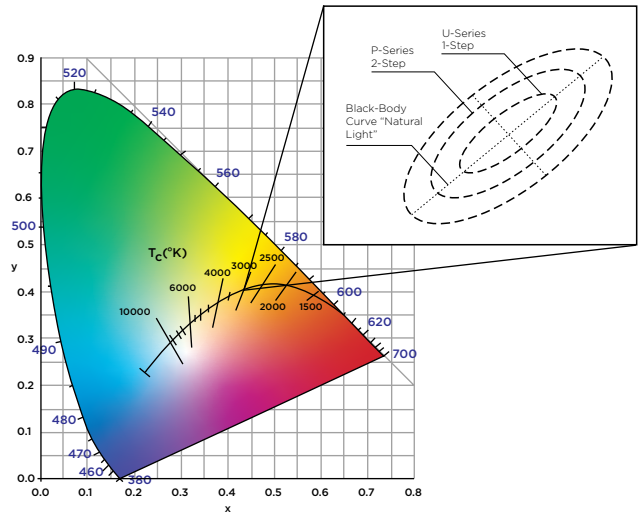

**R<sub>g</sub>:** Indicates how well a light source renders RED, on a scale of 0-100, compared to a natural light source.

U SERIES	P SERIES	WARM DIM
95+	90+	90+

**GAMUT (R<sub>g</sub>):** Scores below 100 indicate the color is less saturated than under sunlight, while scores above 100 mean the colors are more intense than under sunlight. Scores of 100 mirror natural light.

U SERIES	P SERIES	WARM DIM
100	95-105	95

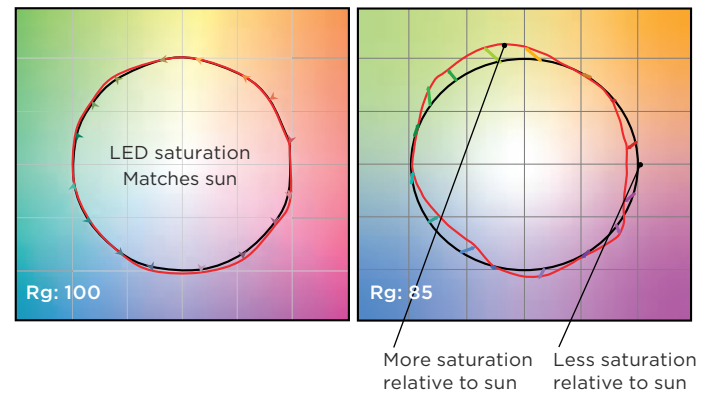

**FIDELITY (R<sub>f</sub>):** On a scale of 0-100, R<sub>f</sub> indicates how well a light source renders 99 colors chosen from real world objects, compared to natural light.

U SERIES	P SERIES	WARM DIM
95+	90+	90+

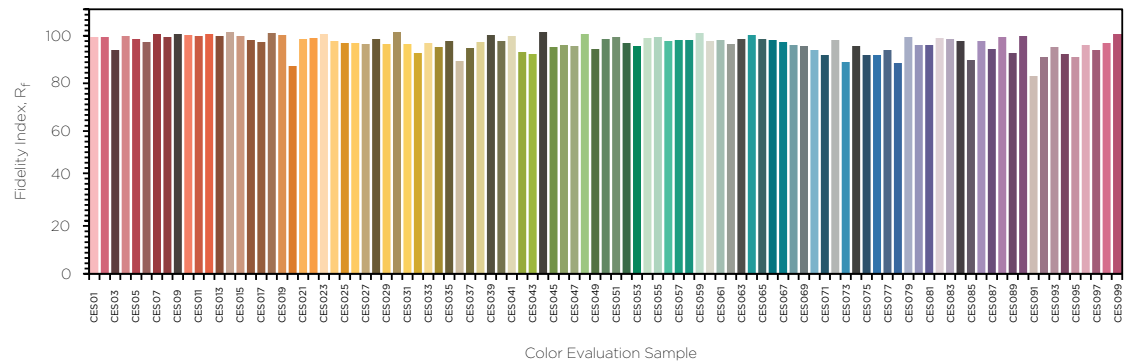

## SUPERIOR LED TAPE

Whether utilized stand-alone or inside of a channel, ESSENCE LED Tape is engineered to provide beautiful light with maximum flexibility, consistent brightness, minimal shadowing and long life.

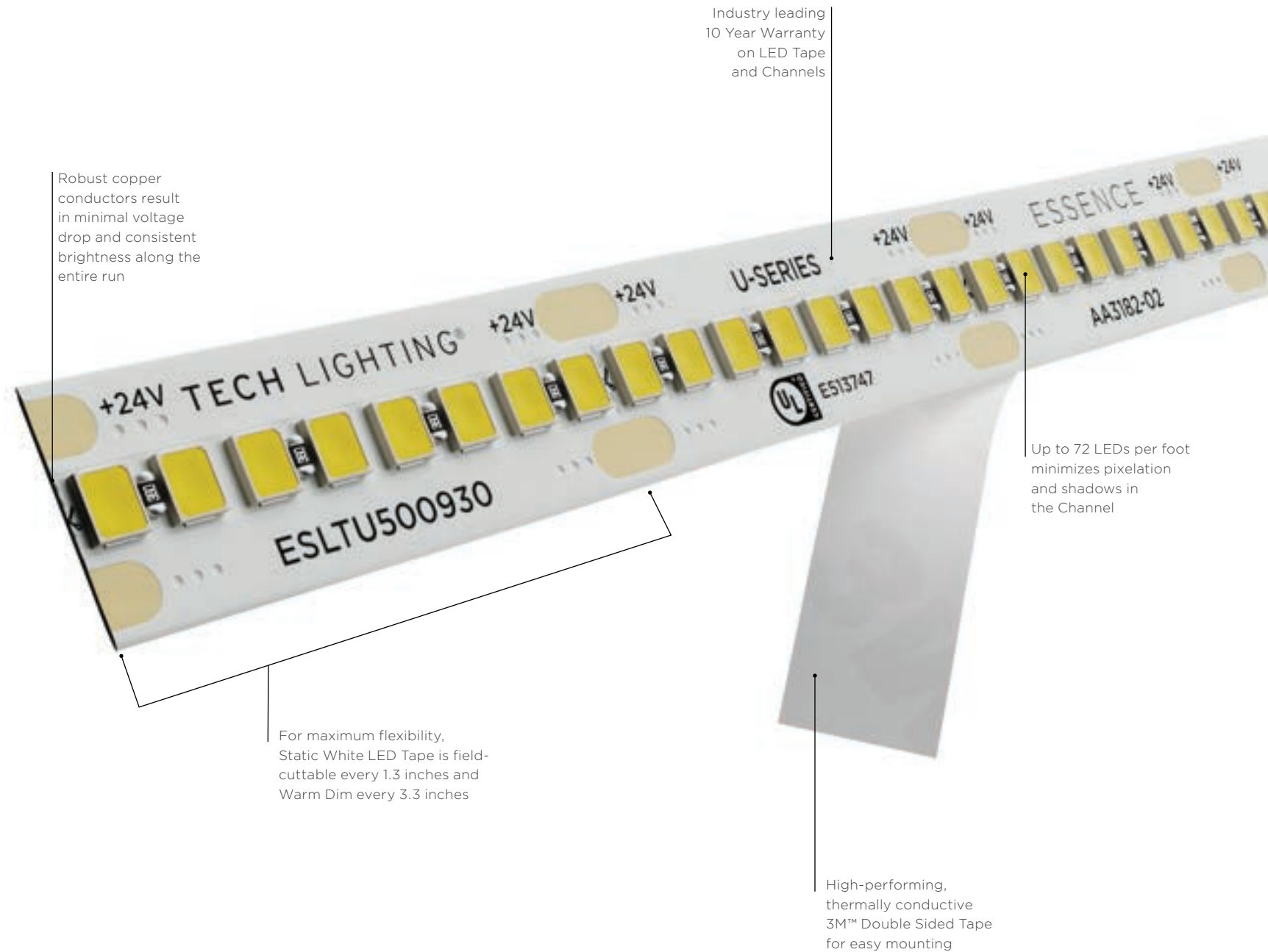

# PREMIUM CHANNEL AESTHETICS

## APPLICATION OPTIONS

A range of profiles are available to service a wide variety of Surface and Recessed applications.

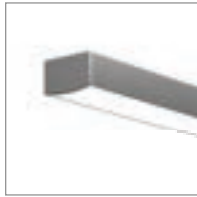

Shallow Surface Mount  
ESSF0604

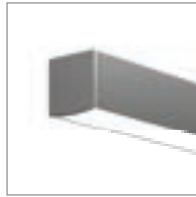

Surface Mount  
ESSF0606

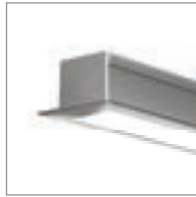

Recessed Flanged  
ESRW0606

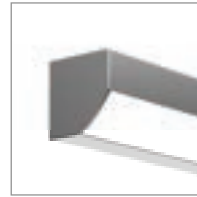

45 Degree  
ES45

## ALUMINUM EXTRUSION

ESSENCE Channels are manufactured to provide a tailored, quality aesthetic. Available in anodized Black, Satin Aluminum and White (field paintable) finishes.



## MOUNTING HARDWARE

For a clean aesthetic, mounting hardware is concealed inside the channel. Each Channel ships with 3M™ Mounting Tape and Mounting Clips.

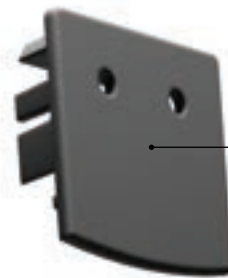

## ULTRA THIN ENDCAPS

Engineered to eliminate light leak at the seams and provide a clean, finished look at the start and end of a Channel.



## PREMIUM LED TAPE

Engineered for maximum color quality, color consistency and brightness while minimizing LED pixelation.



## UNINTERRUPTED CHANNEL

Concealed Channel Joiner allows for continuous, uninterrupted runs up to 600".

## ACRYLIC LENS

Optimizes light output while minimizing glare and LED pixelation.

ESSENCE offers two Lens options: The White Lens offers a premium aesthetic engineered to eliminate LED pixelation and minimize glare - a great solution for applications where the channel is visible. The Frosted Lens offers increased light output while softening glare.

WHITE LENS  
Eliminates LED pixels



ESSF0606 - SHOWN ON



ESSF0606 - SHOWN OFF

FROSTED LENS  
Reduces LED pixels



ESSF0606 - SHOWN ON



ESSF0606 - SHOWN OFF

PROFILE	WHITE LENS		FROSTED LENS	
	STATIC WHITE	WARM DIM	STATIC WHITE	WARM DIM
0604	NP	FP	SP	FP
0606/45	NP	NP	NP	FP

FP Full Pixelation

SP Some Pixelation, particularly at lower dim levels

NP No Pixelation





ESSENCE SURFACE MOUNT 0606 WARM DIM, SATIN ALUMINUM

## EASY SPECIFICATION & INSTALLATION

Specifying ESSENCE™ is easy. Light Channels are ordered to the actual length (including End Caps) up to 50 feet and LED Tape is field cuttable every 1.3 inches (3.3 inches for Warm Dim) allowing for ultimate flexibility in specifying and installation. For less than 1 inch increments, please contact our Custom Quotes Team.

### MOUNTING HARDWARE

Concealed beneath the channel to eliminate visible hardware. Each Channel ships with 3M™ Mounting Tape and Mounting Clips.



### UNINTERRUPTED CHANNEL

Concealed Channel Joiner allows for continuous, uninterrupted runs up to 600" (included with any channel greater than 96").

#### Accessories (included with channel)



Recessed Mounting Clip



Surface Mounting Clip

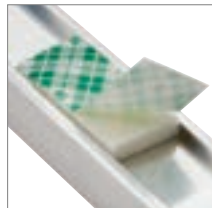

3M™ Tape Mounting



Joiner  
Included in runs over 96"



End Cap

#### Accessories (ordered separately)



Wire Management Clip



Splice Box

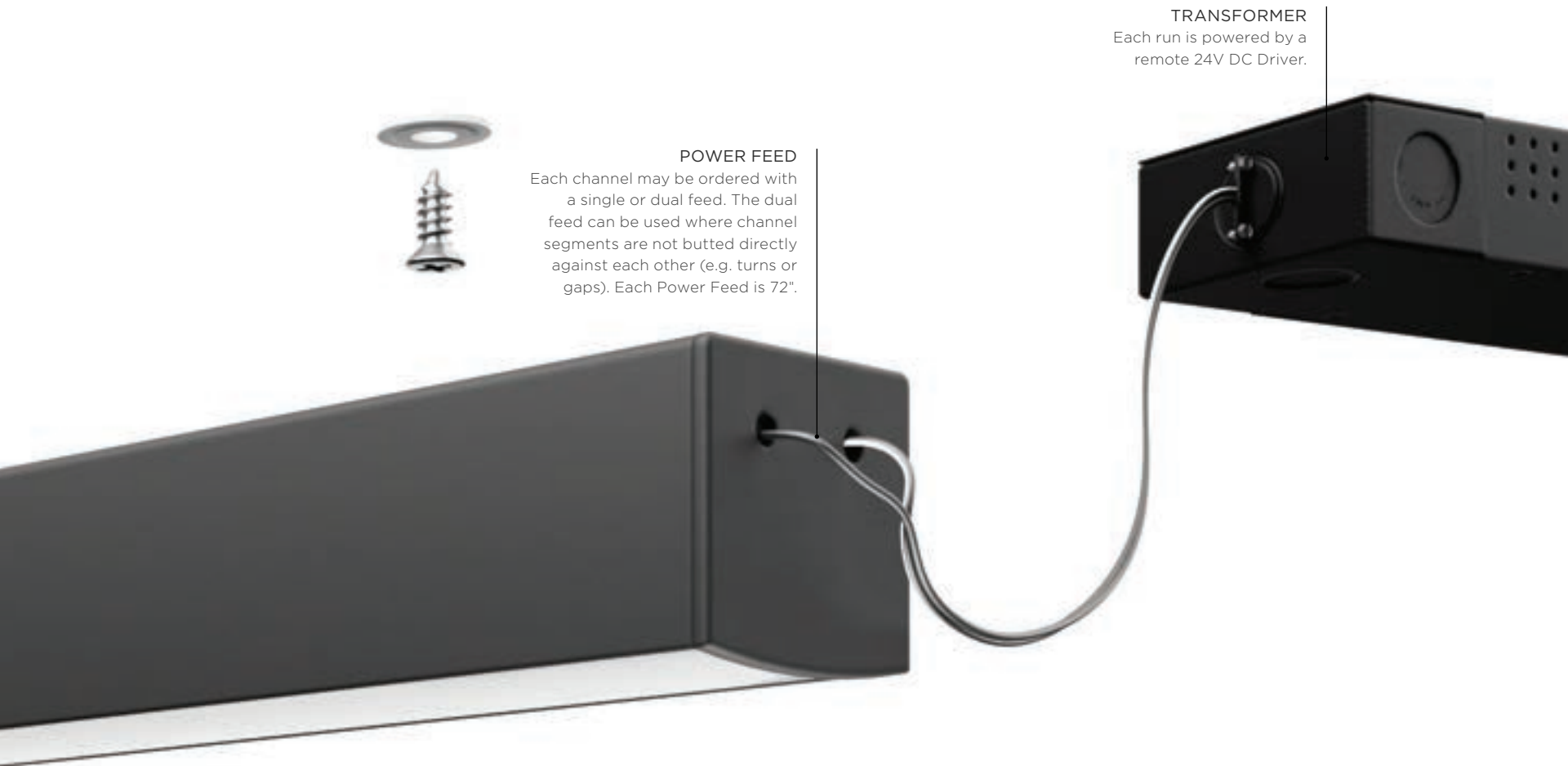

**TRANSFORMER**  
Each run is powered by a remote 24V DC Driver.

**POWER FEED**

Each channel may be ordered with a single or dual feed. The dual feed can be used where channel segments are not butted directly against each other (e.g. turns or gaps). Each Power Feed is 72".

**HOW TO ORDER**

**LED CHANNELS:**

Surface Mount (ESSF0606), 45 Degree (ES45) and Recessed (ESRW0606): Specify the length to the exact inch as required

Shallow Surface Mount (ESSF0604): Specify the length by referencing the Length Chart on the Specification Sheet

**LED TAPE:**

Order by the foot

Feld-cuttable every 1.3 inches for install flexibility (3.3" for Warm Dim)

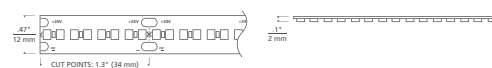

**CONTINUOUS RUNS UP TO 50 FEET:**

A concealed Channel Joiner is included with any channel greater than 8' for simple and seamless connectivity. Not applicable with the Shallow Surface Mount (ESSF0604)

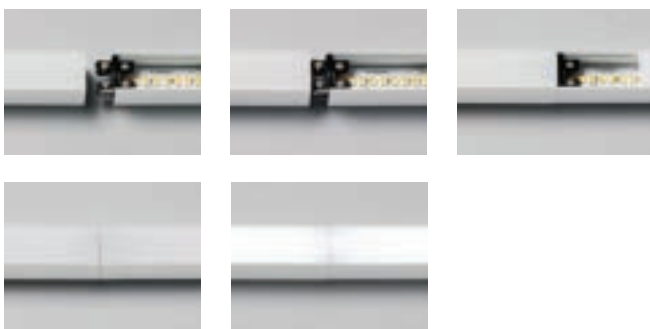

**POWER FEEDS:**

Specify 1 Power Feed when wiring a single fixture (even with multiple segments)



Specify 2 Power Feeds when wiring multiple fixtures together from a single power supply (e.g. two fixtures connected via wire nuts, splice box, j-box, etc.)





ESSENCE SURFACE MOUNT 0604 WARM DIM, SATIN ALUMINUM  
GUNNAR PENDANT, WHITE / SATIN HAZE



# PRODUCT SPECIFICATIONS

	U-SERIES			P-SERIES				WARM DIM	
	STATIC WHITE			STATIC WHITE					
 SURFACE/RECESSED MOUNT 0606 45 DEGREE	DELIVERED LUMENS/FT	625	375	225	625	375	225	170	250
	WATTS/FT	7.3	4.6	2.5	7.3	4.6	2.5	1.9	3.4
	EFFICACY	86	82	90	86	82	90	89	75
 SURFACE MOUNT 0604	DELIVERED LUMENS/FT	725	450	275	725	450	275	190	300
	WATTS/FT	7.3	4.6	2.5	7.3	4.6	2.5	1.9	3.4
	EFFICACY	99	98	110	99	98	110	100	90
 LED TAPE	DELIVERED LUMENS/FT	800	500	300	800	500	300	200	350
	WATTS/FT	7.3	4.6	2.5	7.3	4.6	2.5	1.9	3.4
	EFFICACY	110	109	120	110	109	120	105	104
<b>CCT OPTIONS</b>	2700K, 3000K, or 3500K			2400K, 2700K, 3000K, 3500K, or 4200K				3000K-1800K	
<b>COLOR CONSISTENCY</b>	1-step			2-step				2-Step	
<b>CRI</b>	97+			95+				95+	
<b>Rf (FIDELITY)</b>	95+			90+				90+	
<b>Rg (GAMUT)</b>	100			95-105				95	
<b>VOLTAGE</b>	Channels and LED Tape: 24VDC input Power Supplies: 120V or 277VAC input   24VDC output								
<b>DIMMING</b>	Standard phase dimming (down to 0.2%)   MLV dimming (down to 0.2%) 0-10V dimming (down to 5%)   Lutron Hi-lume EcoSystem/3-wire (down to 0.1%)							Standard phase dimming (down to 0.2%)   0-10V dimming (down to 5%)	
<b>POWER SUPPLY</b>	Constant voltage with +.9 power factor and +80% efficiency. Class 2 up to 100W.								
<b>LENS</b>	Frosted, White								
<b>CONSTRUCTION</b>	Channel: Extruded Aluminum   Lens: Extruded Acrylic   End caps: Die-Cast Zinc								
<b>FINISH</b>	Black, Satin Aluminum, or White (paintable)								
<b>GENERAL LISTING</b>	ETL Listed Class 2. Damp Listed. Suitable for closets/storage spaces.								
<b>CALIFORNIA TITLE 24</b>	Registered CEC appliance database. Can be used to comply with CEC 2019 title 24 part 6, excluding MLV.								
<b>L70</b>	50,000 hours min								
<b>WARRANTY</b>	Channels 10 years; Power Supplies 5 years								

Data in chart reflects 3000K values with Frosted Lens. For White Lens, multiply output by 0.80.



ESSENCE RECESSED FLANGED 0606 U-SERIES STATIC WHITE, SATIN ALUMINUM

# SURFACE MOUNT 0604

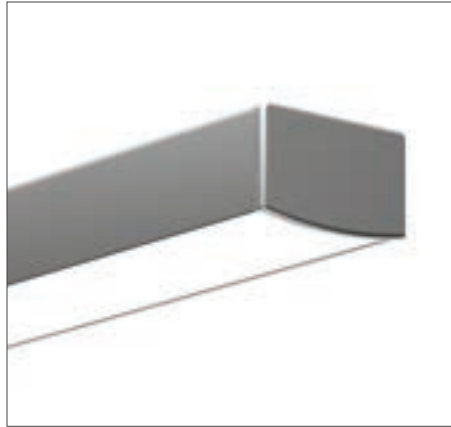

SATIN ALUMINUM  
shown with white lens



BLACK  
shown with white lens



WHITE (PAINTABLE)  
shown with white lens

## FEATURES

- Ideal for applications in need of an ultra-shallow profile
- Seamless and hidden hardware for a clean aesthetic
- Highest efficacy with LEDs engineered close to the lens
- White Lens eliminates LED pixelation with Static White LEDs, while pixelation is visible with Warm Dim LEDs
- Frosted Lens maximizes light output, while pixelation is visible
- Uninterrupted illumination up to 96 inches
- Reference Length Chart on Specification Sheet for precise ordering dimensions

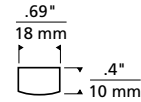

## ORDERING GRIDS

### SURFACE MOUNT 0604 U-SERIES STATIC WHITE

(1-STEP)

PRODUCT	NOMINAL LENGTH IN INCHES	OUTPUT/FT <sup>1</sup>	CRI/CCT	LENS	FINISH	POWER FEED
ESSF0604U ESSENCE SURFACE MOUNT 0.6"W X 0.4"H U-SERIES (1-STEP)	6-96 (SEE OVERALL LENGTH CHART)	275 275 LM/FT	927 97 CRI, 2700K	F FROSTED	B BLACK	1 1 FEED
		450 450 LM/FT	930 97 CRI, 3000K	W WHITE	A SATIN ALUMINUM	2 2 FEEDS
		725 725 LM/FT	935 97 CRI, 3500K		W WHITE (PAINTABLE)	
<b>ESSF0604U</b>						

<sup>1</sup>Frosted Lens output shown. For White Lens multiply output by 0.80.

### SURFACE MOUNT 0604 P-SERIES STATIC WHITE

(2-STEP)

PRODUCT	NOMINAL LENGTH IN INCHES	OUTPUT/FT <sup>1</sup>	CRI/CCT	LENS	FINISH	POWER FEED
ESSF0604P ESSENCE SURFACE MOUNT 0.6"W X 0.4"H P-SERIES (2-STEP)	6-96 (SEE OVERALL LENGTH CHART)	190 190 LM/FT	924 95 CRI, 2400K <sup>2</sup>	F FROSTED	B BLACK	1 1 FEED
		275 275 LM/FT	927 95 CRI, 2700K	W WHITE	A SATIN ALUMINUM	2 2 FEEDS
		450 450 LM/FT	930 95 CRI, 3000K		W WHITE (PAINTABLE)	
		725 725 LM/FT	935 95 CRI, 3500K			
			942 95 CRI, 4200K <sup>3</sup>			
<b>ESSF0604P</b>						

<sup>1</sup>Frosted Lens output shown. For White Lens multiply output by 0.80.

<sup>2</sup>924 - 190 and 275 lm/ft only.

<sup>3</sup>942 - Not available 190 lm/ft.

### SURFACE MOUNT 0604 WARM DIM<sup>1</sup>

(2-STEP)

PRODUCT	LENGTH IN INCHES	OUTPUT/FT <sup>1,2</sup>	CRI/CCT	LENS	FINISH	POWER FEED
ESSF0606D ESSENCE SURFACE MOUNT <sup>1</sup> 0.6"W X 0.4"H	6-96 (SEE OVERALL LENGTH CHART)	300 300 LM/FT	9W3018 95 CRI, WARM DIM 3000K-1800K	F FROSTED	B BLACK	1 1 FEED
				W WHITE	A SATIN ALUMINUM	2 2 FEEDS
<b>ESSF0604D</b>						

<sup>1</sup>Pixelation may be visible.

<sup>2</sup>Frosted Lens output shown. For White Lens multiply output by 0.80.



# SURFACE MOUNT 0606

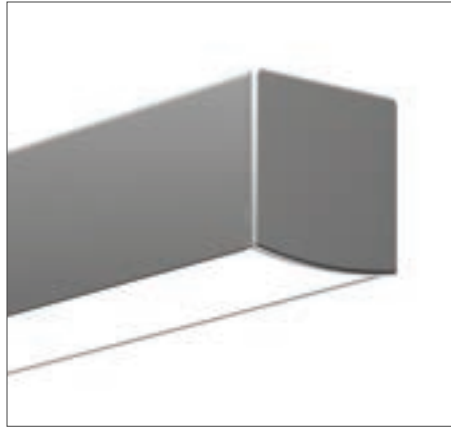

SATIN ALUMINUM  
shown with white lens



BLACK  
shown with white lens



WHITE (PAINTABLE)  
shown with white lens

## FEATURES

- Most versatile solution for surface mount applications
- Premium illumination for shelving, coves, under cabinet and task/accent lighting
- White Lens eliminates LED pixelation with Static White and Warm Dim LEDs
- Frosted Lens eliminates LED pixelation with Static White LEDs, while pixelation is visible with Warm Dim LEDs
- Seamless and hidden hardware for a clean aesthetic
- Uninterrupted illumination up to 600 inches, order by the exact inch

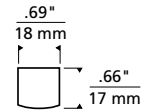

## ORDERING GRIDS

### SURFACE MOUNT 0606 U-SERIES STATIC WHITE

(1-STEP)

PRODUCT	LENGTH IN INCHES	OUTPUT/FT <sup>1</sup>	CRI/CCT	LENS	FINISH	POWER FEED
ESSF0606U ESSENCE SURFACE MOUNT 0.6"W X 0.6"H U-SERIES (1-STEP)	6-480 (1" INCREMENTS)	225 225 LM/FT	927 97 CRI, 2700K	F FROSTED	B BLACK	1 1 FEED
		375 375 LM/FT <sup>2</sup>	930 97 CRI, 3000K	W WHITE	A SATIN ALUMINUM	2 2 FEEDS
		625 625 LM/FT <sup>3</sup>	935 97 CRI, 3500K		W WHITE (PAINTABLE)	

#### ESSF0606U

<sup>1</sup>Frosted Lens output shown. For White Lens multiply output by 0.80.

<sup>2</sup>375 - Output 240" (20 ft) max length.

<sup>3</sup>625 - Output 156" (13 ft) max length.

### SURFACE MOUNT 0606 P-SERIES STATIC WHITE

(2-STEP)

PRODUCT	LENGTH IN INCHES	OUTPUT/FT <sup>1</sup>	CRI/CCT	LENS	FINISH	POWER FEED
ESSF0606P ESSENCE SURFACE MOUNT 0.6"W X 0.6"H P-SERIES (2-STEP)	6-600 (1" INCREMENTS)	170 170 LM/FT	924 95 CRI, 2400K <sup>5</sup>	F FROSTED	B BLACK	1 1 FEED
		225 225 LM/FT <sup>2</sup>	927 95 CRI, 2700K	W WHITE	A SATIN ALUMINUM	2 2 FEEDS
		375 375 LM/FT <sup>3</sup>	930 95 CRI, 3000K		W WHITE (PAINTABLE)	
		625 625 LM/FT <sup>4</sup>	935 95 CRI, 3500K			
		924 95 CRI, 4200K <sup>6</sup>				

#### ESSF0606P

<sup>1</sup>Frosted Lens output shown. For White Lens multiply output by 0.80.

<sup>2</sup>225 - Output 480" (40 ft) max length

<sup>3</sup>375 - Output 240" (20 ft) max length.

<sup>4</sup>625 - Output 156" (13 ft) max length.

<sup>5</sup>924 - 170 and 225 lm/ft only.

<sup>6</sup>942 - Not available in 170 lm/ft.

### SURFACE MOUNT 0606 WARM DIM<sup>1</sup>

(2-STEP)

PRODUCT	LENGTH IN INCHES	OUTPUT/FT <sup>1</sup>	CRI/CCT	LENS	FINISH	POWER FEED
ESSF0606D ESSENCE SURFACE MOUNT 0.6"W X 0.6"H	6-180 (1" INCREMENTS)	250 250 LM/FT	9W3018 95 CRI, WARM DIM 3000K-1800K	F FROSTED	B BLACK	1 1 FEED
				W WHITE	A SATIN ALUMINUM	2 2 FEEDS

#### ESSF0606D

<sup>1</sup>Frosted Lens output shown. For White Lens multiply output by 0.80.

## RECESSED 0606



SATIN ALUMINUM  
shown with white lens



BLACK  
shown with white lens



WHITE (PAINTABLE)  
shown with white lens

### FEATURES

- Designed for recessed millwork applications such as cabinets, bookshelves and closets or tile installations common throughout bathrooms and kitchens
- White Lens eliminates LED pixelation with Static White and Warm Dim LEDs
- Frosted Lens eliminates LED pixelation with Static White LEDs, while pixelation is visible with Warm Dim LEDs
- Uninterrupted illumination up to 600 inches, order by exact inch

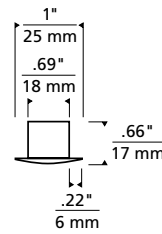

### ORDERING GRIDS

#### RECESSED FLANGED CABINET/MILLWORK 0606 U-SERIES STATIC WHITE

(1-STEP)

PRODUCT	LENGTH IN INCHES	OUTPUT/FT <sup>2</sup>	CRI/CCT	LENS	FINISH	POWER FEED
ESRW0606U ESSENCE RECESSED FLANGED CABINET/MILLWORK <sup>1</sup> 0.6"W X 0.6"H U-SERIES (1-STEP)	6-480 (1" INCREMENTS)	225 225 LM/FT	927 97 CRI, 2700K	F FROSTED	B BLACK	1 1 FEED
		375 375 LM/FT <sup>3</sup>	930 97 CRI, 3000K	W WHITE	A SATIN ALUMINUM	2 2 FEEDS
		625 625 LM/FT <sup>4</sup>	935 97 CRI, 3500K		W WHITE (PAINTABLE)	

#### ESRW0606U

<sup>1</sup>Not intended for drywall application.

<sup>2</sup>Frosted Lens output shown. For White Lens multiply output by 0.80.

<sup>3</sup>375 - Output 240" (20 ft) max length.

<sup>4</sup>625 - Output 156" (13 ft) max length.

#### RECESSED FLANGED CABINET/MILLWORK 0606 P-SERIES STATIC WHITE

(2-STEP)

PRODUCT	LENGTH IN INCHES	OUTPUT/FT <sup>2</sup>	CRI/CCT	LENS	FINISH	POWER FEED
ESRW0606P ESSENCE RECESSED FLANGED CABINET/MILLWORK <sup>1</sup> 0.6"W X 0.6"H P-SERIES (2-STEP)	6-600 (1" INCREMENTS)	170 170 LM/FT	924 95 CRI, 2400K <sup>6</sup>	F FROSTED	B BLACK	1 1 FEED
		225 225 LM/FT <sup>3</sup>	927 95 CRI, 2700K	W WHITE	A SATIN ALUMINUM	2 2 FEEDS
		375 375 LM/FT <sup>4</sup>	930 95 CRI, 3000K		W WHITE (PAINTABLE)	
		625 625 LM/FT <sup>5</sup>	935 95 CRI, 3500K			
			942 95 CRI, 4200K <sup>7</sup>			

#### ESRW0606P

<sup>1</sup>Not intended for drywall application.

<sup>2</sup>Frosted Lens output shown. For White Lens multiply output by 0.80.

<sup>3</sup>225 - Output 480" (40 ft) max length

<sup>4</sup>375 - Output 240" (20 ft) max length.

<sup>5</sup>625 - Output 156" (13 ft) max length.

<sup>6</sup>924 - 170 and 225 lm/ft only.

<sup>7</sup>942 - Not available in 170 lm/ft.

#### RECESSED FLANGED CABINET/MILLWORK 0606 WARM DIM

(2-STEP)

PRODUCT	LENGTH IN INCHES	OUTPUT/FT <sup>2</sup>	CRI/CCT	LENS	FINISH	POWER FEED
ESRW0606D ESSENCE RECESSED FLANGED CABINET/MILLWORK <sup>1</sup> 0.6"W X 0.6"H	6-180 (1" INCREMENTS)	250 250 LM/FT	9W3018 95 CRI, WARM DIM	F FROSTED	B BLACK	1 1 FEED
			3000K-1800K	W WHITE	A SATIN ALUMINUM	2 2 FEEDS

#### ESRW0606D

250

9W3018

<sup>1</sup>Not intended for drywall application.

<sup>2</sup>Frosted Lens output shown. For White Lens multiply output by 0.80.

# 45 DEGREE



SATIN ALUMINUM  
shown with white lens



BLACK  
shown with white lens



WHITE (PAINTABLE)  
shown with white lens

## FEATURES

- Ideal for front lighting, bookshelves, pantries, closets and under cabinets to illuminate backsplashes
- White Lens eliminates LED pixelation with Static White and Warm Dim LEDs
- Frosted Lens eliminates LED pixelation with Static White LEDs, while pixelation is visible with Warm Dim LEDs
- Seamless and hidden hardware for a clean aesthetic
- Uninterrupted illumination up to 600 inches, order by the exact inch

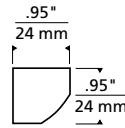

## ORDERING GRIDS

### 45 DEGREE U-SERIES STATIC WHITE

(1-STEP)

SYSTEM	LENGTH IN INCHES	OUTPUT/FT <sup>1</sup>	CRI/CCT	LENS	FINISH	POWER FEED
ES45U ESSENCE 45 DEGREE U-SERIES (1-STEP)	6-480 (1" INCREMENTS)	225 225 LM/FT	927 97 CRI, 2700K	F FROSTED	B BLACK	1L 1 FEED LEFT
		375 375 LM/FT <sup>2</sup>	930 97 CRI, 3000K	W WHITE	A SATIN ALUMINUM	1R 1 FEED RIGHT
		625 625 LM/FT <sup>3</sup>	935 97 CRI, 3500K		W WHITE (PAINTABLE)	2 2 FEEDS

#### ES45U

<sup>1</sup>Frosted Lens output shown. For White Lens multiply output by 0.80.

<sup>2</sup>375 - Output 240" (20 ft) max length.

<sup>3</sup>625 - Output 156" (13 ft) max length.

### 45 DEGREE P-SERIES STATIC WHITE

(2-STEP)

SYSTEM	LENGTH IN INCHES	OUTPUT/FT <sup>1</sup>	CRI/CCT	LENS	FINISH	POWER FEED
ES45P ESSENCE 45 DEGREE P-SERIES (2-STEP)	6-600 (1" INCREMENTS)	170 170 LM/FT	924 95 CRI, 2400K <sup>5</sup>	F FROSTED	B BLACK	1L 1 FEED LEFT
		225 225 LM/FT <sup>2</sup>	927 95 CRI, 2700K	W WHITE	A SATIN ALUMINUM	1R 1 FEED RIGHT
		375 375 LM/FT <sup>3</sup>	930 95 CRI, 3000K		W WHITE (PAINTABLE)	2 2 FEEDS
		625 625 LM/FT <sup>4</sup>	935 95 CRI, 3500K			
			942 95 CRI, 4200K <sup>6</sup>			

#### ES45P

<sup>1</sup>Frosted Lens output shown. For White Lens multiply output by 0.80.

<sup>2</sup>225 - Output 480" (40 ft) max length

<sup>3</sup>375 - Output 240" (20 ft) max length.

<sup>4</sup>625 - Output 156" (13 ft) max length.

<sup>5</sup>924 - 170 and 225 lm/ft only.

<sup>6</sup>942 - Not available in 170 lm/ft.

### 45 DEGREE WARM DIM<sup>1</sup>

(2-STEP)

PRODUCT	LENGTH IN INCHES	OUTPUT/FT <sup>1</sup>	CRI/CCT	LENS	FINISH	POWER FEED
ES45D ESSENCE 45 DEGREE	6-180 (1" INCREMENTS)	250 250 LM/FT	9W3018 95 CRI, WARM DIM 3000K-1800K	F FROSTED	B BLACK	1L 1 FEED LEFT
				W WHITE	A SATIN ALUMINUM	1R 1 FEED RIGHT
					W WHITE (PAINTABLE)	2 2 FEEDS

#### ES45D

<sup>1</sup>Frosted Lens output shown. For White Lens multiply output by 0.80.

## U SERIES LED TAPE



### FEATURES

- Ideal for premium illumination needs in areas where the light source is not visible and a channel will not fit
- 1-step color consistency, CRI 97+, R9 95+, Rf 95+, Rg 100
- Tight LED pitch (72 LEDs/ft)
- Tape field cuttable in 1.3 inch increments, ordered by the foot
- Includes 3M™ Double Sided Tape for robust mounting
- Copper substrate minimizes voltage drop for consistent brightness along run

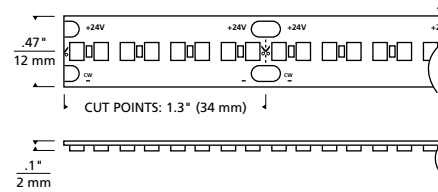

### ORDERING GRIDS

#### LED TAPE U-SERIES

(1-STEP)

PRODUCT	LENGTH IN FEET	OUTPUT/FT	CRI/CCT
ESLTU ESSENCE LED TAPE U-SERIES (1-STEP)	<b>1-40</b>	<b>300</b> 300 LM/FT	<b>927</b> 97 CRI, 2700K
	(1 FT INCREMENTS)	<b>500</b> 500 LM/FT <sup>1</sup>	<b>930</b> 97 CRI, 3000K
		<b>800</b> 800 LM/FT <sup>2</sup>	<b>935</b> 97 CRI, 3500K

#### ESLTU

<sup>1</sup>500 - Output 20 ft max length.

<sup>2</sup>800 - Output 13 ft max length.

## P SERIES LED TAPE



### FEATURES

- Ideal for illumination needs in areas where the light source is not visible and a channel will not fit
- 2-step color consistency, CRI 95+, R9 90+, Rf 90+, Rg 95-105
- Tight LED pitch (72 LEDs/ft)
- Tape field-cuttable in 1.3 inch increments, ordered by the foot
- Includes 3M™ Double Sided Tape for robust mounting
- Copper substrate minimizes voltage drop for consistent brightness along run

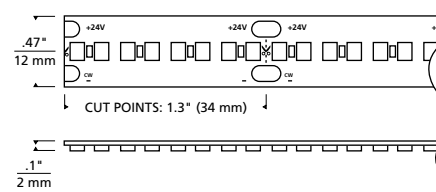

### ORDERING GRIDS

#### LED TAPE P-SERIES

(2-STEP)

PRODUCT	LENGTH IN FEET	OUTPUT/FT	CRI/CCT
ESLTP ESSENCE LED TAPE P-SERIES (2-STEP)	1-50 (1 FT INCREMENTS)	200 200 LM/FT	924 95 CRI, 2400K <sup>4</sup>
		300 300 LM/FT <sup>1</sup>	927 95 CRI, 2700K
		500 500 LM/FT <sup>2</sup>	930 95 CRI, 3000K
		800 800 LM/FT <sup>3</sup>	935 95 CRI, 3500K
			942 95 CRI, 4200K <sup>5</sup>

#### ESLTP

- <sup>1</sup>300 - Output 40 ft max length.
- <sup>2</sup>500 - Output 20 ft max length.
- <sup>3</sup>800 - Output 13 ft max length.
- <sup>4</sup>924 - 200 and 300 lm/ft only.
- <sup>5</sup>942 - Not available in 200 lm/ft.

## WARM DIM LED TAPE



### FEATURES

- Ideal for premium Warm Dim illumination needs in areas where the light source is not visible and a channel will not fit
- 2-step color consistency, CRI 95+, R9 90+, Rf 90+, Rg 95
- Tight LED pitch (Warm Dim 52 LEDs/ft )
- Tape field cuttable in 3.3 inch increments ordered by the foot
- Includes 3M™ Double Sided Tape for robust mounting
- Copper substrate minimizes voltage drop for consistent brightness along run

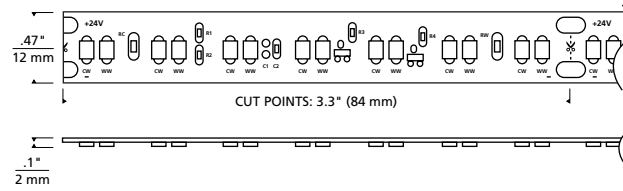

### ORDERING GRIDS

#### LED TAPE WARM DIM

(2-STEP)

PRODUCT	LENGTH IN FEET	OUTPUT/FT	CRI/CCT
ESLTD ESSENCE LED TAPE	1-15 (1 FT INCREMENTS)	350 350 LM/FT	9W3018 95 CRI, WARM DIM, 3000K-1800K
<b>ESLTD</b>		<b>350</b>	<b>9W3018</b>



ESSENCE RECESSED 0604 U-SERIES STATIC WHITE, WHITE  
WIT LINEAR 5-LIGHT SUSPENSION, AGED BRASS

# POWER SUPPLIES



60W



100W

## REMOTE POWER SUPPLY PHASE DIMMING<sup>1</sup>

Remote Power Supply for Phase Dimming down to 0.2%. 120V input voltage with 24VDC output available in 60W and 100W. Enclosure included.

### ORDERING INFORMATION

ESPR06024ELV120 60W POWER SUPPLY REMOTE PHASE DIMMING  
 ESPR10024ELV120 100W POWER SUPPLY REMOTE PHASE DIMMING

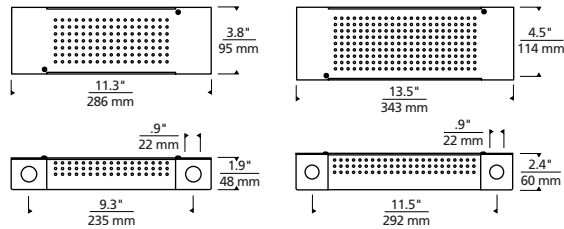

60W PHASE DIMMING ENCLOSURE

100W PHASE DIMMING ENCLOSURE



60W



100W

## REMOTE POWER SUPPLY 0-10V<sup>1</sup>

Remote Power Supply for 0-10V dimming down to 5%. Universal input 120V-277V with 24VDC output available in 60W and 100W. Enclosure included.

### ORDERING INFORMATION

ESPR06024010120-277 60W POWER SUPPLY REMOTE 0-10V  
 ESPR10024010120-277 100W POWER SUPPLY REMOTE 0-10V

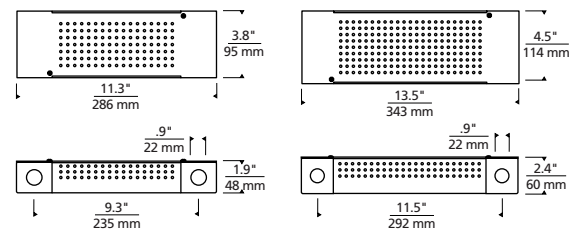

60W 0-10V ENCLOSURE

100W 0-10V ENCLOSURE



## REMOTE TRANSFORMER MLV 5%

Remote Power Supply for MLV dimming down to 5%. 120V input voltage with 24VDC output available in 60W and 100W. Available for Static White LED Tape only. 60W Load Min/Max: 12W/42W. 100W Load Min/Max: 20W/70W. Enclosure included.

### ORDERING INFORMATION

ESPR06024MLV120 60W POWER SUPPLY REMOTE MLV<sup>1</sup>  
 ESPR10024MLV120 100W POWER SUPPLY REMOTE MLV<sup>1</sup>

<sup>1</sup>MLV not available with Warm Dim.

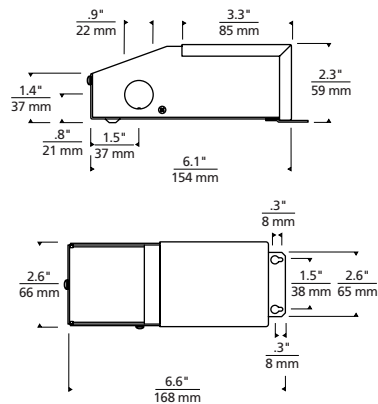

60W AND 100W MLV ENCLOSURE



## REMOTE TRANSFORMER MLV 0.2%

Remote Power Supply for MLV dimming down to 0.2%. 120V input voltage with 24VDC output available in 48W and 100W. 48W Load Max: 33W. 100W Load Max: 70W. Enclosure included.

### ORDERING INFORMATION

ESPR04824JMLV120 48W POWER SUPPLY MLV 0.2%<sup>1</sup>  
 ESPR10024JMLV120 100W POWER SUPPLY MLV 0.2%<sup>1</sup>

<sup>1</sup>JMLV not available with Warm Dim.

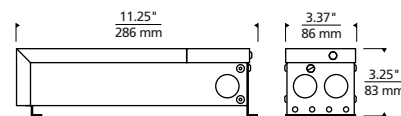

48W AND 100W MLV ENCLOSURE



## REMOTE POWER SUPPLY LUTRON HI-LUME ECOSYSTEM/3-WIRE 0.1%<sup>1</sup>

Remote Lutron Hi-lume Power Supply for EcoSystem or 3-wire compatibility with dimming down to 0.1%. Available for Static White LED Tape only. Universal input 120V-277V with 24VDC output available in 100W. Enclosure included.

### ORDERING INFORMATION

ESPR10024HLECO120-277 100W POWER SUPPLY LUTRON HI-LUME ECOSYSTEM/3-WIRE<sup>1</sup>

<sup>1</sup>HLECO not available with Warm Dim.

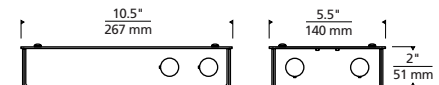

100W ECOSYSTEM/3-WIRE ENCLOSURE



## ACCESSORIES



### ESSENCE CHANNEL MOUNTING CLIP, SURFACE FIXED

Included with fixture and to be used every 2 feet. Assembles to the mounting surface with wood screw (included) allowing fixture to snap into place with a secure hold. Once fixture is installed, the Surface Fixed Mounting Clip is completely concealed within the rear channel of fixture. Mounting to surfaces other than wood, requires alternate screws/anchors (not included). For wall mount with fixtures oriented vertically, use Double-Sided Tape.

**ORDERING INFORMATION**  
**ESCLPSF06** SURFACE MOUNT 0604 AND 0606 (0.6" DIA.)  
**ESCLPSF10** 45 DEGREE (0.8" DIA.)

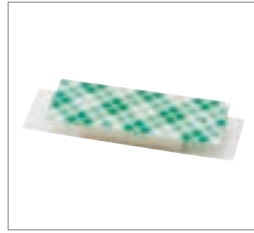
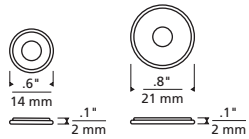

### ESSENCE CHANNEL MOUNTING DOUBLE-SIDED TAPE

Included with fixture and to be used every foot. Easy to apply, high-bond tape used as an alternative mounting solution for a secure hold. Once fixture is installed, the Double-Sided Tape is completely concealed within the rear channel of the fixture.

**ORDERING INFORMATION**  
**ESTPDS75**

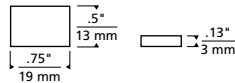

### WIRE MANAGEMENT CLIP

Designed with simplicity to help route and conceal wiring. Includes 10 clips and screws.

**ORDERING INFORMATION**  
**ESLTCLPJ**

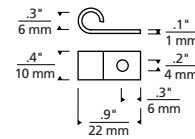

### SPLICE BOX

Used for housing low-voltage wire connections.

**ORDERING INFORMATION**  
**ESLTSBB** BLACK  
**ESLTSBW** WHITE

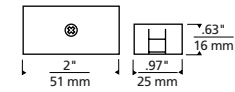

### LED TAPE-TO-WIRE CONNECTOR

Connectors used to power feed a run of LED tape. Compatible with 14-20 AWG wire (not included).

**ORDERING INFORMATION**  
**ESLTCTW12-2**

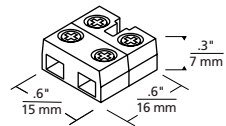

### LED TAPE-TO-TAPE CONNECTOR

Connectors used to extend a run of LED tape.

**ORDERING INFORMATION**  
**ESLTCTT12-2**

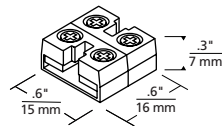

# ESG

SUPPORTING CUSTOMERS AND SALES REPRESENTATIVES WITH SUPERIOR SERVICE AND SOLUTIONS

At Tech Lighting we know that our success is based on delivering 5-Star customer service. We offer some of the best designed and engineered products in the lighting industry with dedicated sales and customer service support - lean on us to get the job done.

# ENHANCED SOLUTIONS GROUP

DEDICATED CUSTOMER SALES & SERVICE TEAM

Experts on the Complete Tech Lighting Portfolio

- Specification details and cross-over references
- Installation techniques and troubleshooting
- Production, scheduling and delivery oversight
- Pricing
- Custom capabilities

Highly Available, Responsive & Responsible

- Direct Access: [ESG@visualcomfortco.com](mailto:ESG@visualcomfortco.com)
- Act with urgency. Constant communication. No surprises.



[ESG@visualcomfortco.com](mailto:ESG@visualcomfortco.com)

## SPECIAL SERVICES



### QUICK SHIP PROGRAM

Lighting is oftentimes one of the last things to be installed on a project. Our goal is to ship ANY ESSENCE made-to-order product in 5 days or less

Receive your quotes turned around in less than 24 hours



### FREE SAMPLES IN 48 HOURS

We appreciate that nothing validates a design like seeing a physical sample

24" length sample includes cord and plug for easy demonstration

48 hour turn-around time on ANY ESSENCE part number (includes cord & plug for easy demonstration)

Samples are FREE for 60 days



### SHOP DRAWINGS

ESG can make specifying ESSENCE easier with detailed shop drawings



### LIGHTING CALCULATIONS

Download our .ies files from our online library or utilize our team of experts to run lighting calculations to ensure you are getting the required light levels



### FIXTURE SCHEDULE LABELS

Provide us with your fixture schedule and we will be happy to label each box aiding in on-site organization and installation



### CUSTOM SOLUTIONS

Contact us for requests on custom project requests, including less than 1" increment lengths



ESSENCE SURFACE MOUNT 0604 WARM DIM, SATIN ALUMINUM  
KONOS PENDANT, WHITE / SATIN HAZE



7400 Linder Ave.  
Skokie, IL 60077  
T 847 410 4400  
W [techlighting.com](http://techlighting.com)

VISUAL COMFORT & Co.

921TLESENCE21

SHOWN ON COVER:  
ESSENCE RECESSED FLANGED 0606 STATIC WHITE, BLACK  
CALUMN PENDANT, NIGHTSHADE BLACK