



# SAVOY HOUSE



## ESSENTIALS

JANUARY 2023





## SAVOY HOUSE ESSENTIALS

---

The Savoy House Essentials collection was designed with modern American home décor style in mind.

Blurring the boundaries of classic and traditional, modern and contemporary, Essentials fixtures effortlessly mix and match allowing you to create a refined style. Each piece is crafted and thoughtfully chosen to work well on its own or together for a complementary companion look.

Offered in up to five finishes, including our most popular matte black, Essentials is perfect for today's open-concept home designs. Designed with the same high quality and attention to detail that you have come to expect from Savoy House, customers can choose with confidence when they choose to purchase from the Savoy House Essentials collection.

# CONTENTS

## ALPHABETICAL LISTING BY FAMILY:

Akron .....	172	Foster .....	236	Pendleton.....	207
Alden .....	142	Franklin .....	186	Penrose.....	134, 206
Ballas .....	254	Fremont .....	218	Pike.....	232
Bally .....	186	Galea .....	138	Polson .....	213
Becker .....	166	Garnet .....	248	Powell .....	88, 228
Benson .....	130, 205	Genry .....	10	Reid .....	188
Berg .....	144, 207	Glenn .....	238	Renzo.....	4
Brody .....	82	Gordon .....	258	Rhodes .....	214
Calhoun.....	100, 206, 252	Hampton .....	246	Rohe.....	8
Cameron.....	90, 224, 286	Haynes .....	34	Sacramento.....	256
Capra .....	282	Herndon .....	110, 185, 246, 296	Salerno .....	72
Carlton .....	94, 181	Jasmine.....	74	Seagram .....	140
Carson.....	247, 262	Jefferson.....	216	Seville .....	62
Chantilly .....	250	Joffree .....	212	Stirling .....	169
Chival .....	185	Kaden .....	284	Stockton.....	192
Clifton .....	233	Kane .....	297	Torino.....	78
Colton .....	108, 246, 294	Kent .....	132, 204	Townsend.....	112
Como.....	210	Kenyon .....	234	Vale.....	280
Crawford.....	96, 237	Lakewood.....	50, 272	Ventari.....	16
Cristofer .....	38	Lyrique.....	68, 194	Vintage .....	185
Crosby .....	46, 266	Mansfield .....	164	Washburn.....	225
Dakota.....	244	Marco.....	190	Watkins.....	196
Dawson.....	235	Marshall .....	278	Waverly.....	239
Denton .....	126	Mason .....	260	Westbourne.....	169
Destin .....	226	Melrose.....	208, 246, 288	Whitney.....	292
Devon .....	227	Middleton.....	54	Willis.....	146
Diplomat.....	128	Monroe .....	220	Willmar .....	230
Drake .....	245, 247	Morland.....	242	Winfield.....	22
Edgewood .....	86	Newport .....	80	Wright .....	42, 181, 264
Elise .....	247, 297	Octave.....	104, 247, 268	Yates .....	296
Fallon.....	30	Owen.....	243	York .....	240
Falster .....	26	Palladian.....	124		

# CONTENTS

---

	Collections ..... 4
	Ceiling ..... 188
	Wall Lighting ..... 210
	Pour Le Bain / Vanity / Glass ..... 248
	Finish Guide / Index ..... 298

# RENZO

---



Includes 12" & 6" extensions - additional stems available - 7-EXT

---

4 SAVOYHOUSE.COM | 800 801 1621

# RENZO



Dual Mount Hanging System

**A. 7-9044-3-89**  
 3-Light Pendant  
 Matte Black Finish  
 16"W x 12"H  
 Adj H 12" - 66"  
 3E 60W  
 Clear Crystal

**B. 7-9046-4-89**  
 4-Light Pendant  
 Matte Black Finish  
 22"W x 12"H  
 Adj H 12" - 66"  
 4E 60W  
 Clear Crystal

**C. 7-9046-4-322**  
 4-Light Pendant  
 Warm Brass Finish  
 22"W x 12"H  
 Adj H 12" - 66"  
 4E 60W  
 Clear Crystal

**D. 7-9044-3-322**  
 3-Light Pendant  
 Warm Brass Finish  
 16"W x 12"H  
 Adj H 12" - 66"  
 3E 60W  
 Clear Crystal

# RENZO



Includes 12" & 6" extensions - additional stems available - 7-EXT

6 SAVOYHOUSE.COM | 800 801 1621



# RENZO



Dual Mount Hanging System



**A. 7-9048-6-89**  
6-Light Pendant  
Matte Black Finish  
28"W x 12"H  
Adj H 12" - 66"  
6E 60W  
Clear Crystal

**B. 7-9048-6-322**  
6-Light Pendant  
Warm Brass Finish  
28"W x 12"H  
Adj H 12" - 66"  
6E 60W  
Clear Crystal

# ROHE

---

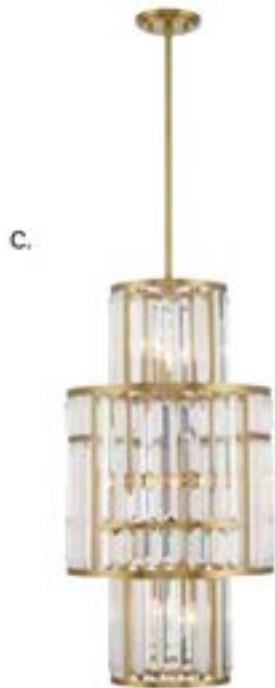

Includes 12' & 6" extensions - additional stems available - 7-EXTLG

---

8 SAVOYHOUSE.COM | 800 801 1621

# ROHE



Dual Mount Hanging System

**A. 7-2224-5-89**  
 5-Light Pendant  
 Matte Black Finish  
 26"W x 19-1/4"H  
 Adj H 19-1/4" - 73-1/4"  
 5C 60W  
 Clear Crystal

**B. 3-2226-8-89**  
 8-Light Pendant  
 Matte Black Finish  
 15-3/4"W x 31"H  
 Adj H 31" - 85"  
 8C 60W  
 Clear Crystal

**C. 3-2226-8-322**  
 8-Light Pendant  
 Warm Brass Finish  
 15-3/4"W x 31"H  
 Adj H 31" - 85"  
 8C 60W  
 Clear Crystal

**D. 7-2224-5-322**  
 5-Light Pendant  
 Warm Brass Finish  
 26"W x 19-1/4"H  
 Adj H 19-1/4" - 73-1/4"  
 5C 60W  
 Clear Crystal

# GENRY



Includes 120' chain & wire

---

10 SAVOYHOUSE.COM | 800 801 1621

# GENRY



**A. 1-8200-5-109**  
5-Light Pendant  
Polished Nickel Finish  
26"W x 25-1/2"H  
5E 60W  
Clear Water Piastra Glass

**B. 1-8200-5-322**  
5-Light Pendant  
Warm Brass Finish  
26"W x 25-1/2"H  
5E 60W  
Clear Water Piastra Glass

**C. 1-8200-5-89**  
5-Light Pendant  
Matte Black Finish  
26"W x 25-1/2"H  
5E 60W  
Clear Water Piastra Glass



# GENRY

---



Includes 120' chain & wire

# GENRY



**A. 1-8203-3-109**  
 3-Light Linear Chandelier  
 Polished Nickel Finish  
 41"L x 13"W x 31-1/2"H  
 3E 60W  
 Clear Water Piastra Glass

**B. 1-8203-3-322**  
 3-Light Linear Chandelier  
 Warm Brass Finish  
 41"L x 13"W x 31-1/2"H  
 3E 60W  
 Clear Water Piastra Glass

**C. 1-8203-3-89**  
 3-Light Linear Chandelier  
 Matte Black Finish  
 41"L x 13"W x 31-1/2"H  
 3E 60W  
 Clear Water Piastra Glass

# GENRY



<b>FAN NUMBER</b>	27-FD-8201-109	27-FD-8201-322	27-FD-8201-89
<b>MOTOR FINISH</b>	Polished Nickel	Warm Brass	Matte Black
<b>BLADE FINISH</b>	Silver	Gold	Black
<b>FAN LIGHT</b>	Integrated	Integrated	Integrated
<b>DOWNROD FINISH</b>	109	322	FB

- Motor Size 104 x 117
- 14" Blade Span
- 27"W x 27-1/2"H
- 13° Blade Pitch
- 3-Speed Reversible Motor
- Additional Downrod Lengths Sold Separately
- 5E 8W LED Dimmable Bulbs (1800 Lumens per bulb, 3000K, 90+ CRI)
- Handheld Remote with E Receiver Included (RMT-AC-UNIVERSAL)
- Not Hugger Kit Adaptable
- Fan & Blades are ETL Damp Location



# GENRY



ENERGY USE AT HIGH SPEED		
Airflow Use <b>1,395</b> Cu Ft/Min	Electricity Use <b>35W</b> Excludes Lights	Airflow Efficiency <b>39.86</b> Cu Ft/Min/W
Compare: 49" to 60" ceiling fans have airflow efficiencies ranging from approximately 51 to 176 cu. ft. per min per watt at high speed.		

**LED**



# VENTARI

---



Includes 12" & 6" extensions - additional stems available - 7-EXT

# VENTARI



Dual Mount Hanging System

**A. 7-8855-1-322**  
 1-Light Pendant  
 Warm Brass Finish  
 10-1/4"W x 11"H  
 Adj H 11' - 65'  
 1E 60W  
 Clear Glass

**B. 7-8857-5-322**  
 5-Light Pendant  
 Warm Brass Finish  
 24"W x 25"H  
 Adj H 25' - 79'  
 5E 60W  
 Clear Glass

**C. 7-8857-5-89**  
 5-Light Pendant  
 Matte Black Finish  
 24"W x 25"H  
 Adj H 25' - 79'  
 5E 60W  
 Clear Glass

**D. 7-8855-1-89**  
 1-Light Pendant  
 Matte Black Finish  
 10-1/4"W x 11"H  
 Adj H 11' - 65'  
 1E 60W  
 Clear Glass

# VENTARI



Includes 12" & 6" extensions - additional stems available - 7-EXT

18 SAVOYHOUSE.COM | 800 801 1621

# VENTARI



Dual Mount Hanging System



B.



A.

- A. 7-8859-8-322**  
8-Light Pendant  
Warm Brass Finish  
25"W x 41"H  
Adj H 41" - 95"  
8E 60W  
Clear Glass
- B. 7-8859-8-89**  
8-Light Pendant  
Matte Black Finish  
25"W x 41"H  
Adj H 41" - 95"  
8E 60W  
Clear Glass

# VENTARI



<b>FAN NUMBER</b>	24-FD-8853-322	24-FD-8853-89
<b>MOTOR FINISH</b>	Warm Brass	Matte Black
<b>BLADE FINISH</b>	Gold	Black
<b>FAN LIGHT</b>	Integrated	Integrated
<b>DOWNROD FINISH</b>	322	FB

- Motor Size 80 x 70
- 12' Blade Span
- 24"W x 30"H
- 16" Blade Pitch
- 3-Speed Reversible Motor
- Additional Downrod Lengths Sold Separately
- 5C 6W LED Dimmable Bulbs (500 Lumens per bulb, 3000K, 90+ CRI)
- Handheld Remote with C Receiver Included (RMT-AC-UNIVERSAL)
- Not Hugger Kit Adaptable
- Fan & Blades are ETL Dry Location



# VENTARI



ENERGY USE AT HIGH SPEED		
Airflow Use <b>1,222</b> Cu Ft/Min	Electricity Use <b>28.1W</b> Excludes Lights	Airflow Efficiency <b>43.48</b> Cu Ft/Min/W
Compare: 49" to 60" ceiling fans have airflow efficiencies ranging from approximately 51 to 176 cu. ft. per min per watt at high speed.		

**LED**



# WINFIELD

---



\*Includes 9-1/2" extensions - additional stems available - 7-EXT

\*\*Includes 12" & 6" extensions - additional stems available - 7-EXT



# WINFIELD

**A. 9-9771-2-89**

2-Light Sconce  
Matte Black Finish  
4-1/2"W x 15-1/2"H x 5-1/2"E  
2C 60W  
Clear Glass

**B. 7-9770-1-89**

1-Light Mini-Pendant  
Matte Black Finish  
5-1/8"W x 15-3/4"H  
Adj H 15-3/4" - 47-1/4"  
1E 60W  
90° Swivel  
Clear Glass

**C. 1-9772-10-89**

10-Light Chandelier  
Matte Black Finish  
25"W x 18-1/2"H  
Adj H 18-1/2" - 75-1/2"  
10C 60W  
30° Swivel  
Clear Glass

**D. 1-9773-12-89**

12-Light Linear Chandelier  
Matte Black Finish  
38"L x 14"W x 17-1/4"H  
Adj H 17-1/4" - 74-1/4"  
12C 60W  
30° Swivel  
Clear Glass

# WINFIELD

**A. 9-9771-2-322**

2-Light Sconce  
Warm Brass Finish  
4-1/2"W x 15-1/2"H x 5-1/2"E  
2C 60W  
Clear Glass

**B. 7-9770-1-322**

1-Light Mini-Pendant  
Warm Brass Finish  
5-1/8"W x 15-3/4"H  
Adj H 15-3/4" - 47-1/4"  
1E 60W  
90° Swivel  
Clear Glass

**C. 1-9772-10-322**

10-Light Chandelier  
Warm Brass Finish  
25"W x 18-1/2"H  
Adj H 18-1/2" - 75-1/2"  
10C 60W  
30° Swivel  
Clear Glass

**D. 1-9773-12-322**

12-Light Linear Chandelier  
Warm Brass Finish  
38"L x 14"W x 17-1/4"H  
Adj H 17-1/4" - 74-1/4"  
12C 60W  
30° Swivel  
Clear Glass

# WINFIELD



\*Includes 9-1/2' extensions - additional stems available - 7-EXT  
\*\*Includes 12' & 6' extensions - additional stems available - 7-EXT

# FALSTER

---



LED

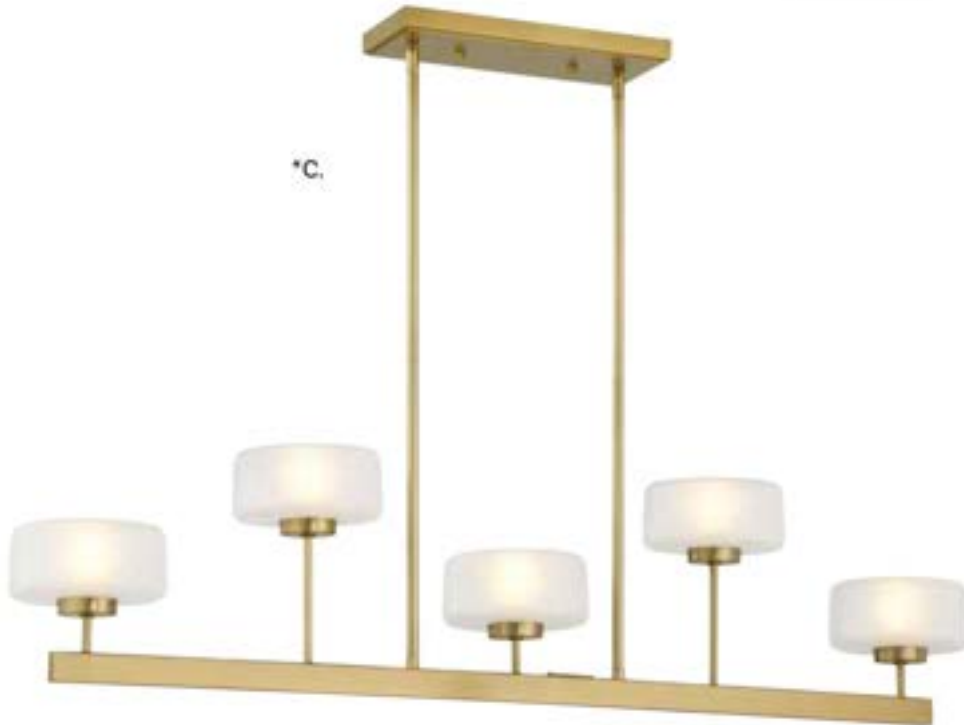

\*Includes 12" & 6" extensions - additional stems available - 7-EXT

# FALSTER



Dual Mount Hanging System

**A. 1-5409-5-322**  
 5-Light Chandelier  
 Warm Brass Finish  
 26"W x 5-1/2"H  
 Adj H 5-1/2" - 59-1/2"  
 5G9 3W LED  
 810 Lumens, 3000K, 90+ CRI  
 Frosted Seeded Glass  
**G9 Bulbs Included**

**B. 9-5405-1-322**  
 1-Light Sconce  
 Warm Brass Finish  
 5-3/4"W x 7"H x 8-1/2"E  
 1G9 3W LED  
 160 Lumens, 3000K, 90+ CRI  
 Frosted Seeded Glass  
**G9 Bulb Included**

**C. 1-5407-5-322**  
 5-Light Linear Chandelier  
 Warm Brass Finish  
 42"L x 5-3/4"W x 9-1/2"H  
 Adj H 9-1/2" - 63-1/2"  
 5G9 3W LED  
 810 Lumens, 3000K, 90+ CRI  
 Frosted Seeded Glass  
**G9 Bulbs Included**

# FALSTER



Dual Mount Hanging System

## A. 9-5405-1-89

1-Light Sconce  
Matte Black Finish  
5-3/4"W x 7"H x 8-1/2"E  
1G9 3W LED  
160 Lumens, 3000K, 90+ CRI  
Frosted Seeded Glass  
**G9 Bulb Included**

## B. 1-5409-5-89

5-Light Chandelier  
Matte Black Finish  
26"W x 5-1/2"H  
Adj H 5-1/2" - 59-1/2"  
5G9 3W LED  
810 Lumens, 3000K, 90+ CRI  
Frosted Seeded Glass  
**G9 Bulbs Included**

## C. 1-5407-5-89

5-Light Linear Chandelier  
Matte Black Finish  
42"L x 5-3/4"W x 9-1/2"H  
Adj H 9-1/2" - 63-1/2"  
5G9 3W LED  
810 Lumens, 3000K, 90+ CRI  
Frosted Seeded Glass  
**G9 Bulbs Included**

# FALSTER



\*Includes 12" & 6" extensions - additional stems available - 7-EXT

# FALLON



\*Includes 12" & 6" extensions - additional stems available - 7-EXT



# FALLON



Dual Mount Hanging System

**A. 1-1613-4-89**  
 4-Light Chandelier  
 Matte Black Finish  
 30"W x 11"H  
 Adj H 11" - 65"  
 4G9 60W  
 White Opal Glass  
**G9 Bulbs Included**

**B. 9-1615-1-89**  
 1-Light Sconce  
 Matte Black Finish  
 10"W x 15"H x 5-1/2"E  
 1G9 60W  
 White Opal Glass  
**G9 Bulb Included**

**C. 1-1613-4-322**  
 4-Light Chandelier  
 Warm Brass Finish  
 30"W x 11"H  
 Adj H 11" - 65"  
 4G9 60W  
 White Opal Glass  
**G9 Bulbs Included**

**D. 9-1615-1-322**  
 1-Light Sconce  
 Warm Brass Finish  
 10"W x 15"H x 5-1/2"E  
 1G9 60W  
 White Opal Glass  
**G9 Bulbs Included**

# FALLON



Includes 12' & 6" extensions - additional stems available - 7-EXT

32 SAVOYHOUSE.COM | 800-801-1621

# FALLON



**A. 1-1614-3-322**  
3-Light Linear Chandelier  
Warm Brass Finish  
45"L x 10"W x 4-1/2"H  
Adj H 4-1/2" - 58-1/2"  
3G9 60W  
White Opal Glass  
**G9 Bulbs Included**

**B. 1-1614-3-89**  
3-Light Linear Chandelier  
Matte Black Finish  
45"L x 10"W x 4-1/2"H  
Adj H 4-1/2" - 58-1/2"  
3G9 60W  
White Opal Glass  
**G9 Bulbs Included**

# HAYNES

---



\*Includes 12" & 6" extensions - additional stems available - 7-EXT

# HAYNES



Dual Mount Hanging System

**A. 1-2803-5-89**  
 5-Light Linear Chandelier  
 Matte Black Finish  
 48"L x 4"W x 16"H  
 Adj H 16" - 70"  
 5C 60W  
 White Opal Glass

**B. 1-2802-6-89**  
 6-Light Chandelier  
 Matte Black Finish  
 30"W x 16"H  
 Adj H 16" - 70"  
 6C 60W  
 White Opal Glass

**C. 9-2801-1-89**  
 1-Light Sconce  
 Matte Black Finish  
 5"W x 16"H x 7"E  
 1C 60W  
 White Opal Glass

# HAYNES



Dual Mount Hanging System

**A. 1-2803-5-322**

5-Light Linear Chandelier  
 Warm Brass Finish  
 48"L x 4"W x 16"H  
 Adj H 16" - 70"  
 5C 60W  
 White Opal Glass

**B. 1-2802-6-322**

6-Light Chandelier  
 Warm Brass Finish  
 30"W x 16"H  
 Adj H 16" - 70"  
 6C 60W  
 White Opal Glass

**C. 9-2801-1-322**

1-Light Sconce  
 Warm Brass Finish  
 5"W x 16"H x 7"E  
 1C 60W  
 White Opal Glass

# HAYNES



\*Includes 12" & 6" extensions - additional stems available - 7-EXT

# CRISTOFER



Includes 12' & 6" extensions - additional stems available - 7-EXT

38 SAVOYHOUSE.COM | 800 801 1621



# CRISTOFER



Dual Mount Hanging System



A.

- A. 1-1624-8-89**  
8-Light Linear Chandelier  
Matte Black Finish  
36"L x 21"W x 8"H  
Adj H 8" - 62"  
8C 60W

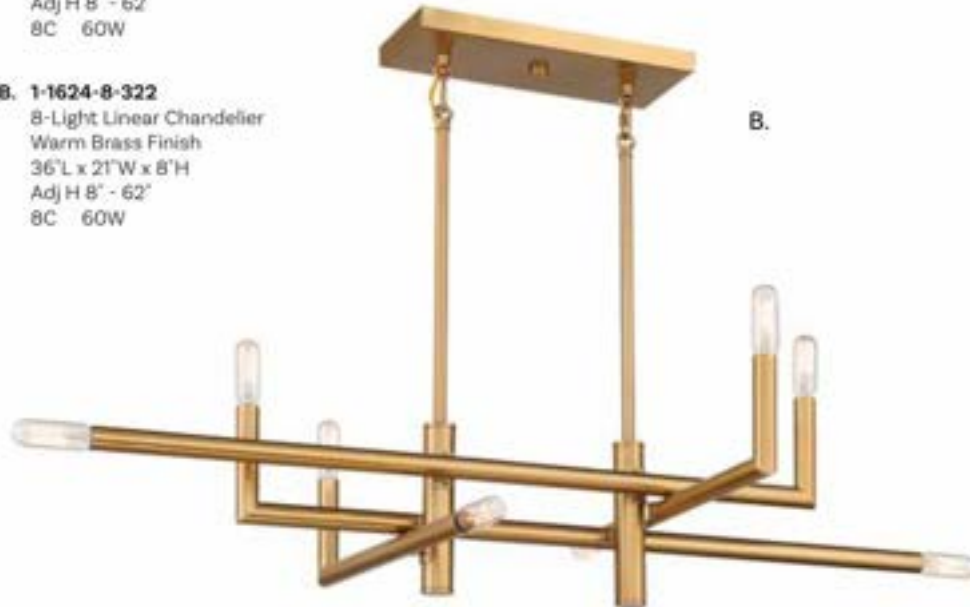

B.

- B. 1-1624-8-322**  
8-Light Linear Chandelier  
Warm Brass Finish  
36"L x 21"W x 8"H  
Adj H 8" - 62"  
8C 60W

# CRISTOFER



Includes 12" & 6" extensions - additional stems available - 7-EXT

40 SAVOYHOUSE.COM | 800 801 1621

# CRISTOFER



Dual Mount Hanging System

A.



**A. 1-1623-6-322**  
6-Light Chandelier  
Warm Brass Finish  
30"W x 17"H  
Adj H 17" - 71"  
6C 60W

B.

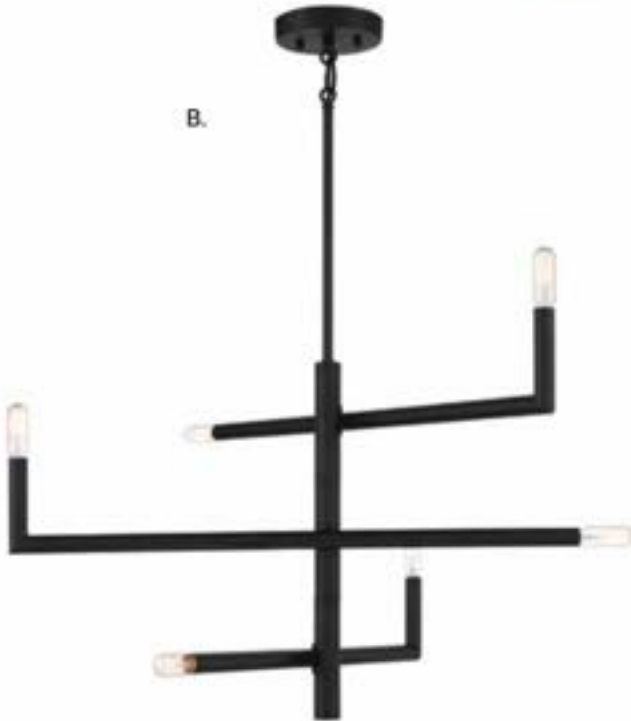

**B. 1-1623-6-89**  
6-Light Chandelier  
Matte Black Finish  
30"W x 17"H  
Adj H 17" - 71"  
6C 60W

# WRIGHT



\*Includes 12" & 6" extensions - additional stems available - **7-EXTLG**

\*\*Includes 12" & 6" extensions - additional stems available - **7-EXT**

# WRIGHT

\*A.



\*\*B.



**A. 1-3074-8-89**  
 8-Light Chandelier  
 Matte Black Finish  
 40"W x 10"H  
 Adj H 10" - 64"  
 8E 60W  
 Clear Glass

**B. 1-3073-5-89**  
 5-Light Chandelier  
 Matte Black Finish  
 28"W x 10"H  
 Adj H 10" - 64"  
 5E 60W  
 Clear Glass



Dual Mount Hanging System



Pendant, Page 179



Bath, Page 263



Sconce, Page 262

# WRIGHT

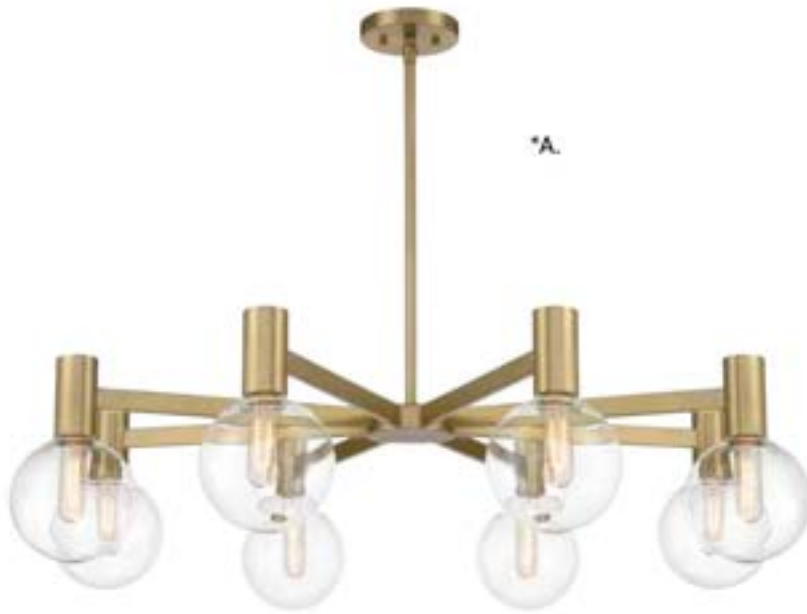

Dual Mount Hanging System



**A. 1-3074-8-322**  
 8-Light Chandelier  
 Warm Brass Finish  
 40"W x 10"H  
 Adj H 10" - 64"  
 8E 60W  
 Clear Glass

**B. 1-3073-5-322**  
 5-Light Chandelier  
 Warm Brass Finish  
 28"W x 10"H  
 Adj H 10" - 64"  
 5E 60W  
 Clear Glass

\*Includes 12" & 6" extensions - additional stems available - 7-EXTLG

\*\*Includes 12" & 6" extensions - additional stems available - 7-EXT



Sconce, Page 261



Bath, Page 262



Pendant, Page 178

# WRIGHT



Dual Mount Hanging System



\*C.



\*\*D.

**C. 1-3074-8-11**  
 8-Light Chandelier  
 Polished Chrome Finish  
 40"W x 10"H  
 Adj H 10" - 64"  
 BE 60W  
 Clear Glass

**D. 1-3073-5-11**  
 5-Light Chandelier  
 Polished Chrome Finish  
 28"W x 10"H  
 Adj H 10" - 64"  
 SE 60W  
 Clear Glass



Pendant, Page 178



Bath, Page 262



Sconce, Page 261

# CROSBY



**A. 1-1862-8-322**  
 8-Light Linear Chandelier  
 Warm Brass Finish  
 42"L x 16"W x 9-3/4"H  
 Adj H 9-3/4" - 63-3/4"  
 8C 60W  
 Clear Glass

**B. 1-1862-8-89**  
 8-Light Linear Chandelier  
 Matte Black Finish  
 42"L x 16"W x 9-3/4"H  
 Adj H 9-3/4" - 63-3/4"  
 8C 60W  
 Clear Glass



# CROSBY



Includes 12' & 6" extensions - additional stems available - 7-EXT

# CROSBY



Includes 12" & 6" extensions - additional stems available - 7-EXT

# CROSBY



Dual Mount Hanging System



A.



B.

**A. 1-1861-8-89**  
8-Light Chandelier  
Matte Black Finish  
30"L x 30"W x 9-3/4"H  
Adj H 9-3/4" - 63-3/4"  
8C 60W  
Clear Glass

**B. 1-1861-8-322**  
8-Light Chandelier  
Warm Brass Finish  
30"L x 30"W x 9-3/4"H  
Adj H 9-3/4" - 63-3/4"  
8C 60W  
Clear Glass



Bath, Page 264

# LAKEWOOD



Dual Mount Hanging System

**A. 7-1831-1-322**  
 1-Light Mini-Pendant  
 Warm Brass Finish  
 8"W x 22"H  
 Adj H 22" - 50-1/2"  
 1E 60W  
 Clear Glass

**B. 1-1832-5-322**  
 5-Light Chandelier  
 Warm Brass Finish  
 28"W x 20"H  
 Adj H 20" - 74"  
 5E 60W  
 Clear Glass

**C. 1-1833-6-322**  
 6-Light Linear Chandelier  
 Warm Brass Finish  
 40"L x 17-1/2"W x 17"H  
 Adj H 17" - 71"  
 6E 60W  
 Clear Glass

# LAKEWOOD



Pendants, Page 174

\*Includes 9-1/2' extensions - additional stems available - 7-EXT

\*\*Includes 12' & 6' extensions - additional stems available - 7-EXT

# LAKEWOOD



Dual Mount Hanging System

**A. 7-1831-1-89**  
 1-Light Mini-Pendant  
 Matte Black Finish  
 8"W x 22"H  
 Adj H 22" - 50-1/2"  
 1E 60W  
 Clear Glass

**B. 1-1832-5-89**  
 5-Light Chandelier  
 Matte Black Finish  
 28"W x 20"H  
 Adj H 20" - 74"  
 5E 60W  
 Clear Glass

**C. 1-1833-6-89**  
 6-Light Linear Chandelier  
 Matte Black Finish  
 40"L x 17-1/2"W x 17"H  
 Adj H 17" - 71"  
 6E 60W  
 Clear Glass

# LAKEWOOD



\*A.



\*\*B.



\*\*C.



Pendants, Page 174

\*Includes 9-1/2' extensions - additional stems available - 7-EXT

\*\*Includes 12' & 6' extensions - additional stems available - 7-EXT

# MIDDLETON



Includes 120' chain & wire

---

54 SAVOYHOUSE.COM | 800 801 1621



# MIDDLETON

---



A.



B.

**A. 1-307-6-89**  
6-Light Chandelier  
Matte Black Finish  
25"W x 23"H  
6C 60W  
Metal Candle Covers

**B. 1-307-6-322**  
6-Light Chandelier  
Warm Brass Finish  
25"W x 23"H  
6C 60W  
Metal Candle Covers

# MIDDLETON



**A. 1-308-8-89**  
8-Light Chandelier  
Matte Black Finish  
33"W x 25"H  
8C 60W  
Metal Candle Covers

**B. 1-308-8-322**  
8-Light Chandelier  
Warm Brass Finish  
33"W x 25"H  
8C 60W  
Metal Candle Covers

**C. 1-308-8-5N**  
8-Light Chandelier  
Satin Nickel Finish  
33"W x 25"H  
8C 60W  
Metal Candle Covers

**D. 1-308-8-44**  
8-Light Chandelier  
Classic Bronze Finish  
33"W x 25"H  
8C 60W  
Metal Candle Covers

# MIDDLETON



Includes 120" chain & wire

# MIDDLETON



Includes 120' chain & wire

58 SAVOYHOUSE.COM | 800 801 1621

# MIDDLETON

---

**A. 1-310-10-322**  
10-Light Chandelier  
Warm Brass Finish  
45"W x 32-1/4"H  
10C 60W  
Metal Candle Covers

**B. 1-310-10-89**  
10-Light Chandelier  
Matte Black Finish  
45"W x 32-1/4"H  
10C 60W  
Metal Candle Covers



# MIDDLETON



Includes 120' chain & wire

60 SAVOYHOUSE.COM | 800 801 1621

# MIDDLETON

---



# SEVILLE



Includes 120' chain & wire

62 SAVOYHOUSE.COM | 800 801 1621



# SEVILLE



**A. 1-4404-B-89**  
8-Light Chandelier  
Matte Black Finish  
34"W x 29-1/2"H  
8C 60W  
Metal Candle Covers

**B. 1-4404-B-322**  
8-Light Chandelier  
Warm Brass Finish  
34"W x 29-1/2"H  
8C 60W  
Metal Candle Covers

# SEVILLE

---



**A. 1-4405-10-322**  
10-Light Chandelier  
Warm Brass Finish  
45"W x 33"H  
10C 60W  
Metal Candle Covers

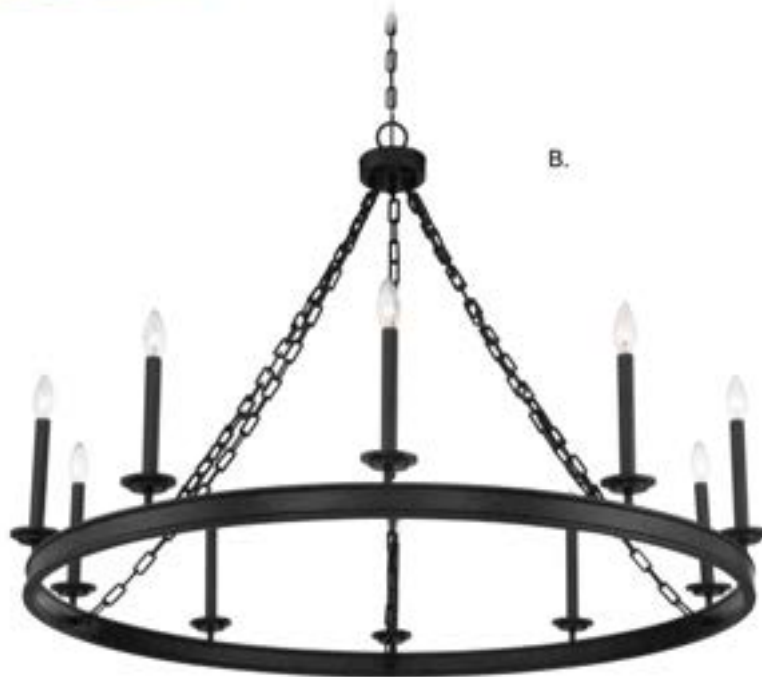

**B. 1-4405-10-89**  
10-Light Chandelier  
Matte Black Finish  
45"W x 33"H  
10C 60W  
Metal Candle Covers

# SEVILLE



Includes 120" chain & wire

# SEVILLE

---



**A. 1-4406-15-89**  
15-Light Chandelier  
Matte Black Finish  
45"W x 43"H  
15C 60W  
Metal Candle Covers

Includes 120' chain & wire

# SEVILLE



**B. 1-4406-15-322**  
15-Light Chandelier  
Warm Brass Finish  
45"W x 43"H  
15C 60W  
Metal Candle Covers

# LYRIQUE

---

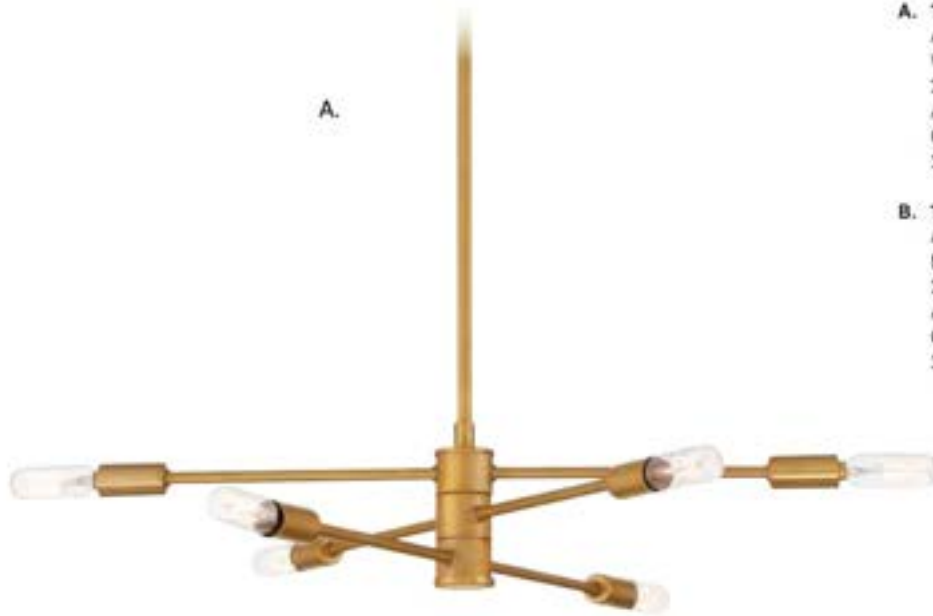

**A. 1-7000-6-322**  
Adjustable 6-Light Chandelier  
Warm Brass Finish  
21-3/4"W x 7"H  
Adj H 7" - 61"  
6C 60W  
30° Swivel



**B. 1-7000-6-89**  
Adjustable 6-Light Chandelier  
Matte Black Finish  
21-3/4"W x 7"H  
Adj H 7" - 61"  
6C 60W  
30° Swivel

Includes 12" & 6" extensions - additional stems available - **7-EXT**  
The arms of the Chandeliers are adjustable and can rotate into different positions

# LYRIQUE

**C. 1-7000-6-77**

Adjustable 6-Light Chandelier  
Bronze w/ Brass Accents  
21-3/4"W x 7"H  
Adj H 7" - 61"  
6C 60W  
30° Swivel



C.

**D. 1-7000-6-109**

Adjustable 6-Light Chandelier  
Polished Nickel Finish  
21-3/4"W x 7"H  
Adj H 7" - 61"  
6C 60W  
30° Swivel

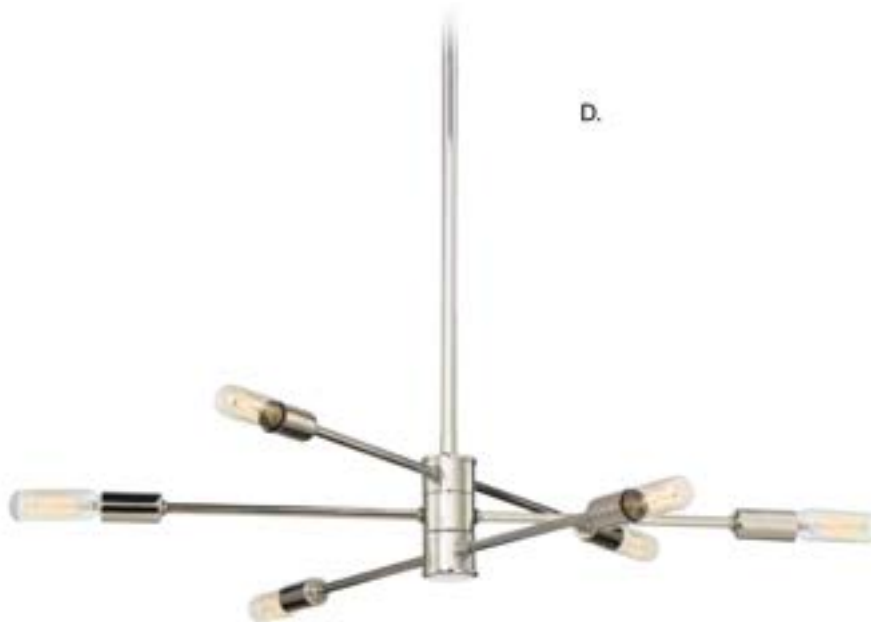

D.

# LYRIQUE

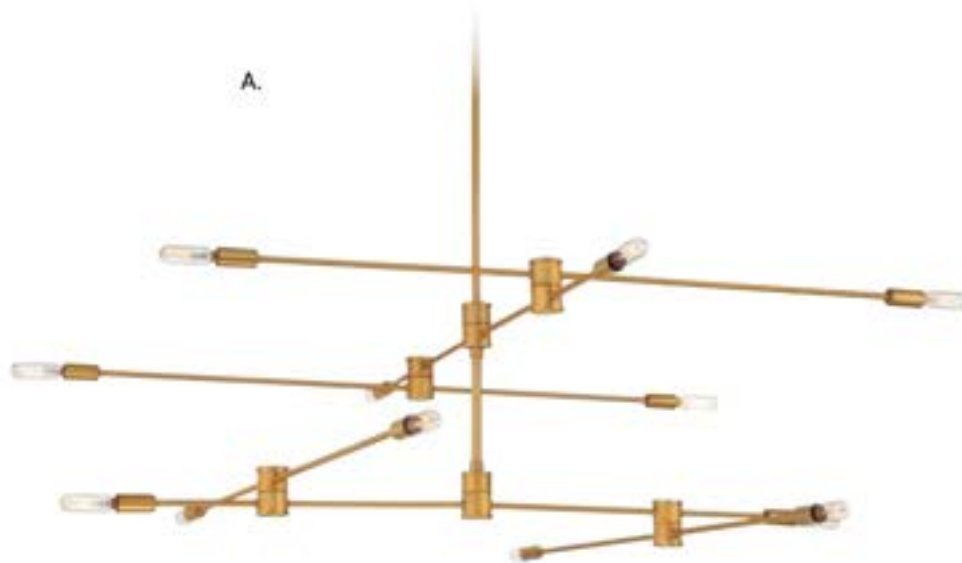

**A. 1-7001-12-322**  
Adjustable  
12-Light Chandelier  
Warm Brass Finish  
54-1/4"W x 15"H  
Adj H 15" - 69"  
12C 60W  
30° Swivel

**B. 1-7001-12-89**  
Adjustable  
12-Light Chandelier  
Matte Black Finish  
54-1/4"W x 15"H  
Adj H 15" - 69"  
12C 60W  
30° Swivel

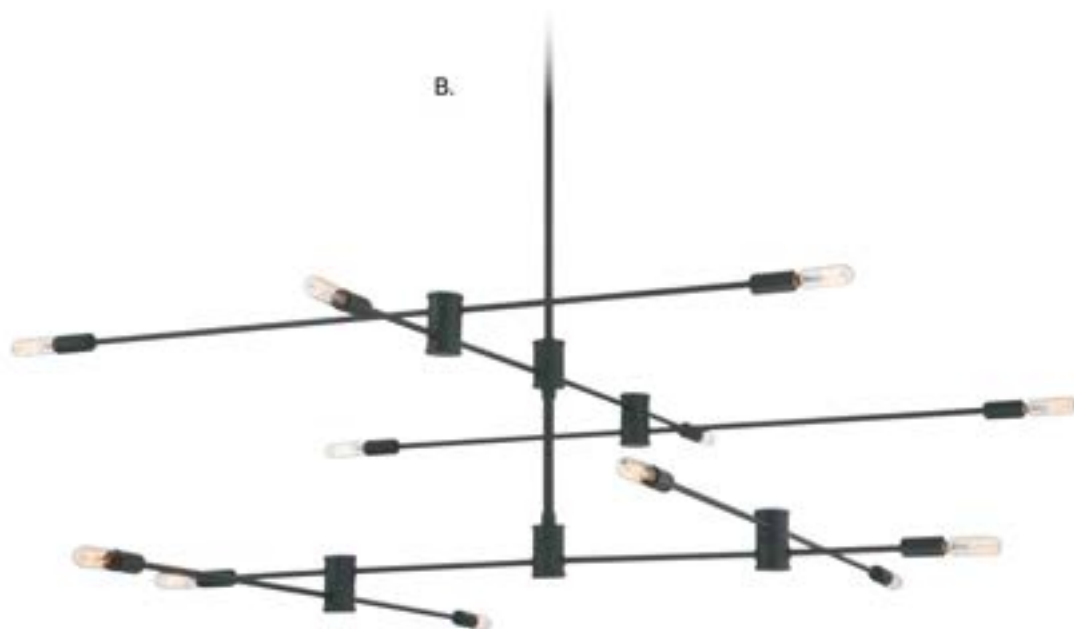

Includes 12" & 6" extensions - additional stems available - **7-EXT**  
The arms of the Chandeliers are adjustable and can rotate into different positions



# LYRIQUE

**C. 1-7001-12-109**

Adjustable  
12-Light Chandelier  
Polished Nickel Finish  
54-1/4"W x 15"H  
Adj H 15" - 69"  
12C 60W  
30° Swivel

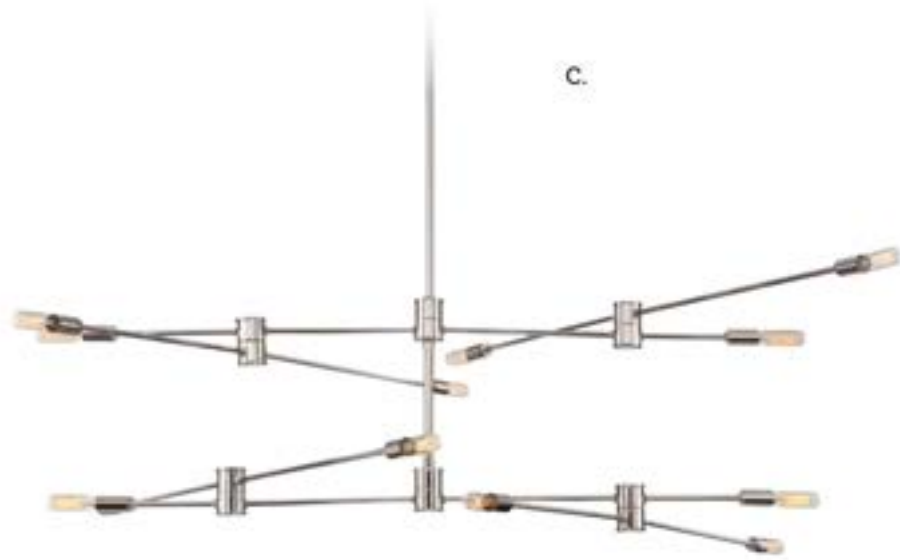

**D. 1-7001-12-77**

Adjustable  
12-Light Chandelier  
Bronze w/ Brass Accents  
54-1/4"W x 15"H  
Adj H 15" - 69"  
12C 60W  
30° Swivel

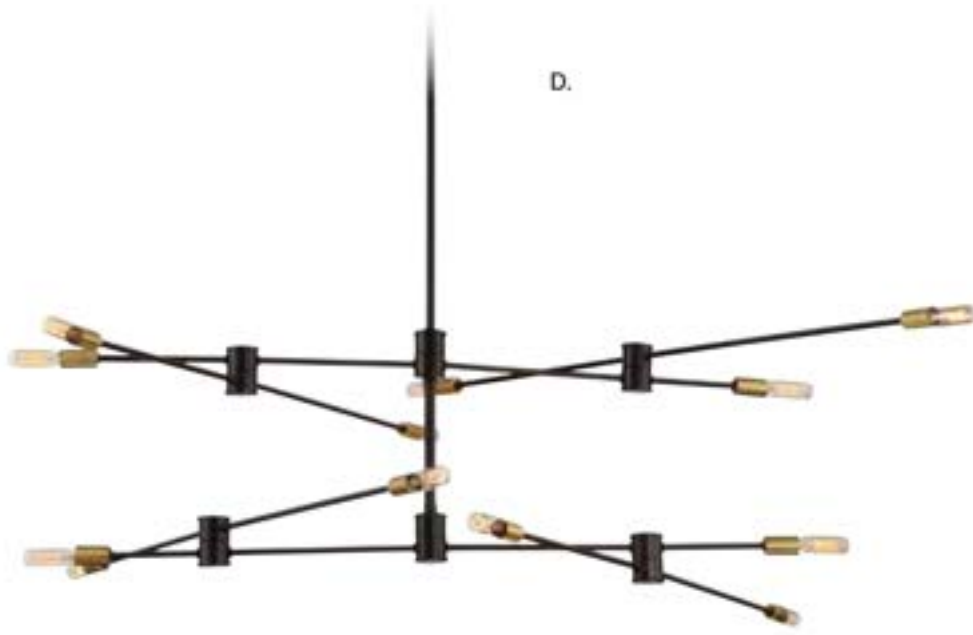

# SALERNO



**A. 1-2221-6-109**

6-Light Chandelier  
Polished Nickel Finish  
42"W x 25"H  
6C 60W  
Metal Candle Covers

**B. 1-2221-6-89**

6-Light Chandelier  
Matte Black Finish  
42"W x 25"H  
6C 60W  
Metal Candle Covers

**C. 1-2221-6-83**

6-Light Chandelier  
Bisque White Finish  
42"W x 25"H  
6C 60W  
Metal Candle Covers

**D. 1-2221-6-322**

6-Light Chandelier  
Warm Brass Finish  
42"W x 25"H  
6C 60W  
Metal Candle Covers

# SALERNO

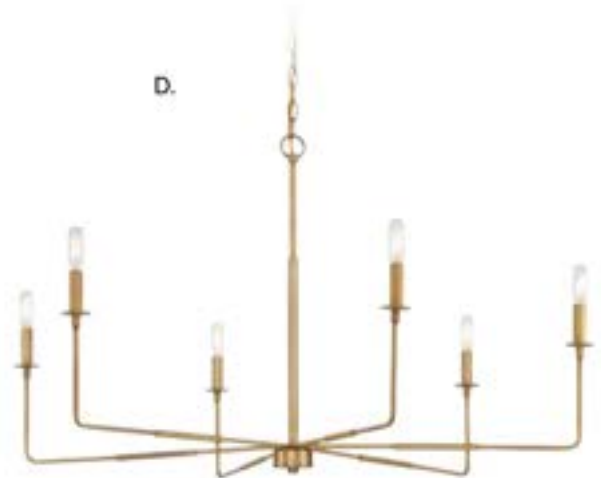
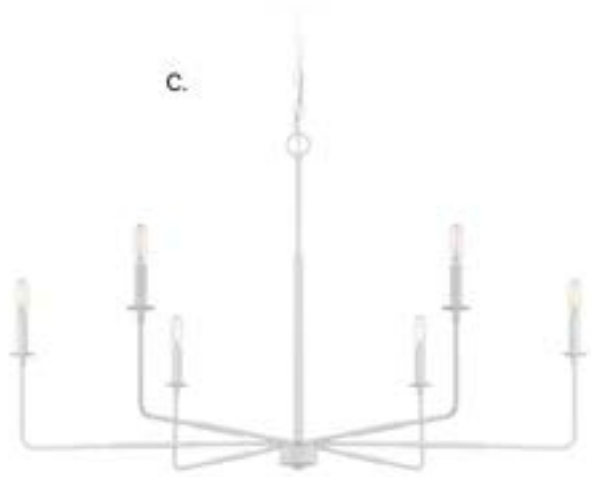
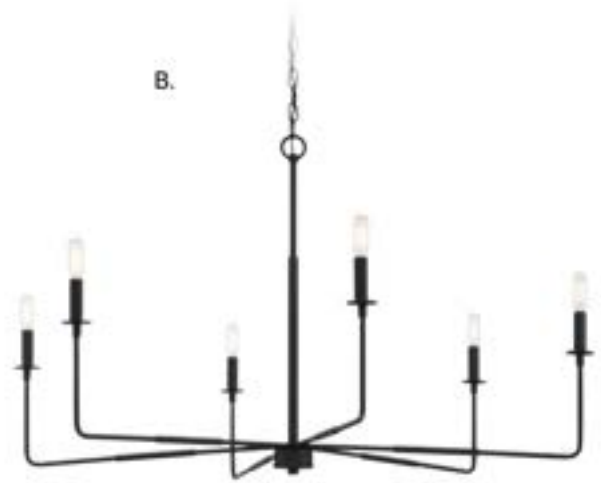
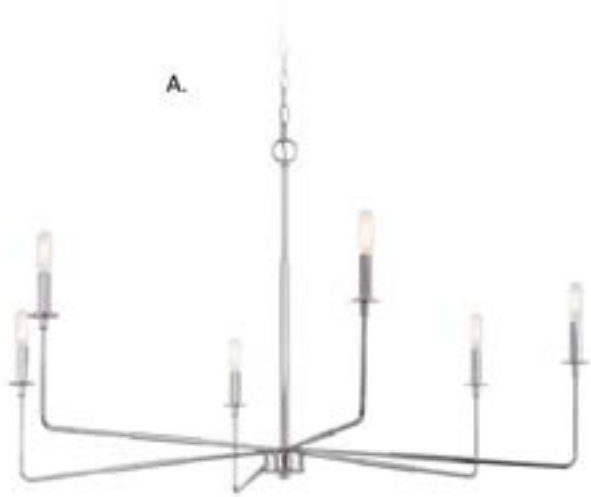

Includes 120" chain & wire

# JASMINE

---



Includes 12' & 6" extensions - additional stems available - 7-EXT

# JASMINE



Dual Mount Hanging System

**A. 1-4410-5-109**  
 5-Light Chandelier  
 Polished Nickel Finish  
 30"W x 15-1/2"H  
 Adj H 15-1/2' - 69-1/2'  
 5C 60W  
 White Candle Covers

**B. 1-4410-5-322**  
 5-Light Chandelier  
 Warm Brass Finish  
 30"W x 15-1/2"H  
 Adj H 15-1/2' - 69-1/2'  
 5C 60W  
 White Candle Covers

**C. 1-4410-5-89**  
 5-Light Chandelier  
 Matte Black Finish  
 30"W x 15-1/2"H  
 Adj H 15-1/2' - 69-1/2'  
 5C 60W  
 White Candle Covers

# JASMINE

---



Includes 12" & 6" extensions - additional stems available - 7-EXT

# JASMINE



Dual Mount Hanging System

**A. 1-4412-8-322**  
 8-Light Chandelier  
 Warm Brass Finish  
 42"W x 15-1/2"H  
 Adj H 15-1/2" - 69-1/2"  
 8C 60W  
 White Candle Covers

**B. 1-4412-8-109**  
 8-Light Chandelier  
 Polished Nickel Finish  
 42"W x 15-1/2"H  
 Adj H 15-1/2" - 69-1/2"  
 8C 60W  
 White Candle Covers

**C. 1-4412-8-89**  
 8-Light Chandelier  
 Matte Black Finish  
 42"W x 15-1/2"H  
 Adj H 15-1/2" - 69-1/2"  
 8C 60W  
 White Candle Covers

# TORINO

---



\*Includes 12" & 6" extensions - additional stems available - 7-EXT

\*\*Includes 12" & 6" extensions - additional stems available - 7-EXTLG



# TORINO



Dual Mount Hanging System

**A. 1-2451-8-89**

8-Light Chandelier  
Matte Black Finish  
34"W x 9"H  
Adj H 9' - 63"  
8C 60W  
Metal Candle Covers

**B. 1-2450-6-89**

6-Light Chandelier  
Matte Black Finish  
28"W x 9"H  
Adj H 9' - 63"  
6C 60W  
Metal Candle Covers

**C. 1-2450-6-322**

6-Light Chandelier  
Warm Brass Finish  
28"W x 9"H  
Adj H 9' - 63"  
6C 60W  
Metal Candle Covers

**D. 1-2451-8-322**

8-Light Chandelier  
Warm Brass Finish  
34"W x 9"H  
Adj H 9' - 63"  
8C 60W  
Metal Candle Covers

# NEWPORT



Dual Mount Hanging System

**A. 7-2521-4-322**  
 4-Light Pendant  
 Warm Brass Finish  
 18"W x 26"H  
 Adj H 26" - 80"  
 4C 60W  
 Soft White  
 Fabric Shade

**B. 1-2520-6-322**  
 6-Light Oval Chandelier  
 Warm Brass Finish  
 42"L x 16"W x 23"H  
 Adj H 23" - 77"  
 6C 60W  
 Soft White  
 Fabric Shade

**C. 1-2520-6-89**  
 6-Light Oval Chandelier  
 Matte Black Finish  
 42"L x 16"W x 23"H  
 Adj H 23" - 77"  
 6C 60W  
 Soft White  
 Fabric Shade

**D. 7-2521-4-89**  
 4-Light Pendant  
 Matte Black Finish  
 18"W x 26"H  
 Adj H 26" - 80"  
 4C 60W  
 Soft White  
 Fabric Shade

# NEWPORT



Includes 12" & 6" extensions - additional stems available - 7-EXT

# BRODY



\*Includes 12' & 6" extensions - additional stems available - 7-EXT

82 SAVOYHOUSE.COM | 800 801 1621

# BRODY



**A. 9-1632-1-173**  
 1-Light Sconce  
 Matte Black w/  
 Polished Nickel Accents  
 5-3/4"W x 16"H x 8"E  
 1C 60W  
 White Fabric Shade

**B. 1-1630-5-173**  
 5-Light Chandelier  
 Matte Black w/  
 Polished Nickel Accents  
 28"W x 18"H  
 Adj H 18" - 72"  
 5C 60W  
 White Fabric Shade

**C. 1-1630-5-143**  
 5-Light Chandelier  
 Matte Black w/  
 Warm Brass Accents  
 28"W x 18"H  
 Adj H 18" - 72"  
 5C 60W  
 White Fabric Shade

**D. 9-1632-1-143**  
 1-Light Sconce  
 Matte Black w/  
 Warm Brass Accents  
 5-3/4"W x 16"H x 8"E  
 1C 60W  
 White Fabric Shade

# BRODY



Dual Mount Hanging System

**A. 1-1631-6-143**  
6-Light Linear Chandelier  
Matte Black w/  
Warm Brass Accents  
41"L x 18"W x 18"H  
Adj H 18" - 72"  
6C 60W  
White Fabric Shade

**B. 1-1631-6-173**  
6-Light Linear Chandelier  
Matte Black w/  
Polished Nickel Accents  
41"L x 18"W x 18"H  
Adj H 18" - 72"  
6C 60W  
White Fabric Shade



# BRODY



Includes 12" & 6" extensions - additional stems available - **7-EXT**

# EDGEWOOD



Includes 12' & 6" extensions - additional stems available - 7-EXT

86 SAVOYHOUSE.COM | 800 801 1621



# EDGEWOOD

**A. 1-1785-6-322**

6-Light Linear Chandelier  
 Warm Brass Finish  
 35"L X 16-1/8"W x 10"H  
 Adj H 10" - 64"  
 6C 60W  
 Black Fabric Shade

**B. 1-1786-5-322**

5-Light Linear Chandelier  
 Warm Brass Finish  
 32"W x 10"H  
 Adj H 10" - 64"  
 5C 60W  
 Black Fabric Shade

**C. 1-1786-5-89**

5-Light Linear Chandelier  
 Matte Black Finish  
 32"W x 10"H  
 Adj H 10" - 64"  
 5C 60W  
 Oatmeal Fabric Shade

**D. 1-1785-6-89**

6-Light Linear Chandelier  
 Matte Black Finish  
 35"L X 16-1/8"W x 10"H  
 Adj H 10" - 64"  
 6C 60W  
 Oatmeal Fabric Shade

# POWELL

---



Includes 120' chain & wire

# POWELL



**A. 1-1756-6-89**  
6-Light Linear Chandelier  
Matte Black Finish  
35"L x 15"W x 23"H  
6C 60W  
White Fabric Shade

**B. 1-1756-6-322**  
6-Light Linear Chandelier  
Warm Brass Finish  
35"L x 15"W x 23"H  
6C 60W  
White Fabric Shade

**C. 1-1756-6-109**  
6-Light Linear Chandelier  
Polished Nickel Finish  
35"L x 15"W x 23"H  
6C 60W  
White Fabric Shade



Source, Page 227

# CAMERON

---



Bath, Page 285



Sconce, Page 222

---

Includes 12' & 6" extensions - additional stems available - 7-EXT

## CAMERON



**A. 1-2540-5-89**  
 5-Light Chandelier  
 Matte Black Finish  
 29"W x 13"H  
 Adj H 13" - 67"  
 5C 40W  
 30° Swivel  
 White Fabric Shade  
 Metal Candle Covers

**B. 1-2540-5-109**  
 5-Light Chandelier  
 Polished Nickel Finish  
 29"W x 13"H  
 Adj H 13" - 67"  
 5C 40W  
 30° Swivel  
 White Fabric Shade  
 Metal Candle Covers

**C. 1-2540-5-322**  
 5-Light Chandelier  
 Warm Brass Finish  
 29"W x 13"H  
 Adj H 13" - 67"  
 5C 40W  
 30° Swivel  
 White Fabric Shade  
 Metal Candle Covers

# CAMERON



Includes 12" & 6" extensions - additional stems available - 7-EXT

92 SAVOYHOUSE.COM | 800 801 1621

# CAMERON



**A. 1-2541-9-89**  
 9-Light Chandelier  
 Matte Black Finish  
 35"W x 24"H  
 Adj H 24" - 78"  
 9C 40W  
 30° Swivel  
 White Fabric Shade  
 Metal Candle Covers

**B. 1-2541-9-322**  
 9-Light Chandelier  
 Warm Brass Finish  
 35"W x 24"H  
 Adj H 24" - 78"  
 9C 40W  
 30° Swivel  
 White Fabric Shade  
 Metal Candle Covers

**C. 1-2541-9-109**  
 9-Light Chandelier  
 Polished Nickel Finish  
 35"W x 24"H  
 Adj H 24" - 78"  
 9C 40W  
 30° Swivel  
 White Fabric Shade  
 Metal Candle Covers



# CARLTON



**A. 1-3392-4-89**  
 4-Light Chandelier  
 Matte Black Finish  
 24"W x 25"H  
 4C 60W  
 Clear Ribbed Glass

**B. 1-3394-8-89**  
 8-Light Chandelier  
 Matte Black Finish  
 36"W x 32-1/2"H  
 8C 60W  
 Clear Ribbed Glass

**C. 1-3394-8-322**  
 8-Light Chandelier  
 Warm Brass Finish  
 36"W x 32-1/2"H  
 8C 60W  
 Clear Ribbed Glass

**D. 1-3392-4-322**  
 4-Light Chandelier  
 Warm Brass Finish  
 24"W x 25"H  
 4C 60W  
 Ribbed Glass



Pendant, Page T78



# CARLTON



Includes 120" chain & wire

# CRAWFORD



Includes 120' chain & wire

96 SAVOYHOUSE.COM | 800 801 1621

# CRAWFORD



**A. 7-1803-3-322**  
 3-Light Pendant  
 Warm Brass Finish  
 12"W x 25-1/2"H  
 3C 60W  
 Clear Water Glass

**B. 7-1803-3-SN**  
 3-Light Pendant  
 Satin Nickel Finish  
 12"W x 25-1/2"H  
 3C 60W  
 Clear Water Glass

**C. 7-1803-3-B9**  
 3-Light Pendant  
 Matte Black Finish  
 12"W x 25-1/2"H  
 3C 60W  
 Clear Water Glass



**D. 7-1804-4-322**  
 4-Light Pendant  
 Warm Brass Finish  
 18"W x 39-1/2"H  
 4C 60W  
 Clear Water Glass

**E. 7-1804-4-SN**  
 4-Light Pendant  
 Satin Nickel Finish  
 18"W x 39-1/2"H  
 4C 60W  
 Clear Water Glass  
 Clear Glass

**F. 7-1804-4-B9**  
 4-Light Pendant  
 Matte Black Finish  
 18"W x 39-1/2"H  
 4C 60W  
 Clear Water Glass



Scence, Page 235

# CRAWFORD



# CRAWFORD



A.



B.

**A. 6-1802-3-89**  
 3-Light Semi-Flush  
 Matte Black Finish  
 15"W x 13-1/2"H  
 3C 60W  
 Clear Water Glass

**B. 6-1802-3-322**  
 3-Light Semi-Flush  
 Warm Brass Finish  
 15"W x 13-1/2"H  
 3C 60W  
 Clear Water Glass

**C. 6-1802-3-SN**  
 3-Light Semi-Flush  
 Satin Nickel Finish  
 15"W x 13-1/2"H  
 3C 60W  
 Clear Water Glass



C.

# CALHOUN



\*Includes 120" chain & wire

\*\*Includes 12" & 6" extensions - additional stems available - 7-EXT

# CALHOUN



Dual Mount Hanging System



\*A.



\*B.

**A. 1-1021-5-89**

5-Light Chandelier  
Matte Black Finish  
25"W x 23"H  
5E 60W  
Clear Glass

**B. 7-1025-3-89**

3-Light Pendant  
Matte Black Finish  
15"W x 18"H  
3E 60W  
Clear Glass

**C. 1-1023-5-89**

5-Light Linear Chandelier  
Matte Black Finish  
40"L x 5"W x 10"H  
Adj H 10' - 62'  
5E 60W  
Clear Glass



\*\*C.



Mini-Pendant, Page 181



Pendant, Page 181



Ceiling, Page 204



Bath, Page 251

# CALHOUN



\*A.



\*B.



Dual Mount Hanging System



\*\*C.

**A. 7-1025-3-SN**  
 3-Light Pendant  
 Satin Nickel Finish  
 15"W x 18"H  
 3E 60W  
 Clear Glass

**B. 1-1021-5-SN**  
 5-Light Chandelier  
 Satin Nickel Finish  
 25"W x 22"H  
 5E 60W  
 Clear Glass

**C. 1-1023-5-SN**  
 5-Light Linear Chandelier  
 Satin Nickel Finish  
 40"L x 5"W x 10"H  
 Adj H 10" - 62"  
 5E 60W  
 Clear Glass

\*Includes 120" chain & wire.



Mini-Pendant, Page 181



Pendant, Page 181



Ceiling, Page 204



Bath, Page 251



# CALHOUN



Dual Mount Hanging System



\*D.



\*E.

**D. 1-1021-5-322**  
 5-Light Chandelier  
 Warm Brass Finish  
 25"W x 22"H  
 5E 60W  
 Clear Glass

**E. 7-1025-3-322**  
 3-Light Pendant  
 Warm Brass Finish  
 15"W x 18"H  
 3E 60W  
 Clear Glass

**F. 1-1023-5-322**  
 5-Light Linear Chandelier  
 Warm Brass Finish  
 40"L x 5"W x 10"H  
 Adj H 10" - 62"  
 5E 60W  
 Clear Glass



\*\*F.

\*\*Includes 12" & 6" extensions - additional stems available - 7-EXT



Mini-Pendant, Page 181



Pendant, Page 181



Ceiling, Page 204



Bath, Page 251

# OCTAVE



Pendant, Page 185



Ceiling, Page 198



Ceiling, Page 199



Bath, Page 267



Sconce, Page 268

# OCTAVE



**A. 7-4034-3-322**  
 3-Light Pendant  
 Warm Brass Finish  
 15"W x 18"H  
 3E 60W  
 Clear Glass

**B. 1-4032-5-322**  
 5-Light Chandelier  
 Warm Brass Finish  
 23"W x 18-1/2"H  
 5E 60W  
 Clear Glass

**C. 1-4032-5-BK**  
 5-Light Chandelier  
 Matte Black Finish  
 23"W x 18-1/2"H  
 5E 60W  
 Clear Glass

**D. 7-4034-3-BK**  
 3-Light Pendant  
 Matte Black Finish  
 15"W x 18"H  
 3E 60W  
 Clear Glass

**E. 1-4033-9-BK**  
 9-Light Chandelier  
 Matte Black Finish  
 30"W x 28"H  
 9E 60W  
 Clear Glass

Includes 120" chain & wire

# OCTAVE



**A. 7-4034-3-SN**  
 3-Light Pendant  
 Satin Nickel Finish  
 15"W x 18"H  
 3E 60W  
 Clear Glass

**B. 1-4033-9-SN**  
 9-Light Chandelier  
 Satin Nickel Finish  
 30"W x 28"H  
 9E 60W  
 Clear Glass

**C. 1-4032-5-SN**  
 5-Light Chandelier  
 Satin Nickel Finish  
 23"W x 18-1/2"H  
 5E 60W  
 Clear Glass



Pendant, Page 185



Ceiling, Page 198



Ceiling, Page 199



Bath, Page 269



Sconce, Page 245

# OCTAVE



D.



E.



F.



G.

**D. 1-4032-5-13**  
 5-Light Chandelier  
 English Bronze Finish  
 23"W x 18-1/2"H  
 5E 60W  
 Clear Glass

**E. 7-4034-3-13**  
 3-Light Pendant  
 English Bronze Finish  
 15"W x 18"H  
 3E 60W  
 Clear Glass

**F. 7-4034-3-11**  
 3-Light Pendant  
 Polished Chrome Finish  
 15"W x 18"H  
 3E 60W  
 Clear Glass

**G. 1-4032-5-11**  
 5-Light Chandelier  
 Polished Chrome Finish  
 23"W x 18-1/2"H  
 5E 60W  
 Clear Glass



Pendant, Page 185



Bath, Page 268



Ceiling, Page 199



Ceiling, Page 198



Sconce, Page 245

Includes 120" chain & wire

# COLTON



# COLTON



**A. 7-336-1-SN**  
1-Light Mini-Pendant  
Satin Nickel Finish  
6-1/2"W x 14-1/2"H  
1E 60W  
White Opal Glass



**B. 1-330-5-SN**  
5-Light Chandelier  
Satin Nickel Finish  
26"W x 26"H  
5E 60W  
White Opal Glass

Includes 120" chain & wire



Bath, Page 293



Sconce, Page 244

# HERNDON

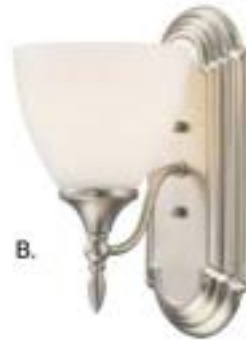



# HERNDON

- A. 1-1001-5-SN**  
5-Light Chandelier  
Satin Nickel Finish  
26"W x 27-1/2"H  
5E 60W  
Frosted White Glass

- B. 9-1007-1-SN**  
1-Light Sconce  
Satin Nickel Finish  
5-1/2"W x 10-3/4"H x  
7-1/2"E  
1E 60W  
Frosted White Glass

- C. 6-1005-3-SN**  
3-Light Semi-Flush  
Satin Nickel Finish  
18"W x 15-1/2"H  
3E 60W  
Frosted White Glass

- D. 7-1003-3-SN**  
3-Light Pendant  
Satin Nickel Finish  
16"W x 34"H  
3E 60W  
Frosted White Glass

- E. 1-1000-3-SN**  
3-Light Chandelier  
Satin Nickel Finish  
18-1/2"W x 15"H  
3E 60W  
Frosted White Glass

- F. 7-1004-3-SN**  
3-Light Pendant  
Satin Nickel Finish  
18"W x 22"H  
3E 60W  
Frosted White Glass

- G. 1-1008-5-SN**  
5-Light Chandelier  
Satin Nickel Finish  
21"W x 27-1/2"H  
5C 60W  
White Candle Covers



\*Includes 120' chain & wire



Pendant, Page 183



Bath, Page 294

# TOWNSEND



- |                       |                      |                       |                        |                      |
|-----------------------|----------------------|-----------------------|------------------------|----------------------|
| <b>A. 3-420-3-44</b>  | <b>B. 3-420-3-5N</b> | <b>C. 3-420-3-322</b> | <b>D. 3-420-3-109</b>  | <b>E. 3-420-3-89</b> |
| 3-Light Pendant       | 3-Light Pendant      | 3-Light Pendant       | 3-Light Pendant        | 3-Light Pendant      |
| Classic Bronze Finish | Satin Nickel Finish  | Warm Brass Finish     | Polished Nickel Finish | Matte Black Finish   |
| 10"W x 15"H           | 10"W x 15"H          | 10"W x 15"H           | 10"W x 15"H            | 10"W x 15"H          |
| 3C 60W                | 3C 60W               | 3C 60W                | 3C 60W                 | 3C 60W               |
| Metal Candle Covers   | Metal Candle Covers  | Metal Candle Covers   | Metal Candle Covers    | Metal Candle Covers  |

# TOWNSEND



Includes 120" chain & wire

# TOWNSEND

---

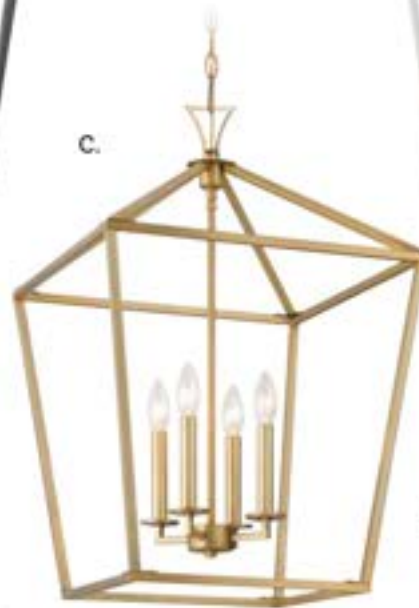
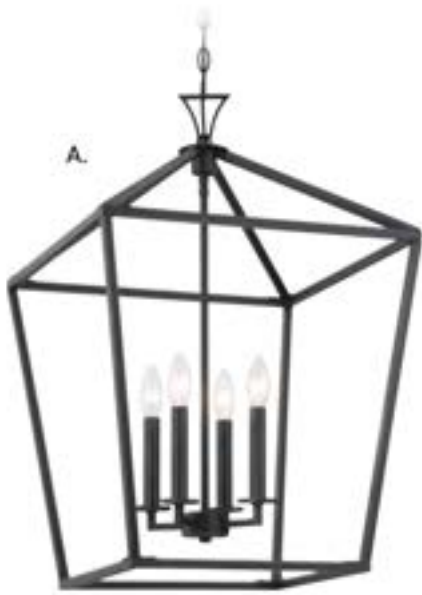

Includes 120' chain & wire

# TOWNSEND

**A. 3-421-4-44**

4-Light Pendant  
Classic Bronze Finish  
17"W x 26"H  
4C 60W  
Metal Candle Covers

**B. 3-421-4-SN**

4-Light Pendant  
Satin Nickel Finish  
17"W x 26"H  
4C 60W  
Metal Candle Covers

**C. 3-421-4-322**

4-Light Pendant  
Warm Brass Finish  
17"W x 26"H  
4C 60W  
Metal Candle Covers

**D. 3-421-4-109**

4-Light Pendant  
Polished Nickel Finish  
17"W x 26"H  
4C 60W  
Metal Candle Covers

**E. 3-421-4-89**

4-Light Pendant  
Matte Black Finish  
17"W x 26"H  
4C 60W  
Metal Candle Covers

# TOWNSEND



Includes 120' chain & wire

116 SAVOYHOUSE.COM | 800 801 1621

# TOWNSEND

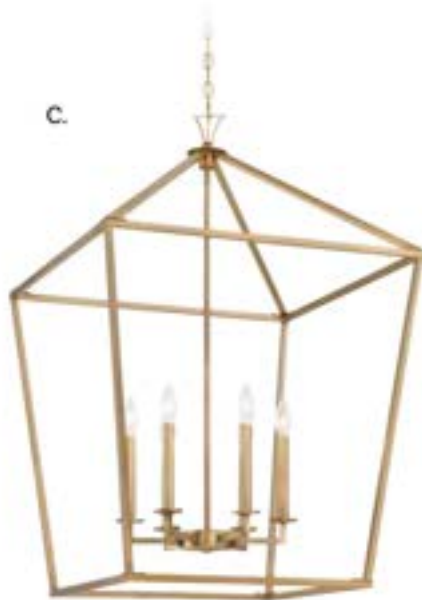
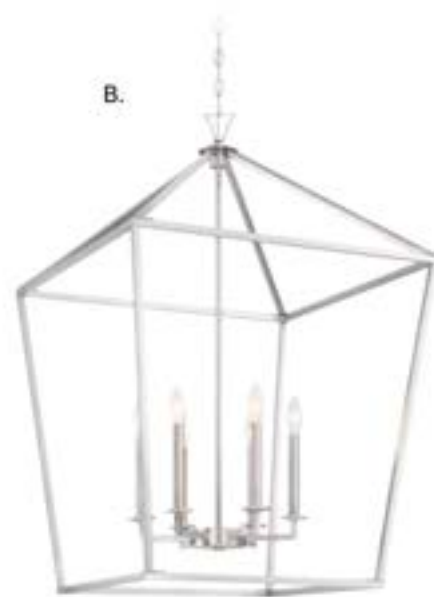

**A. 3-422-6-44**  
6-Light Pendant  
Classic Bronze Finish  
24"W x 36-1/2"H  
6C 60W  
Metal Candle Covers

**B. 3-422-6-SN**  
6-Light Pendant  
Satin Nickel Finish  
24"W x 36-1/2"H  
6C 60W  
Metal Candle Covers

**C. 3-422-6-322**  
6-Light Pendant  
Warm Brass Finish  
24"W x 36-1/2"H  
6C 60W  
Metal Candle Covers

**D. 3-422-6-89**  
6-Light Pendant  
Matte Black Finish  
24"W x 36-1/2"H  
6C 60W  
Metal Candle Covers

# TOWNSEND

---





# TOWNSEND



- |   |   |  |   |  |
|---|---|--|---|--|
| <p><b>A. 6-328-4-44</b><br/>4-Light Semi-Flush<br/>Classic Bronze Finish<br/>13"W x 13"H<br/>4C 60W<br/>Metal Candle Covers</p> | <p><b>B. 6-328-4-5N</b><br/>4-Light Semi-Flush<br/>Satin Nickel Finish<br/>13"W x 13"H<br/>4C 60W<br/>Metal Candle Covers</p> | <p><b>C. 6-328-4-322</b><br/>4-Light Semi-Flush<br/>Warm Brass Finish<br/>13"W x 13"H<br/>4C 60W<br/>Metal Candle Covers</p> | <p><b>D. 6-328-4-109</b><br/>4-Light Semi-Flush<br/>Polished Nickel Finish<br/>13"W x 13"H<br/>4C 60W<br/>Metal Candle Covers</p> | <p><b>E. 6-328-4-89</b><br/>4-Light Semi-Flush<br/>Matte Black Finish<br/>13"W x 13"H<br/>4C 60W<br/>Metal Candle Covers</p> |
|---|---|--|---|--|

# TOWNSEND



Includes 120' chain & wire

120 SAVOYHOUSE.COM | 800 801 1621

# TOWNSEND

A.



- A. 1-423-3-322**  
3-Light Linear  
Chandelier  
Warm Brass Finish  
32"L x 16"W x 21"H  
3C 60W  
Metal Candle Covers

B.

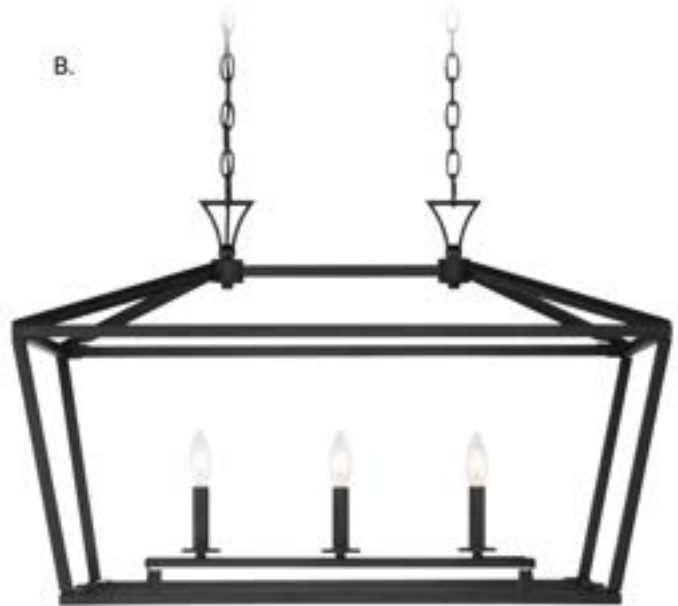

- B. 1-423-3-89**  
3-Light Linear  
Chandelier  
Matte Black Finish  
32"L x 16"W x 21"H  
3C 60W  
Metal Candle Covers

# TOWNSEND

---

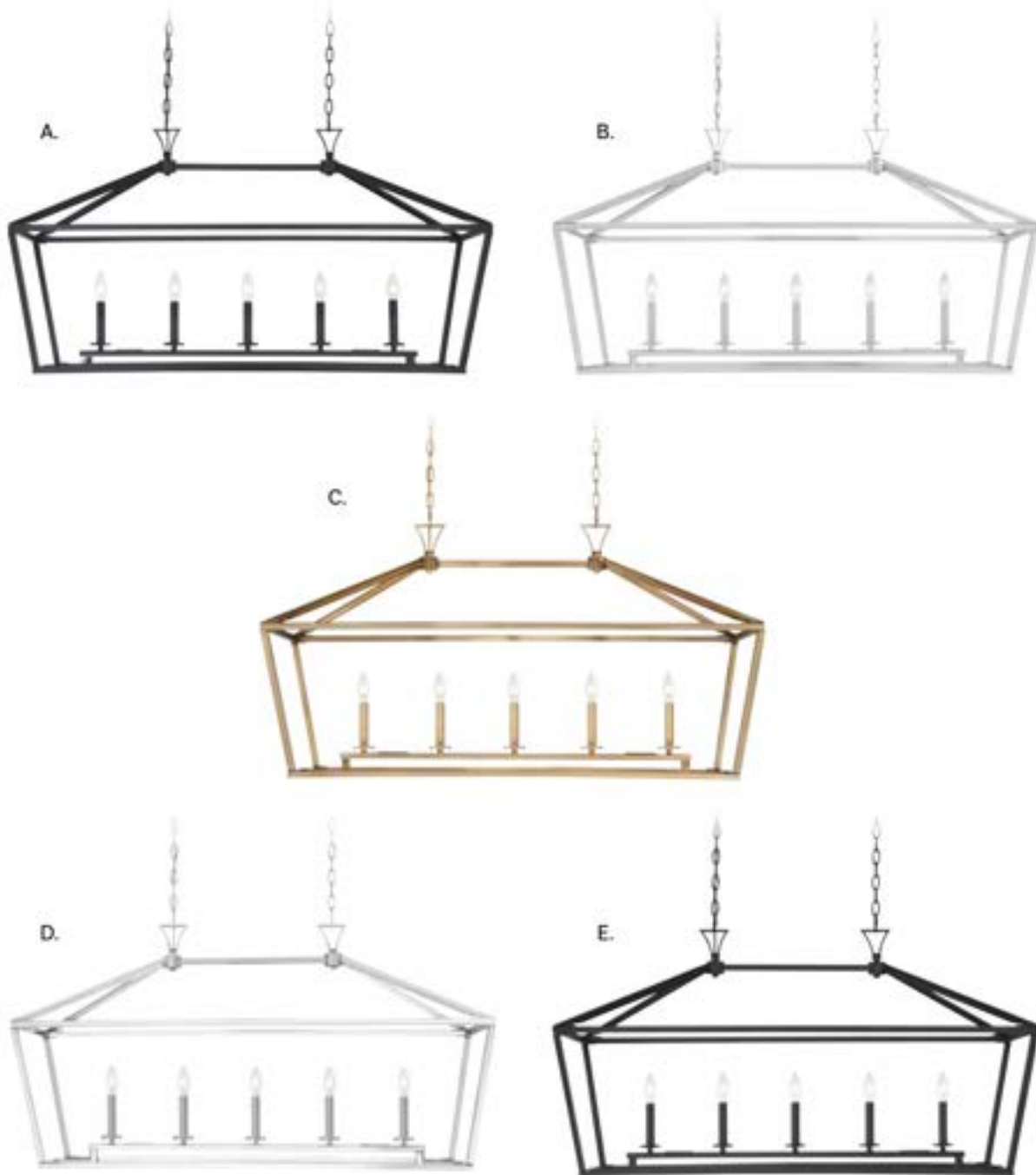

Includes 120' chain & wire

# TOWNSEND



- |                        |                        |                        |                        |                        |
|------------------------|------------------------|------------------------|------------------------|------------------------|
| <b>A. 1-424-5-44</b>   | <b>B. 1-424-5-5N</b>   | <b>C. 1-424-5-322</b>  | <b>D. 1-424-5-109</b>  | <b>E. 1-424-5-89</b>   |
| 5-Light Linear         | 5-Light Linear         | 5-Light Linear         | 5-Light Linear         | 5-Light Linear         |
| Chandelier             | Chandelier             | Chandelier             | Chandelier             | Chandelier             |
| Classic Bronze Finish  | Satin Nickel Finish    | Warm Brass Finish      | Polished Nickel Finish | Matte Black Finish     |
| 44"L x 16"W x 23-1/2"H | 44"L x 16"W x 23-1/2"H | 44"L x 16"W x 23-1/2"H | 44"L x 16"W x 23-1/2"H | 44"L x 16"W x 23-1/2"H |
| 5C 60W                 | 5C 60W                 | 5C 60W                 | 5C 60W                 | 5C 60W                 |
| Metal Candle Covers    | Metal Candle Covers    | Metal Candle Covers    | Metal Candle Covers    | Metal Candle Covers    |

# PALLADIAN

---

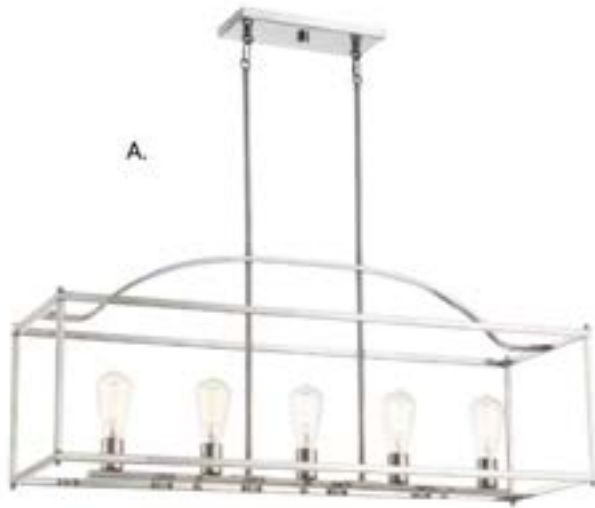

Dual Mount Hanging System

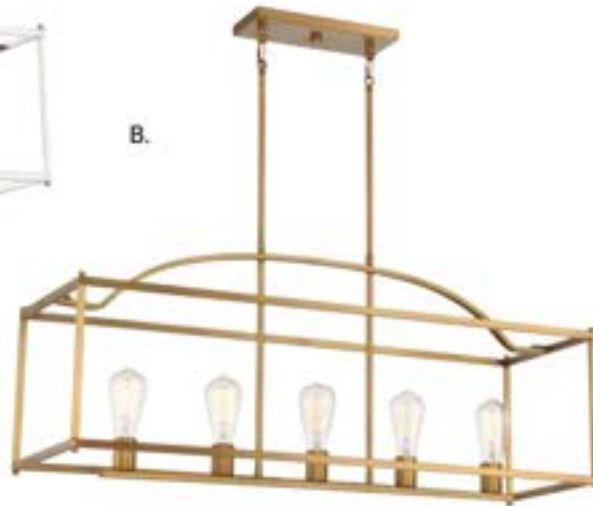

Includes 12' & 6" extensions - additional stems available - 7-EXT

# PALLADIAN

**A. 1-190-5-109**

5-Light Linear Chandelier  
Polished Nickel Finish  
38"L x 12"W x 16"H  
Adj H 16" - 70"  
5E 60W

**B. 1-190-5-322**

5-Light Linear Chandelier  
Warm Brass Finish  
38"L x 12"W x 16"H  
Adj H 16" - 70"  
5E 60W

**C. 1-190-5-SN**

5-Light Linear Chandelier  
Satin Nickel Finish  
38"L x 12"W x 16"H  
Adj H 16" - 70"  
5E 60W

**D. 1-190-5-89**

5-Light Linear Chandelier  
Matte Black Finish  
38"L x 12"W x 16"H  
Adj H 16" - 70"  
5E 60W

# DENTON

**A. 1-326-3-322**

3-Light Linear Chandelier  
 Warm Brass Finish  
 32"L x 12"W x 10-1/2"H  
 Adj H 10-1/2' - 65-1/2'  
 3E 60W  
 30° Swivel

**B. 1-326-3-44**

3-Light Linear Chandelier  
 Classic Bronze Finish  
 32"L x 12"W x 10-1/2"H  
 Adj H 10-1/2' - 65-1/2'  
 3E 60W  
 30° Swivel

**C. 1-327-5-322**

5-Light Linear Chandelier  
 Warm Brass Finish  
 44"L x 12"W x 10-1/2"H  
 Adj H 10-1/2' - 65-1/2'  
 5E 60W  
 30° Swivel

**D. 1-327-5-44**

5-Light Linear Chandelier  
 Classic Bronze Finish  
 44"L x 12"W x 10-1/2"H  
 Adj H 10-1/2' - 65-1/2'  
 5E 60W  
 30° Swivel





# DENTON

---



Includes 12" & 6" extensions - additional stems available - 7-EXT

# DIPLOMAT



Includes 12" & 6" extensions - additional stems available - 7-EXT

128 SAVOYHOUSE.COM | 800 801 1621

# DIPLOMAT

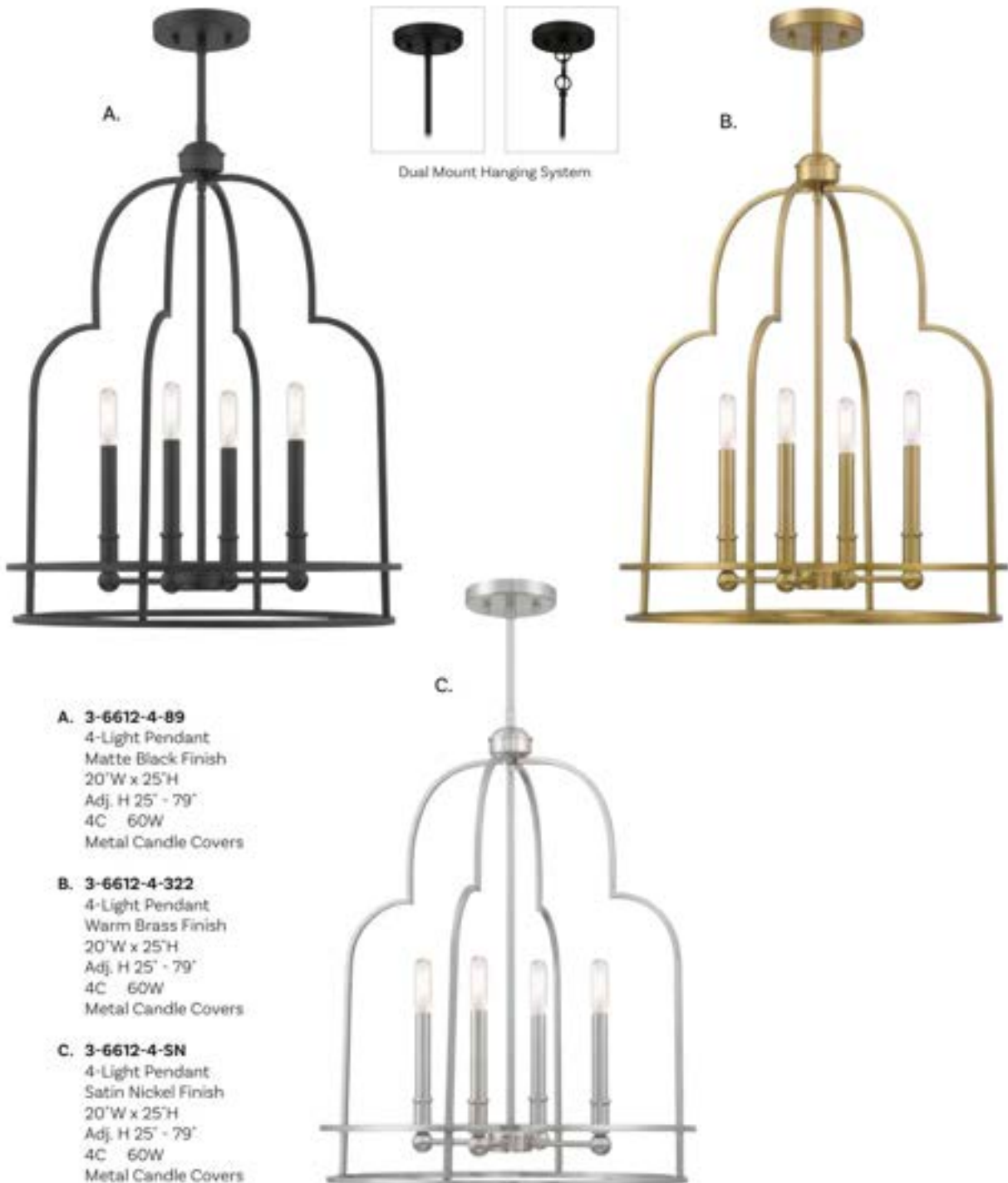

# BENSON



Dual Mount Hanging System

- A. 6-7702-3-89**  
3-Light Semi-Flush  
Matte Black Finish  
13"W x 12"H  
3C 60W  
Metal Candle Covers
- B. 6-7702-3-322**  
3-Light Semi-Flush  
Warm Brass Finish  
13"W x 12"H  
3C 60W  
Metal Candle Covers
- C. 6-7702-3-5N**  
3-Light Semi-Flush  
Satin Nickel Finish  
13"W x 12"H  
3C 60W  
Metal Candle Covers
- D. 3-7700-3-89**  
3-Light Pendant  
Matte Black Finish  
13"W x 16-1/2"H  
Adj H 16-1/2" - 70-1/2"  
3C 60W  
Metal Candle Covers
- E. 3-7700-3-322**  
3-Light Pendant  
Warm Brass Finish  
13"W x 16-1/2"H  
Adj H 16-1/2" - 70-1/2"  
3C 60W  
Metal Candle Covers
- F. 3-7700-3-5N**  
3-Light Pendant  
Satin Nickel Finish  
13"W x 16-1/2"H  
Adj H 16-1/2" - 70-1/2"  
3C 60W  
Metal Candle Covers
- G. 3-7701-5-89**  
5-Light Pendant  
Matte Black Finish  
16"W x 20-1/2"H  
Adj H 20-1/2" - 74-1/2"  
5C 60W  
Metal Candle Covers
- H. 3-7701-5-322**  
5-Light Pendant  
Warm Brass Finish  
16"W x 20-1/2"H  
Adj H 20-1/2" - 74-1/2"  
5C 60W  
Metal Candle Covers
- I. 3-7701-5-5N**  
5-Light Pendant  
Satin Nickel Finish  
16"W x 20-1/2"H  
Adj H 20-1/2" - 74-1/2"  
5C 60W  
Metal Candle Covers

# BENSON



A.



B.



C.



\*D.



\*E.



\*F.



\*G.



\*H.



\*L.

\*Includes 12" & 6" extensions - additional stems available - 7-EXT

# KENT

- A. 6-4900-4-322**  
4-Light Semi-Flush  
Warm Brass Finish  
16"W x 14-3/4"H  
4E 60W  
Metal Candle Covers
- B. 6-4900-4-89**  
4-Light Semi-Flush  
Matte Black Finish  
16"W x 14-3/4"H  
4E 60W  
Metal Candle Covers
- C. 6-4900-4-5N**  
4-Light Semi-Flush  
Satin Nickel Finish  
16"W x 14-3/4"H  
4E 60W  
Metal Candle Covers
- D. 3-4901-4-322**  
4-Light Pendant  
Warm Brass Finish  
16"W x 24"H  
Adj H 24" - 81"  
4C 60W  
30° Swivel  
Metal Candle Covers
- E. 3-4901-4-89**  
4-Light Pendant  
Matte Black Finish  
16"W x 24"H  
Adj H 24" - 81"  
4C 60W  
30° Swivel  
Metal Candle Covers
- F. 3-4901-4-5N**  
4-Light Pendant  
Satin Nickel Finish  
16"W x 24"H  
Adj H 24" - 81"  
4C 60W  
30° Swivel  
Metal Candle Covers



# KENT



Includes 12" & 6" extensions - additional stems available - 7-EXT

# PENROSE



\*Includes 120" chain & wire

134 SAVOYHOUSE.COM | 800 801 1621



# PENROSE



A.



B.



C.



D.

**A. 7-1041-6-109**  
 6-Light Pendant  
 Polished Nickel Finish  
 16"W x 34"H  
 6C 60W  
 Clear Glass  
 Metal Candle Covers

**B. 7-1041-6-5N**  
 6-Light Pendant  
 Satin Nickel Finish  
 16"W x 34"H  
 6C 60W  
 Clear Glass  
 Metal Candle Covers

**C. 7-1041-6-BK**  
 6-Light Pendant  
 Matte Black Finish  
 16"W x 34"H  
 6C 60W  
 Clear Glass  
 Metal Candle Covers

**D. 7-1041-6-13**  
 6-Light Pendant  
 English Bronze Finish  
 16"W x 34"H  
 6C 60W  
 Clear Glass  
 Metal Candle Covers

# PENROSE

**A. 6-1043-3-13**

3-Light Semi-Flush  
English Bronze Finish  
12-1/2"W x 14"H  
3C 60W  
Clear Glass  
Metal Candle Covers

**B. 6-1043-3-109**

3-Light Semi-Flush  
Polished Nickel Finish  
12-1/2"W x 14"H  
3C 60W  
Clear Glass  
Metal Candle Covers

**C. 6-1043-3-BK**

3-Light Semi-Flush  
Matte Black Finish  
12-1/2"W x 14"H  
3C 60W  
Clear Glass  
Metal Candle Covers

**D. 7-1040-3-13**

3-Light Pendant  
English Bronze Finish  
12"W x 26"H  
3C 60W  
Clear Glass  
Metal Candle Covers

**E. 7-1040-3-109**

3-Light Pendant  
Polished Nickel Finish  
12"W x 26"H  
3C 60W  
Clear Glass  
Metal Candle Covers

# PENROSE

G.



\*H.



**F. 7-1040-3-BK**  
3-Light Pendant  
Matte Black Finish  
12"W x 26"H  
3C 60W  
Clear Glass  
Metal Candle Covers

**G. 6-1043-3-SN**  
3-Light Semi-Flush  
Satin Nickel Finish  
12-1/2"W x 14"H  
3C 60W  
Clear Glass  
Metal Candle Covers

**H. 7-1040-3-SN**  
3-Light Pendant  
Satin Nickel Finish  
12"W x 26"H  
3C 60W  
Clear Glass  
Metal Candle Covers

\*Includes 120' chain & wire

# GALEA

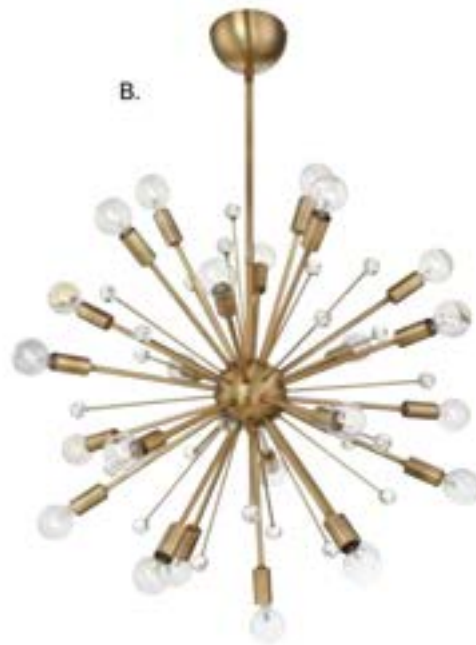

**A. 7-6099-24-109**  
 24-Light Pendant  
 Polished Nickel Finish  
 23"W x 23"H  
 Adj H 23" - 71-1/2"  
 24C 25W  
 30° Swivel  
 K9 Crystal Accents

**B. 7-6099-24-322**  
 24-Light Pendant  
 Warm Brass Finish  
 23"W x 23"H  
 Adj H 23" - 71-1/2"  
 24C 25W  
 30° Swivel  
 K9 Crystal Accents

**C. 7-6099-24-89**  
 24-Light Pendant  
 Matte Black Finish  
 23"W x 23"H  
 Adj H 23" - 71-1/2"  
 24C 25W  
 30° Swivel  
 K9 Crystal Accents

# GALEA



Includes 12" & 6" extensions - additional stems available - 7-EXT

# SEAGRAM



# SEAGRAM



Includes 12" & 6" extensions - additional stems available - 7-EXTLG

# ALDEN



**A. 7-232-1-109**  
1-Light Pendant  
Polished Nickel Finish  
12"W x 8-1/2"H  
Adj H 8-1/2" - 30"  
1E 60W

**B. 7-232-1-323**  
1-Light Pendant  
Old Bronze Finish  
12"W x 8-1/2"H  
Adj H 8-1/2" - 30"  
1E 60W

**C. 7-231-1-109**  
1-Light Pendant  
Polished Nickel Finish  
18-1/4"W x 12-1/2"H  
Adj H 12-1/2" - 33-3/4"  
1E 60W

**D. 7-231-1-323**  
1-Light Pendant  
Old Bronze Finish  
18-1/4"W x 12-1/2"H  
Adj H 12-1/2" - 33-3/4"  
1E 60W

**E. 7-232-1-322**  
1-Light Pendant  
Warm Brass Finish  
12"W x 8-1/2"H  
Adj H 8-1/2" - 30"  
1E 60W

**F. 7-232-1-89**  
1-Light Pendant  
Matte Black Finish  
12"W x 8-1/2"H  
Adj H 8-1/2" - 30"  
1E 60W

**G. 7-231-1-322**  
1-Light Pendant  
Warm Brass Finish  
18-1/4"W x 12-1/2"H  
Adj H 12-1/2" - 33-3/4"  
1E 60W

**H. 7-231-1-89**  
1-Light Pendant  
Matte Black Finish  
18-1/4"W x 12-1/2"H  
Adj H 12-1/2" - 33-3/4"  
1E 60W

Includes (2) sections of 9-1/2" decorative linked stems, plus 120" chain & wire.



# ALDEN



# BERG



**A. 6-3750-1-89**  
1-Light Semi-Flush  
Matte Black Finish  
12"W x 12"H  
1E 60W

**B. 6-3750-1-322**  
1-Light Semi-Flush  
Warm Brass Finish  
12"W x 12"H  
1E 60W

\*Includes 9-1/2" extensions - additional stems available - **7-EXT**

# BERG



**C. 7-3751-1-109**  
 1-Light Pendant  
 Polished Nickel Finish  
 12"W x 14"H  
 Adj H 14" - 45-1/2"  
 1E 60W  
 90° Swivel

**D. 7-3751-1-89**  
 1-Light Pendant  
 Matte Black Finish  
 12"W x 14"H  
 Adj H 14" - 45-1/2"  
 1E 60W  
 90° Swivel

**E. 7-3751-1-SN**  
 1-Light Pendant  
 Satin Nickel Finish  
 12"W x 14"H  
 Adj H 14" - 45-1/2"  
 1E 60W  
 90° Swivel

**F. 7-3751-1-322**  
 1-Light Pendant  
 Warm Brass Finish  
 12"W x 14"H  
 Adj H 14" - 45-1/2"  
 1E 60W  
 90° Swivel

**G. 7-3751-1-13**  
 1-Light Pendant  
 English Bronze Finish  
 12"W x 14"H  
 Adj H 14" - 45-1/2"  
 1E 60W  
 90° Swivel

# WILLIS



# WILLIS



Includes 12" & 6" extensions - additional stems available - 7-EXT

# KOLE



Dual Mount Hanging System

**A. 3-1617-4-11**  
 4-Light Pendant  
 Polished Chrome Finish  
 14"W x 21"H  
 Adj H 21" - 75"  
 4C 60W  
 Laser Cut Glass

**B. 3-1617-4-322**  
 4-Light Pendant  
 Warm Brass Finish  
 14"W x 21"H  
 Adj H 21" - 75"  
 4C 60W  
 Laser Cut Glass

**C. 3-1617-4-89**  
 4-Light Pendant  
 Matte Black Finish  
 14"W x 21"H  
 Adj H 21" - 75"  
 4C 60W  
 Laser Cut Glass

# KOLE



Includes 12" & 6" extensions - additional stems available - 7-EXT

# FOSTER

---



Includes 12" & 6" extensions - additional stems available - 7-EXT



# FOSTER



**A. 7-7006-1-89**  
 1-Light Pendant  
 Matte Black Finish  
 14"W x 25-1/2"H  
 1E 60W  
 Clear Seeded Glass

**B. 7-7006-1-322**  
 1-Light Pendant  
 Warm Brass Finish  
 14"W x 25-1/2"H  
 1E 60W  
 Clear Seeded Glass

**C. 7-7006-1-SN**  
 1-Light Pendant  
 Satin Nickel Finish  
 14"W x 25-1/2"H  
 1E 60W  
 Clear Seeded Glass



Scence, Page 234

# BRANDON



Includes 12" & 6" extensions - additional stems available - 7-EXT

152 SAVOYHOUSE.COM | 800 801 1621

# BRANDON



Dual Mount Hanging System

**A. 7-2255-1-322**  
 1-Light Pendant  
 Warm Brass Finish  
 14"W x 22"H  
 Adj H 22" - 74"  
 1E 60W  
 30" Swivel  
 Clear Fluted Glass

**B. 7-2255-1-89**  
 1-Light Pendant  
 Matte Black Finish  
 14"W x 22"H  
 Adj H 22" - 74"  
 1E 60W  
 30" Swivel  
 Clear Fluted Glass

**C. 7-2255-1-SN**  
 1-Light Pendant  
 Satin Nickel Finish  
 14"W x 22"H  
 Adj H 22" - 74"  
 1E 60W  
 30" Swivel  
 Clear Fluted Glass

# BRISTO



Includes 12" & 6" extensions - additional stems available - 7-EXT

154 SAVOYHOUSE.COM | 800 801 1621

# BRISTO



Dual Mount Hanging System

**A. 7-2265-1-SN**  
 1-Light Pendant  
 Satin Nickel Finish  
 14"W x 20"H  
 Adj H 20" - 72"  
 1E 60W  
 Clear Fluted Glass

**B. 7-2265-1-322**  
 1-Light Pendant  
 Warm Brass Finish  
 14"W x 20"H  
 Adj H 20" - 72"  
 1E 60W  
 Clear Fluted Glass

**C. 7-2265-1-89**  
 1-Light Pendant  
 Matte Black Finish  
 14"W x 20"H  
 Adj H 20" - 72"  
 1E 60W  
 Clear Fluted Glass

# WELLES



Includes 12' & 6' extensions - additional stems available - 7-EXT

156 SAVOYHOUSE.COM | 800 801 1621

# WELLES



Dual Mount Hanging System

**A. 7-170-1-11**  
 1-Light Pendant  
 Polished Chrome Finish  
 12"W x 14-1/2"H  
 Adj H 14-1/2" - 68-1/2"  
 1E 60W  
 Clear Ribbed Glass

**B. 7-170-1-89**  
 1-Light Pendant  
 Matte Black Finish  
 12"W x 14-1/2"H  
 Adj H 14-1/2" - 68-1/2"  
 1E 60W  
 Clear Ribbed Glass

**C. 7-170-1-322**  
 1-Light Pendant  
 Warm Brass Finish  
 12"W x 14-1/2"H  
 Adj H 14-1/2" - 68-1/2"  
 1E 60W  
 Clear Ribbed Glass

# MANOR



**A. 7-3901-3-89**  
3-Light Pendant  
Matte Black Finish  
13-1/2"W x 31"H  
3C 60W

**B. 7-3901-3-109**  
3-Light Pendant  
Polished Nickel Finish  
13-1/2"W x 31"H  
3C 60W

**C. 7-3901-3-322**  
3-Light Pendant  
Warm Brass Finish  
13-1/2"W x 31"H  
3C 60W



# MANOR



Includes 120" chain & wire

# BRISTOL



Includes 12" & 6" extensions - additional stems available - 7-EXT

160 SAVOYHOUSE.COM | 800 801 1621

# BRISTOL



Dual Mount Hanging System

**A. 7-8840-1-B9**

1-Light Pendant  
 Matte Black Finish  
 9"W x 15"H  
 Adj H 15" - 69"  
 1E 60W  
 Fluted White Opal Glass

**B. 7-8840-1-SN**

1-Light Pendant  
 Satin Nickel Finish  
 9"W x 15"H  
 Adj H 15" - 69"  
 1E 60W  
 Fluted White Opal Glass

**C. 7-8840-1-322**

1-Light Pendant  
 Warm Brass Finish  
 9"W x 15"H  
 Adj H 15" - 69"  
 1E 60W  
 Fluted White Opal Glass

# AUSTIN



Includes 120" chain & wire

162 SAVOYHOUSE.COM | 800 801 1621

# AUSTIN



A.



C.



B.

**A. 7-2201-4-13**  
4-Light Pendant  
English Bronze Finish  
18"W x 32-1/2"H  
4C 60W  
White Fabric Shade

**B. 7-2201-4-322**  
4-Light Pendant  
Warm Brass Finish  
18"W x 32-1/2"H  
4C 60W  
White Fabric Shade

**C. 7-2201-4-SN**  
4-Light Pendant  
Satin Nickel Finish  
18"W x 32-1/2"H  
4C 60W  
White Fabric Shade

# MANSFIELD

---



Includes 120' chain & wire

---

164 SAVOYHOUSE.COM | 800 801 1621

# MANSFIELD

**A. 7-1875-3-13**

3-Light Pendant  
English Bronze Finish  
18"W x 21"H  
3E 60W  
White Fabric Shade

**B. 7-1875-3-322**

3-Light Pendant  
Warm Brass Finish  
18"W x 21"H  
3E 60W  
White Fabric Shade

**C. 7-1875-3-89**

3-Light Pendant  
Matte Black Finish  
18"W x 21"H  
3E 60W  
White Fabric Shade

**D. 7-1875-3-11**

3-Light Pendant  
Polished Chrome Finish  
18"W x 21"H  
3E 60W  
White Fabric Shade

# BECKER

---



Includes (2) 9-1/2" extensions - additional stems available - 7-EXT

---

166 SAVOYHOUSE.COM | 800 801 1621



# BECKER



Dual Mount Hanging System

**A. 7-180-1-322**  
 1-Light Pendant  
 Warm Brass Finish  
 10"W x 27-1/2"H  
 Adj H 27-1/2" - 37"  
 1E 60W  
 White Glass

**B. 7-180-1-5N**  
 1-Light Pendant  
 Satin Nickel Finish  
 10"W x 27-1/2"H  
 Adj H 27-1/2" - 37"  
 1E 60W  
 White Glass

**C. 7-180-1-109**  
 1-Light Pendant  
 Polished Nickel Finish  
 10"W x 27-1/2"H  
 Adj H 27-1/2" - 37"  
 1E 60W  
 White Glass

**D. 7-180-1-89**  
 1-Light Pendant  
 Matte Black Finish  
 10"W x 27-1/2"H  
 Adj H 27-1/2" - 37"  
 1E 60W  
 White Glass

# GARVEY



\*A.



\*B.



\*C.



**A. 7-5012-1-322**  
 1-Light Pendant  
 Warm Brass Finish  
 14"W x 16-1/2"H  
 Adj H 16-1/2" - 48"  
 1E 60W  
 Clear Glass

**B. 7-5012-1-13**  
 1-Light Pendant  
 English Bronze Finish  
 14"W x 16-1/2"H  
 Adj H 16-1/2" - 48"  
 1E 60W  
 Clear Glass

**C. 7-5012-1-109**  
 1-Light Pendant  
 Polished Nickel Finish  
 14"W x 16-1/2"H  
 Adj H 16-1/2" - 48"  
 1E 60W  
 Clear Glass

\*Includes 9-1/2" extensions - additional stems available - 7-EXT

# STIRLING/WESTBOURNE

**D. STIRLING****7-200-3-57**

3-Light Pendant

Polished Pewter Finish

12"W x 13"H

Adj H 13"H - 70"

3C 60W

Crackled Glass

Metal Candle Cover

**E. STIRLING****7-200-3-322**

3-Light Pendant

Warm Brass Finish

12"W x 13"H

Adj H 13"H - 70"

3C 60W

Crackled Glass

Metal Candle Covers

**F. WESTBOURNE****7-3102-1-322**

1-Light Pendant

Warm Brass Finish

12-3/4"W x 16-1/2"H

Adj H 16-1/2" - 73-1/2"

1E 60W

White Opal Glass

**G. WESTBOURNE****7-3100-1-322**

1-Light Pendant

Warm Brass Finish

8-3/4"W x 11-1/2"H

Adj H 11-1/2" - 43"

1E 60W

White Opal Glass

\*\*Includes 12" & 6" extensions - additional stems available - **7-EXT**

# DUNBAR



Includes 12" & 6" extensions - additional stems available - 7-EXT

170 SAVOYHOUSE.COM | 800-801-1621

# DUNBAR

  
**BRIAN THOMAS**  
 COLLECTION

**A. 7-9064-1-67**  
 1-Light Mini-Pendant  
 Matte Black w/ Polished  
 Chrome Accents  
 4-3/4"W x 7"H  
 Adj H 7" - 42-1/2"  
 1C 60W  
 Clear Glass

**B. 7-9064-1-95**  
 1-Light Mini-Pendant  
 Warm Brass w/  
 Bronze Accents  
 4-3/4"W x 7"H  
 Adj H 7" - 42-1/2"  
 1C 60W  
 Clear Glass

**C. 7-9063-1-67**  
 1-Light Pendant  
 Matte Black w/ Polished  
 Chrome Accents  
 12"W x 28-1/2"H  
 Adj H 28-1/2" - 85-1/2"  
 1E 60W  
 Clear Glass

**D. 7-9063-1-95**  
 1-Light Pendant  
 Warm Brass w/  
 Bronze Accents  
 12"W x 28-1/2"H  
 Adj H 28-1/2" - 85-1/2"  
 1E 60W  
 Clear Glass



A.



B.



C.



D.

# AKRON

---



Includes 120' chain & wire.

# AKRON

**A. 7-9006-3-89**

3-Light Pendant  
Matte Black Finish  
12"W x 24"H  
3C 60W  
Clear Glass  
Metal Candle Covers

**B. 7-9006-3-SN**

3-Light Pendant  
Satin Nickel Finish  
12"W x 24"H  
3C 60W  
Clear Glass  
Metal Candle Covers

**C. 7-9006-3-322**

3-Light Pendant  
Warm Brass Finish  
12"W x 24"H  
3C 60W  
Clear Glass  
Metal Candle Covers

**D. 7-9006-3-13**

3-Light Pendant  
English Bronze Finish  
12"W x 24"H  
3C 60W  
Clear Glass  
Metal Candle Covers

# DRAKE



**A. 7-9132-1-109**  
1-Light Pendant  
Polished Nickel Finish  
10"W x 10-1/4"H  
Adj H 10-1/4" - 43"  
1E 60W  
Clear Glass

**B. 7-9132-1-89**  
1-Light Pendant  
Matte Black Finish  
10"W x 10-1/4"H  
Adj H 10-1/4" - 43"  
1E 60W  
Clear Glass

**C. 7-9132-1-322**  
1-Light Pendant  
Warm Brass Finish  
10"W x 10-1/4"H  
Adj H 10-1/4" - 43"  
1E 60W  
Clear Glass

**D. 7-9132-1-13**  
1-Light Pendant  
English Bronze Finish  
10"W x 10-1/4"H  
Adj H 10-1/4" - 43"  
1E 60W  
Clear Glass

**E. 7-9132-1-SN**  
1-Light Pendant  
Satin Nickel Finish  
10"W x 10-1/4"H  
Adj H 10-1/4" - 43"  
1E 60W  
Clear Glass



# DRAKE



Includes 9-1/2" extensions - additional stems available - 7-EXT

# CHANTILLY



**A. 7-1742-1-322**  
 1-Light Pendant  
 Warm Brass Finish  
 8"W x 13"H  
 Adj H 13" - 41-1/2"  
 1E 60W  
 Clear Ribbed Glass

**B. 7-1742-1-89**  
 1-Light Pendant  
 Matte Black Finish  
 8"W x 13"H  
 Adj H 13" - 41-1/2"  
 1E 60W  
 Clear Ribbed Glass

**C. 7-1742-1-109**  
 1-Light Pendant  
 Polished Nickel Finish  
 8"W x 13"H  
 Adj H 13" - 41-1/2"  
 1E 60W  
 Clear Ribbed Glass

Includes 9-1/2" extensions - additional stems available - **7-EXT**



# LAKEWOOD



D.



Dual Mount Hanging System



E.



**D. 7-1831-1-322**

1-Light Pendant  
 Warm Brass Finish  
 8"W x 22"H  
 Adj H 22" - 50-1/2"  
 1E 60W  
 Clear Glass

**E. 7-1831-1-89**

1-Light Pendant  
 Matte Black Finish  
 8"W x 22"H  
 Adj H 22" - 50-1/2"  
 1E 60W  
 Clear Glass

# PENDLETON



\*Includes 9-1/2" extensions - additional stems available - 7-EXT

178 SAVOYHOUSE.COM | 800 801 1621

# PENDLETON



<b>A. 6-7200-1-89</b>	<b>B. 6-7200-1-322</b>	<b>C. 6-7200-1-SN</b>	<b>D. 7-7201-1-89</b>	<b>E. 7-7201-1-322</b>	<b>F. 7-7201-1-SN</b>
1-Light Semi-Flush	1-Light Semi-Flush	1-Light Semi-Flush	1-Light Pendant	1-Light Pendant	1-Light Pendant
Matte Black Finish	Warm Brass Finish	Satin Nickel Finish	Matte Black Finish	Warm Brass Finish	Satin Nickel Finish
9-3/8"W x 9-3/4"H	9-3/8"W x 9-3/4"H	9-3/8"W x 9-3/4"H	14"W x 14"H	14"W x 14"H	14"W x 14"H
1E 60W	1E 60W	1E 60W	Adj H 14'- 45-1/2"	Adj H 14'- 45-1/2"	Adj H 14'- 45-1/2"
Clear Glass	Clear Glass	Clear Glass	1E 60W	1E 60W	1E 60W
			Clear Glass	Clear Glass	Clear Glass

# WRIGHT / CARLTON



\*Includes 12" & 6" extensions - additional stems available - **7-EXT**

\*\*Includes 9-1/2" extensions - additional stems available - **7-EXT**

---

180 SAVOYHOUSE.COM | 800 801 1621

# WRIGHT / CARLTON



Dual Mount Hanging System

**A. CARLTON**  
**7-3390-1-322**  
 1-Light Pendant  
 Warm Brass Finish  
 11"W x 20"H  
 Adj H 20" - 74"  
 1E 60W  
 Ribbed Glass

**B. CARLTON**  
**7-3390-1-89**  
 1-Light Pendant  
 Matte Black Finish  
 11"W x 20"H  
 Adj H 20" - 74"  
 1E 60W  
 Ribbed Glass



**C. WRIGHT**  
**7-3075-1-89**  
 1-Light Mini-Pendant  
 Matte Black Finish  
 5-3/4"W x 9-3/4"H  
 Adj H 9-3/4" - 38-1/4"  
 1E 60W  
 Clear Glass

**D. WRIGHT**  
**7-3075-1-11**  
 1-Light Mini-Pendant  
 Polished Chrome Finish  
 5-3/4"W x 9-3/4"H  
 Adj H 9-3/4" - 38-1/4"  
 1E 60W  
 Clear Glass

**E. WRIGHT**  
**7-3075-1-322**  
 1-Light Mini-Pendant  
 Warm Brass Finish  
 5-3/4"W x 9-3/4"H  
 Adj H 9-3/4" - 38-1/4"  
 1E 60W  
 Clear Glass



# CALHOUN



Includes 9-1/2" extensions - additional stems available - **7-EXT**

182 SAVOYHOUSE.COM | 800 801 1621



# CALHOUN



Dual Mount Hanging System

**A. 7-1026-1-SN**  
1-Light Mini-Pendant  
Satin Nickel Finish  
5"W x 7"H  
Adj H 7" - 37"  
IE 60W  
Clear Glass

**B. 7-1026-1-B9**  
1-Light Mini-Pendant  
Matte Black Finish  
5"W x 7"H  
Adj H 7" - 37"  
IE 60W  
Clear Glass

**C. 7-1026-1-322**  
1-Light Mini-Pendant  
Warm Brass Finish  
5"W x 7"H  
Adj H 7" - 37"  
IE 60W  
Clear Glass

**D. 7-1027-1-SN**  
1-Light Pendant  
Satin Nickel Finish  
8"W x 11"H  
Adj H 11" - 63"  
IE 60W  
Clear Glass

**E. 7-1027-1-B9**  
1-Light Pendant  
Matte Black Finish  
8"W x 11"H  
Adj H 11" - 63"  
IE 60W  
Clear Glass

**F. 7-1027-1-322**  
1-Light Pendant  
Warm Brass Finish  
8"W x 11"H  
Adj H 11" - 63"  
IE 60W  
Clear Glass

A.



B.



C.

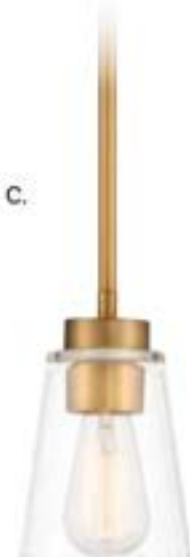

D.



E.



F.



# ASHMONT



**A. 7-130-1-63**  
1-Light Pendant  
Warm Brass Lustré Finish  
13"W x 21-1/4"H  
Adj H 21-1/4" - 49-3/4"  
1E 60W  
White Opal Glass



**B. 7-130-1-SN**  
1-Light Pendant  
Satin Nickel Finish  
13"W x 21-1/4"H  
Adj H 21-1/4" - 49-3/4"  
1E 60W  
White Opal Glass



**C. 7-130-1-44**  
1-Light Pendant  
Classic Bronze Finish  
13"W x 21-1/4"H  
Adj H 21-1/4" - 49-3/4"  
1E 60W  
White Opal Glass

Includes 9-1/2" extensions - additional stems available - **7-EXT**

# PENDANTS



**D. HERNDON**  
 7-1010-1-SN  
 1-Light Mini-Pendant  
 Satin Nickel Finish  
 5-1/2"W x 9-1/2"H  
 Adj H 9-1/2" - 38"  
 1E 60W  
 Frosted White Glass



**E. VINTAGE**  
 7-4134-1-13  
 1-Light Mini-Pendant  
 English Bronze Finish  
 7"W x 10-1/2"H  
 Adj H 10-1/2" - 42"  
 1E 60W  
 Clear Glass



**F. VINTAGE**  
 7-4134-1-SN  
 1-Light Mini-Pendant  
 Satin Nickel Finish  
 7"W x 10-1/2"H  
 Adj H 10-1/2" - 42"  
 1E 60W  
 Clear Glass



**G. CHIVAL**  
 7-730-1-109  
 1-Light Pendant  
 Polished Nickel Finish  
 11"W x 17"H  
 Adj H 17" - 48-1/2"  
 1E 60W  
 White Opal Etched Glass

# FRANKLIN/BALLY



**A. FRANKLIN**  
**7-702-1-13**  
 1-Light Pendant  
 English Bronze Finish  
 10"W x 20"H  
 1E 60W  
 Clear Glass

**B. FRANKLIN**  
**7-703-1-SN**  
 1-Light Pendant  
 Satin Nickel Finish  
 10"W x 20"H  
 1E 60W  
 Silver Mercury Glass

**C. FRANKLIN**  
**7-702-1-109**  
 1-Light Pendant  
 Polished Nickel Finish  
 10"W x 20"H  
 1E 60W  
 Clear Glass

**D. BALLY**  
**7-700-1-109**  
 1-Light Pendant  
 Polished Nickel Finish  
 6-1/2"W x 12"H  
 1E 60W  
 Clear Glass

**E. BALLY**  
**7-701-1-SN**  
 1-Light Pendant  
 Satin Nickel Finish  
 6-1/2"W x 12"H  
 1E 60W  
 Silver Mercury Glass

Includes 120" chain & wire.

# OCTAVE

**F. 7-4036-1-SN**

1-Light Pendant  
Satin Nickel Finish  
8"W x 10-1/2"H  
Adj H 10-1/2" - 42"  
1E 60W  
Clear Glass

**G. 7-4036-1-BK**

1-Light Pendant  
Matte Black Finish  
8"W x 10-1/2"H  
Adj H 10-1/2" - 42"  
1E 60W  
Clear Glass

**H. 7-4036-1-11**

1-Light Pendant  
Polished Chrome Finish  
8"W x 10-1/2"H  
Adj H 10-1/2" - 42"  
1E 60W  
Clear Glass

**I. 7-4036-1-322**

1-Light Pendant  
Warm Brass Finish  
8"W x 10-1/2"H  
Adj H 10-1/2" - 42"  
1E 60W  
Clear Glass

**J. 7-4036-1-13**

1-Light Pendant  
English Bronze Finish  
8"W x 10-1/2"H  
Adj H 10-1/2" - 42"  
1E 60W  
Clear Glass

Includes 9-1/2" extensions - additional stems available - **7-EXT**

# REID



**A. 6-1953-4-322**  
 4-Light Ceiling Light  
 Warm Brass Finish  
 20"W x 13-1/2"H  
 4E 60W  
 White Fabric Shade

**B. 6-1953-4-89**  
 4-Light Ceiling Light  
 Matte Black Finish  
 20"W x 13-1/2"H  
 4E 60W  
 White Fabric Shade

**C. 6-1953-4-109**  
 4-Light Ceiling Light  
 Polished Nickel Finish  
 20"W x 13-1/2"H  
 4E 60W  
 White Fabric Shade

# REID



# MARCO





# MARCO



**A. 6-1950-6-322**  
6-Light Semi-Flush  
Warm Brass Finish  
24"W x 18-1/4"H  
6C 60W  
White Opal Glass

**B. 6-1951-6-322**  
6-Light Semi-Flush  
Warm Brass Finish  
24"W x 18-1/4"H  
6C 60W  
Clear Glass

**C. 6-1950-6-89**  
6-Light Semi-Flush  
Matte Black Finish  
24"W x 18-1/4"H  
6C 60W  
White Opal Glass



# STOCKTON



# STOCKTON

A.



B.



**A. 6-1679-5-SN**  
5-Light Semi-Flush  
Satin Nickel Finish  
24"W x 12"H  
5C 60W

**B. 6-1679-5-322**  
5-Light Semi-Flush  
Warm Brass Finish  
24"W x 12"H  
5C 60W

**C. 6-1679-5-89**  
5-Light Semi-Flush  
Matte Black Finish  
24"W x 12"H  
5C 60W

C.



# LYRIQUE

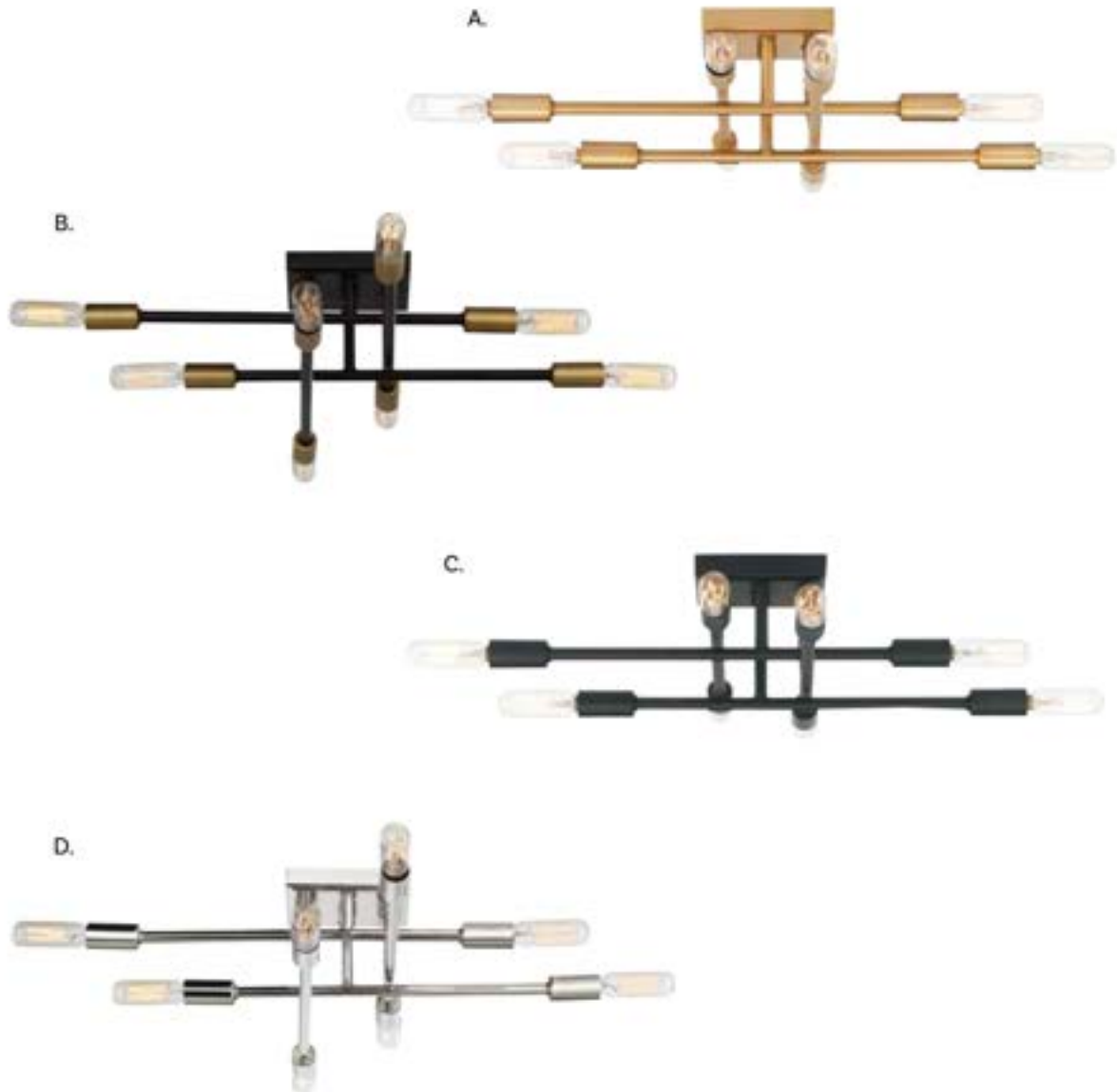

# LYRIQUE

**A. 6-7003-8-322**

8-Light Flush Mount  
Warm Brass Finish  
19-1/2"L x 19-1/2"W x 4-3/4"H  
8C 60W

**B. 6-7003-8-77**

8-Light Flush Mount  
Bronze w/ Brass Accents  
19-1/2"L x 19-1/2"W x 4-3/4"H  
8C 60W

**C. 6-7003-8-89**

8-Light Flush Mount  
Matte Black Finish  
19-1/2"L x 19-1/2"W x 4-3/4"H  
8C 60W

**D. 6-7003-8-109**

8-Light Flush Mount  
Polished Nickel Finish  
19-1/2"L x 19-1/2"W x 4-3/4"H  
8C 60W

# WATKINS



- A. 6-134-3-322**  
3-Light Semi-Flush  
Warm Brass Finish  
16"W x 9-1/4"H  
3E 60W  
White Opal Glass
- B. 6-134-3-44**  
3-Light Semi-Flush  
Classic Bronze Finish  
16"W x 9-1/4"H  
3E 60W  
White Opal Glass
- C. 6-134-3-109**  
3-Light Semi-Flush  
Polished Nickel Finish  
16"W x 9-1/4"H  
3E 60W  
White Opal Glass
- D. 6-133-16-322**  
3-Light Flush Mount  
Warm Brass Finish  
16"W x 4"H  
3E 60W  
White Opal Glass
- E. 6-133-16-44**  
3-Light Flush Mount  
Classic Bronze Finish  
16"W x 4"H  
3E 60W  
White Opal Glass
- F. 6-133-16-109**  
3-Light Flush Mount  
Polished Nickel Finish  
16"W x 4"H  
3E 60W  
White Opal Glass

# WATKINS

---



# LUCERNE



A.



B.



C.



D.



E.



F.



G.



H.

**A. 6-3350-16-109**  
 3-Light Flush Mount  
 Polished Nickel Finish  
 15"W x 4-3/4"H  
 3E 60W  
 White Glass

**B. 6-3350-14-109**  
 2-Light Flush Mount  
 Polished Nickel Finish  
 13-1/4"W x 4-3/4"H  
 2E 60W  
 White Glass

**C. 6-3350-16-13**  
 3-Light Flush Mount  
 English Bronze Finish  
 15"W x 4-3/4"H  
 3E 60W  
 White Glass

**D. 6-3350-14-13**  
 2-Light Flush Mount  
 English Bronze Finish  
 13-1/4"W x 4-3/4"H  
 2E 60W  
 White Glass



# LUCERNE



**E. 6-3350-16-322**  
 3-Light Flush Mount  
 Warm Brass Finish  
 15"W x 4-3/4"H  
 3E 60W  
 White Glass

**F. 6-3350-14-322**  
 2-Light Flush Mount  
 Warm Brass Finish  
 13-1/4"W x 4-3/4"H  
 2E 60W  
 White Glass

**G. 6-3350-16-SN**  
 3-Light Flush Mount  
 Satin Nickel Finish  
 15"W x 4-3/4"H  
 3E 60W  
 White Glass

**H. 6-3350-14-SN**  
 2-Light Flush Mount  
 Satin Nickel Finish  
 13-1/4"W x 4-3/4"H  
 2E 60W  
 White Glass

# OCTAVE



**A. 6-4037-1-SN**  
1-Light Semi-Flush  
Satin Nickel Finish  
6"W x 13-1/2"H  
1E 60W  
Clear Glass



**B. 6-4037-1-BK**  
1-Light Semi-Flush  
Matte Black Finish  
6"W x 13-1/2"H  
1E 60W  
Clear Glass



**C. 6-4037-1-11**  
1-Light Semi-Flush  
Polished Chrome Finish  
6"W x 13-1/2"H  
1E 60W  
Clear Glass

**D. 6-4037-1-322**  
1-Light Semi-Flush  
Warm Brass Finish  
6"W x 13-1/2"H  
1E 60W  
Clear Glass

**E. 6-4037-1-13**  
1-Light Semi-Flush  
English Bronze Finish  
6"W x 13-1/2"H  
1E 60W  
Clear Glass



# OCTAVE



**F. 6-4035-3-SN**  
3-Light Semi-Flush  
Satin Nickel Finish  
13"W x 11"H  
3E 60W  
Clear Glass

**G. 6-4035-3-BK**  
3-Light Semi-Flush  
Matte Black Finish  
13"W x 11"H  
3E 60W  
Clear Glass

**H. 6-4035-3-11**  
3-Light Semi-Flush  
Polished Chrome  
Finish  
13"W x 11"H  
3E 60W  
Clear Glass

**I. 6-4035-3-13**  
3-Light Semi-Flush  
English Bronze Finish  
13"W x 11"H  
3E 60W  
Clear Glass

**J. 6-4035-3-322**  
3-Light Semi-Flush  
Warm Brass Finish  
13"W x 11"H  
3E 60W  
Clear Glass



# AVALON



# AVALON



**A. 6-7790-3-322**  
3-Light Semi-Flush  
Warm Brass Finish  
11-3/8"W x 12-1/4"H  
3C 60W  
Crackled Glass  
Metal Candle Covers

**B. 6-7790-3-SN**  
3-Light Semi-Flush  
Satin Nickel Finish  
11-3/8"W x 12-1/4"H  
3C 60W  
Crackled Glass  
Metal Candle Covers

**C. 6-7790-3-89**  
3-Light Semi-Flush  
Matte Black Finish  
11-3/8"W x 12-1/4"H  
3C 60W  
Crackled Glass  
Metal Candle Covers

# KENT



A.

**A. 6-4900-4-89**  
4-Light Semi-Flush  
Matte Black Finish  
16"W x 14-3/4"H  
4E 60W  
Metal Candle Covers



B.

**B. 6-4900-4-322**  
4-Light Semi-Flush  
Warm Brass Finish  
16"W x 14-3/4"H  
4E 60W  
Metal Candle Covers



C.

**C. 6-4900-4-SN**  
4-Light Semi-Flush  
Satin Nickel Finish  
16"W x 14-3/4"H  
4E 60W  
Metal Candle Covers

# BENSON



D.

**D. 6-7702-3-89**  
 3-Light Semi-Flush  
 Matte Black Finish  
 13"W x 12"H  
 3C 60W  
 Metal Candle Covers



E.

**E. 6-7702-3-322**  
 3-Light Semi-Flush  
 Warm Brass Finish  
 13"W x 12"H  
 3C 60W  
 Metal Candle Covers



F.

**F. 6-7702-3-SN**  
 3-Light Semi-Flush  
 Satin Nickel Finish  
 13"W x 12"H  
 3C 60W  
 Metal Candle Covers



Pendant, Page 129

# CALHOUN / PENROSE



- |                     |                     |                    |                        |                       |                     |
|---------------------|---------------------|--------------------|------------------------|-----------------------|---------------------|
| <b>A. CALHOUN</b>   | <b>B. CALHOUN</b>   | <b>C. CALHOUN</b>  | <b>D. PENROSE</b>      | <b>E. PENROSE</b>     | <b>F. PENROSE</b>   |
| <b>6-1024-3-SN</b>  | <b>6-1024-3-322</b> | <b>6-1024-3-89</b> | <b>6-1043-3-109</b>    | <b>6-1043-3-13</b>    | <b>6-1043-3-SN</b>  |
| 3-Light Semi-Flush  | 3-Light Semi-Flush  | 3-Light Semi-Flush | 3-Light Semi-Flush     | 3-Light Semi-Flush    | 3-Light Semi-Flush  |
| Satin Nickel Finish | Warm Brass Finish   | Matte Black Finish | Polished Nickel Finish | English Bronze Finish | Satin Nickel Finish |
| 13"W x 11-1/2"H     | 13"W x 11-1/2"H     | 13"W x 11-1/2"H    | 12-1/2"W x 14"H        | 12-1/2"W x 14"H       | 12-1/2"W x 14"H     |
| 3E 60W              | 3E 60W              | 3E 60W             | 3C 60W                 | 3C 60W                | 3C 60W              |
| Clear Glass         | Clear Glass         | Clear Glass        | Clear Glass            | Clear Glass           | Clear Glass         |
|                     |                     |                    | Metal Candle Covers    | Metal Candle Covers   | Metal Candle Covers |



# PENDLETON / BERG

**G. PENDLETON****6-7200-1-322**

1-Light Semi-Flush  
Warm Brass Finish  
9-3/8"W x 9-3/4"H  
1E 60W  
Clear Glass

**H. PENDLETON****6-7200-1-SN**

1-Light Semi-Flush  
Satin Nickel Finish  
9-3/8"W x 9-3/4"H  
1E 60W  
Clear Glass

**I. PENDLETON****6-7200-1-89**

1-Light Semi-Flush  
Matte Black Finish  
9-3/8"W x 9-3/4"H  
1E 60W  
Clear Glass

**J. BERG****6-3750-1-322**

1-Light Semi-Flush  
Warm Brass Finish  
12"W x 12"H  
1E 60W

**K. BERG****6-3750-1-89**

1-Light Semi-Flush  
Matte Black Finish  
12"W x 12"H  
1E 60W

# CEILING



A.

**A. MELROSE**  
**6-6835-2-13**  
2-Light Semi-Flush  
English Bronze Finish  
14"W x 11-1/2"H  
2E 60W  
White Opal Etched Glass



B.

**B. MELROSE**  
**6-6835-2-SN**  
2-Light Semi-Flush  
Satin Nickel Finish  
14"W x 11-1/2"H  
2E 60W  
White Opal Etched Glass

# CEILING



C.



D.



E.



F.



G.



H.



I.



J.

**C. 6-780-13-BK**  
2-Light Flush Mount  
Matte Black Finish  
13"W x 5"H  
2E 60W  
White Etched Glass

**D. 6-780-11-BK**  
2-Light Flush Mount  
Matte Black Finish  
11"W x 4-1/2"H  
2E 40W  
White Etched Glass

**E. 6-780-13-SN**  
2-Light Flush Mount  
Satin Nickel Finish  
13"W x 5"H  
2E 60W  
White Etched Glass

**F. 6-780-11-SN**  
2-Light Flush Mount  
Satin Nickel Finish  
11"W x 4-1/2"H  
2E 40W  
White Etched Glass

**G. 6-780-13-322**  
2-Light Flush Mount  
Warm Brass Finish  
13"W x 5"H  
2E 60W  
White Etched Glass

**H. 6-780-11-322**  
2-Light Flush Mount  
Warm Brass Finish  
11"W x 4-1/2"H  
2E 40W  
White Etched Glass

**I. 6-780-13-13**  
2-Light Flush Mount  
English Bronze Finish  
13"W x 5"H  
2E 60W  
White Etched Glass

**J. 6-780-11-13**  
2-Light Flush Mount  
English Bronze Finish  
11"W x 4-1/2"H  
2E 40W  
White Etched Glass

# COMO



# COMO



A.

**A. 9-6520-1-89**  
LED Sconce  
Matte Black Finish  
11"W x 20"H x 4"E  
14W Dimmable LED  
300 Lumens, 3000K, 90+ CRI



B.

**B. 9-6520-1-109**  
LED Sconce  
Polished Nickel Finish  
11"W x 20"H x 4"E  
14W Dimmable LED  
300 Lumens, 3000K, 90+ CRI

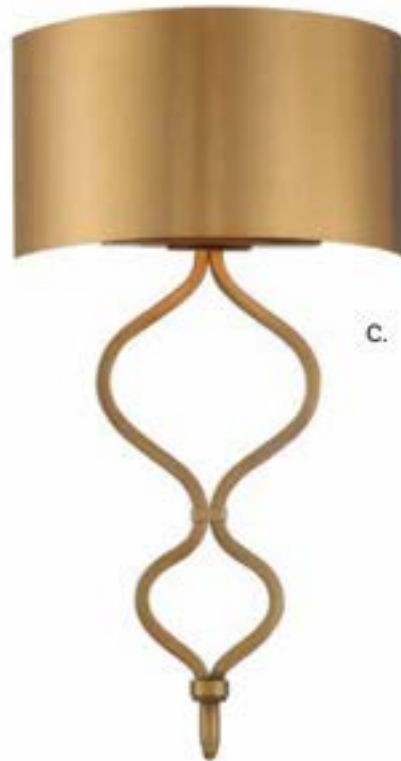

C.

**C. 9-6520-1-322**  
LED Sconce  
Warm Brass Finish  
11"W x 20"H x 4"E  
14W Dimmable LED  
300 Lumens, 3000K, 90+ CRI



# JOFFREE



**A. 9-1914-1-322**  
1-Light Sconce  
Warm Brass Finish  
5"W x 20-3/8"H x 6-1/2"E  
1C 60W  
White Fabric Shade

**B. 9-1914-1-89**  
1-Light Sconce  
Matte Black Finish  
5"W x 20-3/8"H x 6-1/2"E  
1C 60W  
White Fabric Shade



A.



B.

# POLSON



**C. 9-1911-1-322**  
 1-Light Sconce  
 Warm Brass Finish  
 8"W x 15-1/2"H x 8"E  
 1E 60W  
 Opal Etched Glass

**D. 9-1911-1-89**  
 1-Light Sconce  
 Matte Black Finish  
 8"W x 15-1/2"H x 8"E  
 1E 60W  
 Opal Etched Glass

**E. 9-1911-1-11**  
 1-Light Sconce  
 Polished Chrome Finish  
 8"W x 15-1/2"H x 8"E  
 1E 60W  
 Opal Etched Glass

# RHODES



- |                      |                       |                        |                      |                       |
|----------------------|-----------------------|------------------------|----------------------|-----------------------|
| <b>A. 9-998-2-SN</b> | <b>B. 9-998-2-44</b>  | <b>C. 9-998-2-109</b>  | <b>D. 9-998-2-89</b> | <b>E. 9-998-2-322</b> |
| 2-Light Sconce       | 2-Light Sconce        | 2-Light Sconce         | 2-Light Sconce       | 2-Light Sconce        |
| Satin Nickel Finish  | Classic Bronze Finish | Polished Nickel Finish | Matte Black Finish   | Warm Brass Finish     |
| 14"W x 12"H x 4"E    | 14"W x 12"H x 4"E     | 14"W x 12"H x 4"E      | 14"W x 12"H x 4"E    | 14"W x 12"H x 4"E     |
| 2C 60W               | 2C 60W                | 2C 60W                 | 2C 60W               | 2C 60W                |
| White Linen Shade    | White Linen Shade     | White Linen Shade      | White Linen Shade    | White Linen Shade     |
| Metal Candle Covers  | Metal Candle Covers   | Metal Candle Covers    | Metal Candle Covers  | Metal Candle Covers   |



# RHODES



# JEFFERSON



# JEFFERSON



- |                       |                       |                        |                       |                       |                        |
|-----------------------|-----------------------|------------------------|-----------------------|-----------------------|------------------------|
| <b>A. 9-5201-1-83</b> | <b>B. 9-5201-1-89</b> | <b>C. 9-5201-1-322</b> | <b>D. 9-5202-2-83</b> | <b>E. 9-5202-2-89</b> | <b>F. 9-5202-2-322</b> |
| 1-Light Sconce        | 1-Light Sconce        | 1-Light Sconce         | 2-Light Sconce        | 2-Light Sconce        | 2-Light Sconce         |
| Bisque White Finish   | Matte Black Finish    | Warm Brass Finish      | Bisque White Finish   | Matte Black Finish    | Warm Brass Finish      |
| 5-1/2"W x 20"H x 7"E  | 5-1/2"W x 20"H x 7"E  | 5-1/2"W x 20"H x 7"E   | 16"W x 20"H x 7"E     | 16"W x 20"H x 7"E     | 16"W x 20"H x 7"E      |
| 1C 60W                | 1C 60W                | 1C 60W                 | 2C 60W                | 2C 60W                | 2C 60W                 |
| Metal Shade           | Metal Shade           | Metal Shade            | Metal Shade           | Metal Shade           | Metal Shade            |

# FREMONT



A.



B.

**A. 9-103-2-SN**

2-Light Sconce  
Satin Nickel Finish  
13"W x 21"H x 6-1/4"E  
2C 60W  
Soft White Shade  
Metal Candle Covers

**B. 9-101-1-SN**

1-Light Sconce  
Satin Nickel Finish  
5"W x 21"H x 7"E  
1C 60W  
Soft White Shade  
Metal Candle Cover

**C. 9-103-2-322**

2-Light Sconce  
Warm Brass Finish  
13"W x 21"H x 6-1/4"E  
2C 60W  
Soft White Shades  
Metal Candle Cover

**D. 9-101-1-B9**

1-Light Sconce  
Matte Black Finish  
5"W x 21"H x 7"E  
1C 60W  
Soft White Shade  
Metal Candle Cover

# FREMONT



C.



D.



E.



F.



G.



H.

**E. 9-103-2-109**  
2-Light Sconce  
Polished Nickel Finish  
13"W x 21"H x 6-1/4"E  
2C 60W  
Soft White Shades  
Metal Candle Cover

**F. 9-101-1-322**  
1-Light Sconce  
Warm Brass Finish  
5"W x 21"H x 7"E  
1C 60W  
Soft White Shade  
Metal Candle Cover

**G. 9-103-2-89**  
2-Light Sconce  
Matte Black Finish  
13"W x 21"H x 6-1/4"E  
2C 60W  
Soft White Shades  
Metal Candle Cover

**H. 9-101-1-109**  
1-Light Sconce  
Polished Nickel Finish  
5"W x 21"H x 7"E  
1C 60W  
Soft White Shade  
Metal Candle Cover

# MONROE



# MONROE

**A. 9-302-1-SN**

1-Light Sconce  
Satin Nickel Finish  
5"W x 20"H x 6"E  
1C 60W  
White Fabric Shade  
Metal Candle Cover



**B. 9-303-1-SN**

1-Light Sconce  
Satin Nickel Finish  
5"W x 24"H x 6-1/2"E  
1C 60W  
White Fabric Shade  
Metal Candle Cover

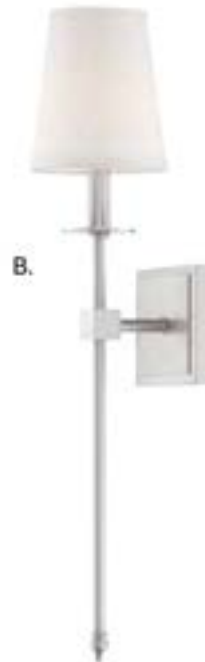

**C. 9-7144-1-SN**

1-Light Sconce  
Satin Nickel Finish  
6-3/4"W x 33-1/2"H x 8"E  
1C 60W  
White Fabric Shade  
Metal Candle Cover

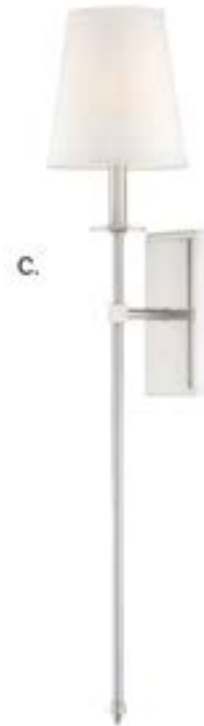

**D. 9-7144-1-89**

1-Light Sconce  
Matte Black Finish  
6-3/4"W x 33-1/2"H x 8"E  
1C 60W  
White Fabric Shade  
Metal Candle Cover



**E. 9-303-1-89**

1-Light Sconce  
Matte Black Finish  
5"W x 24"H x 6-1/2"E  
1C 60W  
White Fabric Shade  
Metal Candle Cover



**F. 9-302-1-89**

1-Light Sconce  
Matte Black Finish  
5"W x 20"H x 6"E  
1C 60W  
White Fabric Shade  
Metal Candle Cover



# MONROE



A.



B.



C.

**A. 9-7144-1-322**  
1-Light Sconce  
Warm Brass Finish  
6-3/4\"W x 33-1/2\"H x 8\"E  
1C 60W  
White Fabric Shade  
Metal Candle Cover

**B. 9-303-1-322**  
1-Light Sconce  
Warm Brass Finish  
5\"W x 24\"H x 6-1/2\"E  
1C 60W  
White Fabric Shade  
Metal Candle Cover

**C. 9-302-1-322**  
1-Light Sconce  
Warm Brass Finish  
5\"W x 20\"H x 6\"E  
1C 60W  
White Fabric Shade  
Metal Candle Cover

**D. 9-302-1-44**  
1-Light Sconce  
Classic Bronze Finish  
5\"W x 20\"H x 6\"E  
1C 60W  
White Fabric Shade  
Metal Candle Cover

**E. 9-303-1-44**  
1-Light Sconce  
Classic Bronze Finish  
5\"W x 24\"H x 6-1/2\"E  
1C 60W  
White Fabric Shade  
Metal Candle Cover

**F. 9-7144-1-44**  
1-Light Sconce  
Classic Bronze Finish  
6-3/4\"W x 33-1/2\"H x 8\"E  
1C 60W  
White Fabric Shade  
Metal Candle Cover



D.



E.



F.



# MONROE



**G. 9-7144-1-109**

1-Light Sconce  
Polished Nickel Finish  
6-3/4"W x 33-1/2"H x 8"E  
1C 60W  
White Fabric Shade  
Metal Candle Cover

**H. 9-303-1-109**

1-Light Sconce  
Polished Nickel Finish  
5"W x 24"H x 6-1/2"E  
1C 60W  
White Fabric Shade  
Metal Candle Cover

**I. 9-302-1-109**

1-Light Sconce  
Polished Nickel Finish  
5"W x 20"H x 6"E  
1C 60W  
White Fabric Shade  
Metal Candle Cover



# CAMERON



**A. 9-2542-1-322**  
 1-Light Sconce  
 Warm Brass Finish  
 5"W x 13"H x 8"E  
 1C 40W  
 White Fabric Shade  
 Metal Candle Cover

**B. 9-2542-1-89**  
 1-Light Sconce  
 Matte Black Finish  
 5"W x 13"H x 8"E  
 1C 40W  
 White Fabric Shade  
 Metal Candle Cover

**C. 9-2542-1-109**  
 1-Light Sconce  
 Polished Nickel Finish  
 5"W x 13"H x 8"E  
 1C 40W  
 White Fabric Shade  
 Metal Candle Cover



# WASHBURN



**D. 9-0700-1-322**  
 1-Light Sconce  
 Warm Brass Finish  
 7"W x 15"H x 9"E  
 1C 60W  
 White Fabric Shade  
 Metal Candle Cover

**E. 9-0700-1-5N**  
 1-Light Sconce  
 Satin Nickel Finish  
 7"W x 15"H x 9"E  
 1C 60W  
 White Fabric Shade  
 Metal Candle Cover

**F. 9-0700-1-109**  
 1-Light Sconce  
 Polished Nickel Finish  
 7"W x 15"H x 9"E  
 1C 60W  
 White Fabric Shade  
 Metal Candle Cover

# DESTIN



**A. 9-0902-1-322**  
 1-Light Sconce  
 Warm Brass Finish  
 6"W x 25"H x 6-7/8"E  
 1C 60W  
 White Opal Glass

**B. 9-0902-1-89**  
 1-Light Sconce  
 Matte Black Finish  
 6"W x 25"H x 6-7/8"E  
 1C 60W  
 White Opal Glass

**C. 9-0902-1-109**  
 1-Light Sconce  
 Polished Nickel Finish  
 6"W x 25"H x 6-7/8"E  
 1C 60W  
 White Opal Glass

# DEVON



**D. 9-7140-1-322**  
1-Light Sconce  
Warm Brass Finish  
7-1/2"W x 26-1/2"H x 5-1/2"E  
1C 60W  
White Fabric Shade  
Metal Candle Cover

**E. 9-7140-1-5N**  
1-Light Sconce  
Satin Nickel Finish  
7-1/2"W x 26-1/2"H x 5-1/2"E  
1C 60W  
White Fabric Shade  
Metal Candle Cover

# POWELL



# POWELL



**A. 9-1755-1-89**  
1-Light Sconce  
Matte Black Finish  
5"W x 15"H x 5-1/2"E  
1C 60W  
White Fabric Shade

**B. 9-1755-1-322**  
1-Light Sconce  
Warm Brass Finish  
5"W x 15"H x 5-1/2"E  
1C 60W  
White Fabric Shade

**C. 9-1755-1-109**  
1-Light Sconce  
Polished Nickel Finish  
5"W x 15"H x 5-1/2"E  
1C 60W  
White Fabric Shade



Chandelier, Page 86

# WILLMAR

**A. 9-996-1-89**

1-Light Sconce  
Matte Black Finish  
4-1/2"W x 16"H x 3-3/4"E  
1E 60W  
Clear Reeded Glass  
**300mm T10 Bulb Included**

**B. 9-996-1-SN**

1-Light Sconce  
Satin Nickel Finish  
4-1/2"W x 16"H x 3-3/4"E  
1E 60W  
Clear Reeded Glass  
**300mm T10 Bulb Included**

**C. 9-996-1-109**

1-Light Sconce  
Polished Nickel Finish  
4-1/2"W x 16"H x 3-3/4"E  
1E 60W  
Clear Reeded Glass  
**300mm T10 Bulb Included**

**D. 9-996-1-322**

1-Light Sconce  
Warm Brass Finish  
4-1/2"W x 16"H x 3-3/4"E  
1E 60W  
Clear Reeded Glass  
**300mm T10 Bulb Included**



# WILLMAR

---



# PIKE



A.



B.



C.

- A. 9-16000-1-322**  
 1-Light Sconce  
 Warm Brass Finish  
 4-1/2"W x 17-3/4"H x 6-1/2"E  
 1E 60W  
 Clear Ribbed Glass  
 300MM T9 Bulb Included
- B. 9-16000-1-109**  
 1-Light Sconce  
 Polished Nickel Finish  
 4-1/2"W x 17-3/4"H x 6-1/2"E  
 1E 60W  
 Clear Ribbed Glass  
 300MM T9 Bulb Included
- C. 9-16000-1-44**  
 1-Light Sconce  
 Classic Bronze Finish  
 4-1/2"W x 17-3/4"H x 6-1/2"E  
 1E 60W  
 Clear Ribbed Glass  
 300MM T9 Bulb Included



# CLIFTON



D.



E.



F.

**D. 9-900-1-109**  
1-Light Sconce  
Polished Nickel Finish  
4-1/2"W x 15-1/4"H x 4-1/2"E  
1E 60W  
300MM T9 Bulb Included

**E. 9-900-1-322**  
1-Light Sconce  
Warm Brass Finish  
4-1/2"W x 15-1/4"H x 4-1/2"E  
1E 60W  
300MM T9 Bulb Included

**F. 9-900-1-44**  
1-Light Sconce  
Classic Bronze Finish  
4-1/2"W x 15-1/4"H x 4-1/2"E  
1E 60W  
300MM T9 Bulb Included

# KENYON



**A. 9-1918-1-150**  
1-Light Sconce  
Matte Black w/  
Polished Chrome Accents  
5"W x 16-1/2"H x 4-3/4"E  
1E 60W

**B. 9-1918-1-77**  
1-Light Sconce  
Bronze w/  
Warm Brass Accents  
5"W x 16-1/2"H x 4-3/4"E  
1E 60W

# DAWSON



**C. 9-1916-1-89**  
1-Light Sconce  
Matte Black Finish  
4-3/4"W x 17-7/8"H x 3-1/2"E  
1C 60W



**D. 9-1916-1-322**  
1-Light Sconce  
Warm Brass Finish  
4-3/4"W x 17-7/8"H x 3-1/2"E  
1C 60W



**E. 9-1916-1-11**  
1-Light Sconce  
Polished Chrome Finish  
4-3/4"W x 17-7/8"H x 3-1/2"E  
1C 60W

# FOSTER



**A. 9-7005-1-89**  
1-Light Sconce  
Matte Black Finish  
8"W x 14"H x 10"E  
1E 60W  
Clear Seeded Glass

**B. 9-7005-1-322**  
1-Light Pendant  
Warm Brass Finish  
8"W x 14"H x 10"E  
1E 60W  
Clear Seeded Glass

**C. 9-7005-1-SN**  
1-Light Pendant  
Satin Nickel Finish  
8"W x 14"H x 10"E  
1E 60W  
Clear Seeded Glass

# CRAWFORD



**D. 9-1801-1-322**  
 1-Light Sconce  
 Warm Brass Finish  
 10"W x 17-1/4"H x 9-1/4"E  
 1E 60W  
 Clear Water Glass

**E. 9-1801-1-89**  
 1-Light Sconce  
 Matte Black Finish  
 10"W x 17-1/4"H x 9-1/4"E  
 1E 60W  
 Clear Water Glass

**F. 9-1801-1-SN**  
 1-Light Sconce  
 Satin Nickel Finish  
 10"W x 17-1/4"H x 9-1/4"E  
 1E 60W  
 Clear Water Glass

# GLENN

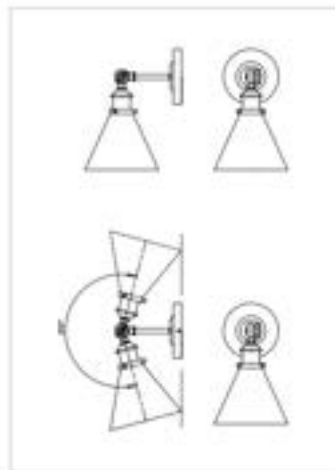

**A. 9-0901-1-SN**  
 1-Light Adjustable  
 Sconce  
 Satin Nickel Finish  
 7"W x 12"H x 9"E  
 1E 60W

**B. 9-0901-1-44**  
 1-Light Adjustable  
 Sconce  
 Classic Bronze Finish  
 7"W x 12"H x 9"E  
 1E 60W

**C. 9-0901-1-109**  
 1-Light Adjustable  
 Sconce  
 Polished Nickel Finish  
 7"W x 12"H x 9"E  
 1E 60W

**D. 9-0901-1-322**  
 1-Light Adjustable  
 Sconce  
 Warm Brass Finish  
 7"W x 12"H x 9"E  
 1E 60W

**E. 9-0901-1-89**  
 1-Light Adjustable  
 Sconce  
 Matte Black Finish  
 7"W x 12"H x 9"E  
 1E 60W



# WAVERLY



F.



G.



H.



L.

**F. 9-1200-1-SN**  
1-Light Sconce  
Satin Nickel Finish  
5"W x 11"H x 6-1/2"E  
1C 60W  
White Fabric Shade  
Metal Candle Cover

**G. 9-1200-1-89**  
1-Light Sconce  
Matte Black Finish  
5"W x 11"H x 6-1/2"E  
1C 60W  
White Fabric Shade  
Metal Candle Cover

**H. 9-1200-1-322**  
1-Light Sconce  
Warm Brass Finish  
5"W x 11"H x 6-1/2"E  
1C 60W  
White Fabric Shade  
Metal Candle Cover

**L. 9-1200-1-109**  
1-Light Sconce  
Polished Nickel Finish  
5"W x 11"H x 6-1/2"E  
1C 60W  
White Fabric Shade  
Metal Candle Cover

# YORK

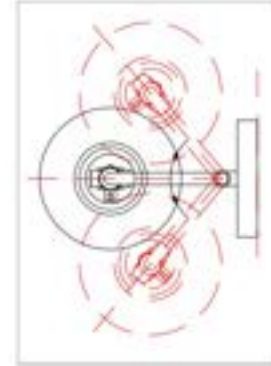

**A. 9-108-1-5N**  
 1-Light Adjustable Sconce  
 Satin Nickel Finish  
 5-1/2"W x 16"H x 8-1/2"E  
 1E 60W  
 100° Swivel  
 Clear Seeded Glass

**B. 9-108-1-89**  
 1-Light Adjustable Sconce  
 Matte Black Finish  
 5-1/2"W x 16"H x 8-1/2"E  
 1E 60W  
 100° Swivel  
 Clear Seeded Glass



**C. 9-108-1-322**  
 1-Light Adjustable Sconce  
 Warm Brass Finish  
 5-1/2"W x 16"H x 8-1/2"E  
 1E 60W  
 100° Swivel  
 Clear Seeded Glass

# YORK



# MORLAND



**A. 9-961CP-1-89**  
1-Light Adjustable  
Sconce  
Matte Black Finish  
6"W x 16"H x 13"E  
Adj E 13" - 33-3/4"  
1E 60W

**B. 9-961CP-1-13**  
1-Light Adjustable  
Sconce  
English Bronze Finish  
6"W x 16"H x 13"E  
Adj E 13" - 33-3/4"  
1E 60W

**C. 9-961CP-1-322**  
1-Light Adjustable  
Sconce  
Warm Brass Finish  
6"W x 16"H x 13"E  
Adj E 13" - 33-3/4"  
1E 60W

**D. 9-961CP-1-109**  
1-Light Adjustable  
Sconce  
Polished Nickel Finish  
6"W x 16"H x 13"E  
Adj E 13" - 33-3/4"  
1E 60W

**E. 9-961CP-1-5N**  
1-Light Adjustable  
Sconce  
Satin Nickel Finish  
6"W x 16"H x 13"E  
Adj E 13" - 33-3/4"  
1E 60W

Includes cord, plug, and hardwire hardware

## OWEN

**F. 9-0900CP-1-322**

1-Light Adjustable  
Sconce  
Warm Brass Finish  
6-1/8"W x 12-3/8"H x 6"E  
Adj E 6" - 12"  
1E 60W  
White Fabric Shade  
Decorative Pull-Chain

**G. 9-0900CP-1-13**

1-Light Adjustable  
Sconce  
English Bronze Finish  
6-1/8"W x 12-3/8"H x 6"E  
Adj E 6" - 12"  
1E 60W  
White Fabric Shade  
Decorative Pull-Chain

**H. 9-0900CP-1-89**

1-Light Adjustable  
Sconce  
Matte Black Finish  
6-1/8"W x 12-3/8"H x 6"E  
Adj E 6" - 12"  
1E 60W  
White Fabric Shade  
Decorative Pull-Chain

**I. 9-0900CP-1-109**

1-Light Adjustable  
Sconce  
Polished Nickel Finish  
6-1/8"W x 12-3/8"H x 6"E  
Adj E 6" - 12"  
1E 60W  
White Fabric Shade  
Decorative Pull-Chain

**J. 9-0900CP-1-SN**

1-Light Adjustable  
Sconce  
Satin Nickel Finish  
6-1/8"W x 12-3/8"H x 6"E  
Adj E 6" - 12"  
1E 60W  
White Fabric Shade  
Decorative Pull-Chain

# DAKOTA

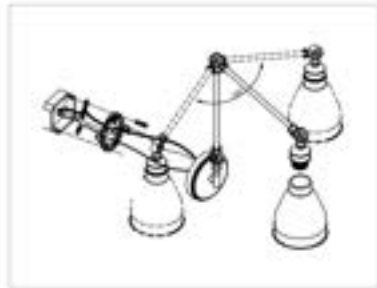

**A. 9-960-1-89**  
1-Light Adjustable  
Sconce  
Matte Black Finish  
5-1/2"W x 17"H x 13"E  
Adj E 13" - 33-3/4"  
1E 60W

**B. 9-960-1-13**  
1-Light Adjustable  
Sconce  
English Bronze Finish  
5-1/2"W x 17"H x 13"E  
Adj E 13" - 33-3/4"  
1E 60W

**C. 9-960-1-322**  
1-Light Adjustable  
Sconce  
Warm Brass Finish  
5-1/2"W x 17"H x 13"E  
Adj E 13" - 33-3/4"  
1E 60W

**D. 9-960-1-5N**  
1-Light Adjustable  
Sconce  
Satin Nickel Finish  
5-1/2"W x 17"H x 13"E  
Adj E 13" - 33-3/4"  
1E 60W

**E. 9-960-1-109**  
1-Light Adjustable  
Sconce  
Polished Nickel Finish  
5-1/2"W x 17"H x 13"E  
Adj E 13" - 33-3/4"  
1E 60W

# DRAKE



F.



H.



I.



J.



G.

**F. 9-9131CP-1-13**

1-Light Adjustable  
Sconce  
English Bronze Finish  
7-1/2"W x 17-1/2"H x  
14"E  
Adj E 14" - 34-1/2"  
1E 60W  
Clear Glass

**G. 9-9131CP-1-89**

1-Light Adjustable  
Sconce  
Matte Black Finish  
7-1/2"W x 17-1/2"H x  
14"E  
Adj E 14" - 34-1/2"  
1E 60W  
Clear Glass

**H. 9-9131CP-1-322**

1-Light Adjustable  
Sconce  
Warm Brass Finish  
7-1/2"W x 17-1/2"H x  
14"E  
Adj E 14" - 34-1/2"  
1E 60W  
Clear Glass

**I. 9-9131CP-1-109**

1-Light Adjustable  
Sconce  
Polished Nickel Finish  
7-1/2"W x 17-1/2"H x  
14"E  
Adj E 14" - 34-1/2"  
1E 60W  
Clear Glass

**J. 9-9131CP-1-SN**

1-Light Adjustable  
Sconce  
Satin Nickel Finish  
7-1/2"W x 17-1/2"H x  
14"E  
Adj E 14" - 34-1/2"  
1E 60W  
Clear Glass

Includes cord, plug, and hardwire hardware

# WALL LIGHTING

## A. MELROSE

**9-6836-1-11**  
1-Light Sconce  
Polished Chrome Finish  
5"W x 7-3/4"H x 6-3/4"E  
1E 60W  
White Opal Etched Glass



A.

## B. MELROSE

**9-6836-1-13**  
1-Light Sconce  
English Bronze Finish  
5"W x 7-3/4"H x 6-3/4"E  
1E 60W  
White Opal Etched Glass



B.



C.

## C. MELROSE

**9-6836-1-SN**  
1-Light Sconce  
Satin Nickel Finish  
5"W x 7-3/4"H x 6-3/4"E  
1E 60W  
White Opal Etched Glass

## D. MELROSE

**9-6836-1-322**  
1-Light Sconce  
Warm Brass Finish  
5"W x 7-3/4"H x 6-3/4"E  
1E 60W  
White Opal Etched Glass



D.



E.



F.

## E. HERNDON

**9-1007-1-SN**  
1-Light Sconce  
Satin Nickel Finish  
5-1/2"W x 10-3/4"H x 7-1/2"E  
1E 60W  
Frosted White Glass

## F. HAMPTON

**9-1972-1-322**  
1-Light Sconce  
Warm Brass Finish  
4-3/4"W x 9-7/8"H x 6-1/2"E  
1E 60W  
Clear Cracked Glass

## G. COLTON

**9-337-1-13**  
1-Light Sconce  
English Bronze Finish  
4-3/4"W x 10"H x 6"E  
1E 60W  
White Opal Glass



G.

## H. COLTON

**9-337-1-SN**  
1-Light Sconce  
Satin Nickel Finish  
4-3/4"W x 10"H x 6"E  
1E 60W  
White Opal Glass



H.



# WALL LIGHTING



I.



J.



K.



L.



M.



N.



O.



P.



Q.

**I. CARSON****9-4050-1-322**

1-Light Sconce  
Warm Brass Finish  
5-1/2"W x 8-1/2"H x 7"E  
1E 60W  
Clear Glass

**J. CARSON****9-4050-1-BK**

1-Light Sconce  
Matte Black Finish  
5-1/2"W x 8-1/2"H x 7"E  
1E 60W  
Clear Glass

**K. CARSON****9-4050-1-SN**

1-Light Sconce  
Satin Nickel Finish  
5-1/2"W x 8-1/2"H x 7"E  
1E 60W  
Clear Glass

**L. OCTAVE****9-4030-1-322**

1-Light Sconce  
Warm Brass Finish  
5"W x 9-1/2"H x 6"E  
1E 60W  
Clear Glass

**M. OCTAVE****9-4030-1-BK**

1-Light Sconce  
Matte Black Finish  
5"W x 9-1/2"H x 6"E  
1E 60W  
Clear Glass

**N. OCTAVE****9-4030-1-SN**

1-Light Sconce  
Satin Nickel Finish  
5"W x 9-1/2"H x 6"E  
1E 60W  
Clear Glass

**O. OCTAVE****9-4030-1-13**

1-Light Sconce  
English Bronze Finish  
5"W x 9-1/2"H x 6"E  
1E 60W  
Clear Glass

**P. OCTAVE****9-4030-1-11**

1-Light Sconce  
Polished Chrome Finish  
5"W x 9-1/2"H x 6"E  
1E 60W  
Clear Glass

**Q. ELISE****8-9127-1-SN**

1-Light Sconce  
Satin Nickel Finish  
4-1/2"W x 10-1/2"H x 6-1/2"E  
1E 60W  
Frosted Opal Glass

# GARNET



- |   |   |  |   |
|---|---|--|---|
| <p><b>A. 9-6001-1-322</b><br/>                 1-Light Sconce<br/>                 Warm Brass Finish<br/>                 5-1/2"W x 20-1/2"H x 7"E<br/>                 1E 60W<br/>                 Clear Crystal</p> | <p><b>B. 9-6001-1-89</b><br/>                 1-Light Sconce<br/>                 Matte Black Finish<br/>                 5-1/2"W x 20-1/2"H x 7"E<br/>                 1E 60W<br/>                 Clear Crystal</p> | <p><b>C. 9-6001-1-109</b><br/>                 1-Light Sconce<br/>                 Polished Nickel Finish<br/>                 5-1/2"W x 20-1/2"H x 7"E<br/>                 1E 60W<br/>                 Clear Crystal</p> | <p><b>D. 8-6001-4-322</b><br/>                 4-Light Bath Bar<br/>                 Warm Brass Finish<br/>                 32"W x 9-1/2"H x 7"E<br/>                 4E 60W<br/>                 Clear Crystal</p> |
|---|---|--|---|

# GARNET



D.

**E. 8-6001-3-322**  
 3-Light Bath Bar  
 Warm Brass Finish  
 24"W x 9-1/2"H x 7"E  
 3E 60W  
 Clear Crystal



E.

F.

**F. 8-6001-2-322**  
 2-Light Bath Bar  
 Warm Brass Finish  
 16"W x 9-1/2"H x 7"E  
 2E 60W  
 Clear Crystal



**G. 8-6001-4-BK**  
 4-Light Bath Bar  
 Matte Black Finish  
 32"W x 9-1/2"H x 7"E  
 4E 60W  
 Clear Crystal



G.

**H. 8-6001-3-BK**  
 3-Light Bath Bar  
 Matte Black Finish  
 24"W x 9-1/2"H x 7"E  
 3E 60W  
 Clear Crystal



H.

I.

**I. 8-6001-2-BK**  
 2-Light Bath Bar  
 Matte Black Finish  
 16"W x 9-1/2"H x 7"E  
 2E 60W  
 Clear Crystal



**J. 8-6001-4-109**  
 4-Light Bath Bar  
 Polished Nickel Finish  
 32"W x 9-1/2"H x 7"E  
 4E 60W  
 Clear Crystal



J.

**K. 8-6001-3-109**  
 3-Light Bath Bar  
 Polished Nickel Finish  
 24"W x 9-1/2"H x 7"E  
 3E 60W  
 Clear Crystal



K.

L.

**L. 8-6001-2-109**  
 2-Light Bath Bar  
 Polished Nickel Finish  
 16"W x 9-1/2"H x 7"E  
 2E 60W  
 Clear Crystal



Fixtures may be mounted either uplight or downlight

# CHANTILLY



Fixtures may be mounted either uplight or downlight

250 SAVOYHOUSE.COM | 800 801 1621

# CHANTILLY



A.



B.



C.



D.



E.



F.



G.



H.



I.

**A. 8-1745-4-BK**  
4-Light Bath Bar  
Matte Black Finish  
30-1/2"W x 10"H x 7"E  
4E 60W  
Clear Ribbed Glass

**B. 8-1745-3-BK**  
3-Light Bath Bar  
Matte Black Finish  
22"W x 10"H x 7"E  
3E 60W  
Clear Ribbed Glass

**C. 8-1745-2-BK**  
2-Light Bath Bar  
Matte Black Finish  
14"W x 10"H x 7"E  
2E 60W  
Clear Ribbed Glass

**D. 8-1745-4-322**  
4-Light Bath Bar  
Warm Brass Finish  
30-1/2"W x 10"H x 7"E  
4E 60W  
Clear Ribbed Glass

**E. 8-1745-3-322**  
3-Light Bath Bar  
Warm Brass Finish  
22"W x 10"H x 7"E  
3E 60W  
Clear Ribbed Glass

**F. 8-1745-2-322**  
2-Light Bath Bar  
Warm Brass Finish  
14"W x 10"H x 7"E  
2E 60W  
Clear Ribbed Glass

**G. 8-1745-4-109**  
4-Light Bath Bar  
Polished Nickel Finish  
30-1/2"W x 10"H x 7"E  
4E 60W  
Clear Ribbed Glass

**H. 8-1745-3-109**  
3-Light Bath Bar  
Polished Nickel Finish  
22"W x 10"H x 7"E  
3E 60W  
Clear Ribbed Glass

**I. 8-1745-2-109**  
2-Light Bath Bar  
Polished Nickel Finish  
14"W x 10"H x 7"E  
2E 60W  
Clear Ribbed Glass

# CALHOUN



Fixtures may be mounted either uplight or downlight.

252 SAVOYHOUSE.COM | 800 801 1621

# CALHOUN



# BALLAS



Fixtures may be mounted either uplight or downlight.

254 SAVOYHOUSE.COM | 800 801 1621



# BALLAS

**A. B-5606-4-BK**  
 4-Light Bath Bar  
 Matte Black Finish  
 31-1/2"W x 9-3/4"H x 6-1/2"E  
 4E 60W  
 Clear Hammered Glass



**B. B-5606-3-BK**  
 3-Light Bath Bar  
 Matte Black Finish  
 23-1/2"W x 9-3/4"H x 6-1/2"E  
 3E 60W  
 Clear Hammered Glass



**C. B-5606-2-BK**  
 2-Light Bath Bar  
 Matte Black Finish  
 15-1/2"W x 9-3/4"H x 6-1/2"E  
 2E 60W  
 Clear Hammered Glass



**D. B-5606-4-SN**  
 4-Light Bath Bar  
 Satin Nickel Finish  
 31-1/2"W x 9-3/4"H x 6-1/2"E  
 4E 60W  
 Clear Hammered Glass



**E. B-5606-3-SN**  
 3-Light Bath Bar  
 Satin Nickel Finish  
 23-1/2"W x 9-3/4"H x 6-1/2"E  
 3E 60W  
 Clear Hammered Glass



**F. B-5606-2-SN**  
 2-Light Bath Bar  
 Satin Nickel Finish  
 15-1/2"W x 9-3/4"H x 6-1/2"E  
 2E 60W  
 Clear Hammered Glass



# SACREMENTO



Fixtures may be mounted either uplight or downlight.

---

256 SAVOYHOUSE.COM | 800 801 1621

# SACREMENTO



# GORDON



Fixtures may be mounted either uplight or downlight.

# GORDON



**A. 8-2603-6-BK**  
6-Light Bath Bar  
Matte Black Finish  
34"W x 8-3/4"H x 5-1/2"E  
6E 60W  
Clear Water Glass

**B. 8-2603-4-BK**  
4-Light Bath Bar  
Matte Black Finish  
22"W x 8-3/4"H x 5-1/2"E  
4E 60W  
Clear Water Glass

**C. 8-2603-6-CH**  
6-Light Bath Bar  
Polished Chrome Finish  
34"W x 8-3/4"H x 5-1/2"E  
6E 60W  
Clear Water Glass

**D. 8-2603-4-CH**  
4-Light Bath Bar  
Polished Chrome Finish  
22"W x 8-3/4"H x 5-1/2"E  
4E 60W  
Clear Water Glass

# MASON



Fixtures may be mounted either uplight or downlight.

260 SAVOYHOUSE.COM | 800 801 1621

# MASON

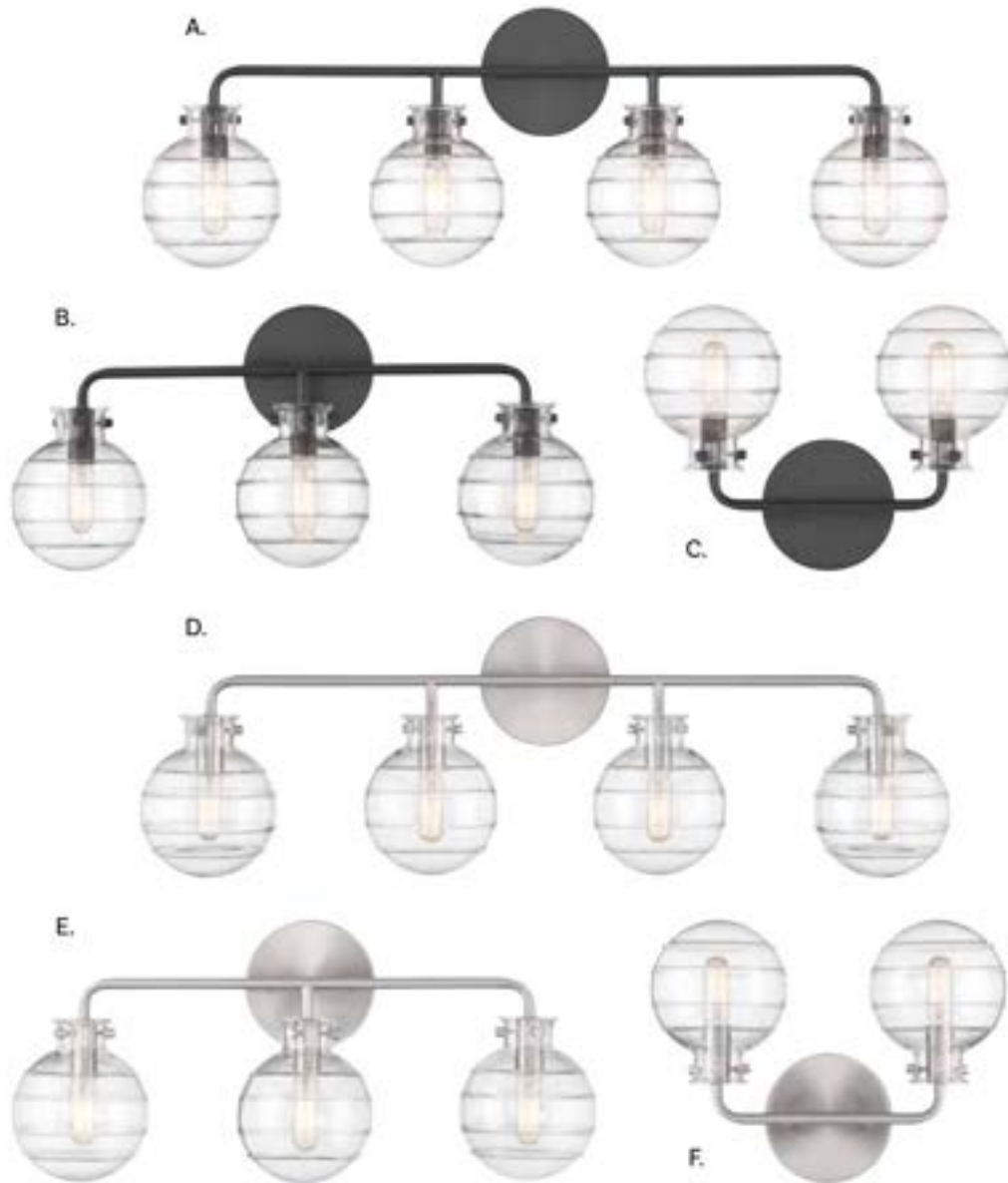

- |                       |                       |                       |                       |                       |                       |
|-----------------------|-----------------------|-----------------------|-----------------------|-----------------------|-----------------------|
| <b>A. 8-4300-4-BK</b> | <b>B. 8-4300-3-BK</b> | <b>C. 8-4300-2-BK</b> | <b>D. 8-4300-4-SN</b> | <b>E. 8-4300-3-SN</b> | <b>F. 8-4300-2-SN</b> |
| 4-Light Bath Bar      | 3-Light Bath Bar      | 2-Light Bath Bar      | 4-Light Bath Bar      | 3-Light Bath Bar      | 2-Light Bath Bar      |
| Matte Black Finish    | Matte Black Finish    | Matte Black Finish    | Satin Nickel Finish   | Satin Nickel Finish   | Satin Nickel Finish   |
| 30-1/2"W x 10"H x     | 22"W x 10"H x         | 13-1/2"W x 10"H x     | 30-1/2"W x 10"H x     | 22"W x 10"H x         | 13-1/2"W x 10"H x     |
| 6-1/4"E               | 6-1/4"E               | 6-1/4"E               | 6-1/4"E               | 6-1/4"E               | 6-1/4"E               |
| 4C 60W                | 3C 60W                | 2C 60W                | 4C 60W                | 3C 60W                | 2C 60W                |
| Clear Swirl Glass     | Clear Swirl Glass     | Clear Swirl Glass     | Clear Swirl Glass     | Clear Swirl Glass     | Clear Swirl Glass     |

# CARSON



**A. 8-4050-4-SN**  
 4-Light Bath Bar  
 Satin Nickel Finish  
 30"W x 8-1/2"H x 7"E  
 4E 60W  
 Clear Glass



A.

**B. 8-4050-3-SN**  
 3-Light Bath Bar  
 Satin Nickel Finish  
 22-1/2"W x 8-1/2"H x 7"E  
 3E 60W  
 Clear Glass



B.

**C. 9-4050-1-SN**  
 1-Light Sconce  
 Satin Nickel Finish  
 5-1/2"W x 8-1/2"H x 7"E  
 1E 60W  
 Clear Glass



C.

**D. 8-4050-2-SN**  
 2-Light Bath Bar  
 Satin Nickel Finish  
 14"W x 8-1/2"H x 7"E  
 2E 60W  
 Clear Glass



D.



# CARSON



E.

**E. 8-4050-4-BK**  
4-Light Bath Bar  
Matte Black Finish  
30"W x 8-1/2"H x 7"E  
4E 60W  
Clear Glass



F.

**F. 8-4050-3-BK**  
3-Light Bath Bar  
Matte Black Finish  
22-1/2"W x 8-1/2"H x 7"E  
3E 60W  
Clear Glass



G.

**G. 8-4050-2-BK**  
2-Light Bath Bar  
Matte Black Finish  
14"W x 8-1/2"H x 7"E  
2E 60W  
Clear Glass



H.

**H. 9-4050-1-BK**  
1-Light Sconce  
Matte Black Finish  
5-1/2"W x 8-1/2"H x 7"E  
1E 60W  
Clear Glass



I.

**I. 8-4050-4-322**  
4-Light Bath Bar  
Warm Brass Finish  
30"W x 8-1/2"H x 7"E  
4E 60W  
Clear Glass



J.

**J. 8-4050-3-322**  
3-Light Bath Bar  
Warm Brass Finish  
22-1/2"W x 8-1/2"H x 7"E  
3E 60W  
Clear Glass



K.

**K. 8-4050-2-322**  
2-Light Bath Bar  
Warm Brass Finish  
14"W x 8-1/2"H x 7"E  
2E 60W  
Clear Glass



L.

**L. 9-4050-1-322**  
1-Light Sconce  
Warm Brass Finish  
5-1/2"W x 8-1/2"H x 7"E  
1E 60W  
Clear Glass

Fixtures may be mounted either uplight or downlight.

# WRIGHT



A.



B.

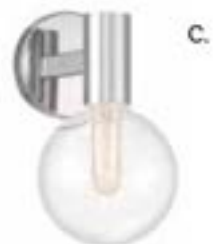

C.

**A. 9-3076-1-89**  
 1-Light Sconce  
 Matte Black Finish  
 5-3/4"W x 10"H x 7-1/2"E  
 1E 60W  
 Clear Glass

**B. 9-3076-1-322**  
 1-Light Sconce  
 Warm Brass Finish  
 5-3/4"W x 10"H x 7-1/2"E  
 1E 60W  
 Clear Glass

**C. 9-3076-1-11**  
 1-Light Sconce  
 Polished Chrome Finish  
 5-3/4"W x 10"H x 7-1/2"E  
 1E 60W  
 Clear Glass

# WRIGHT

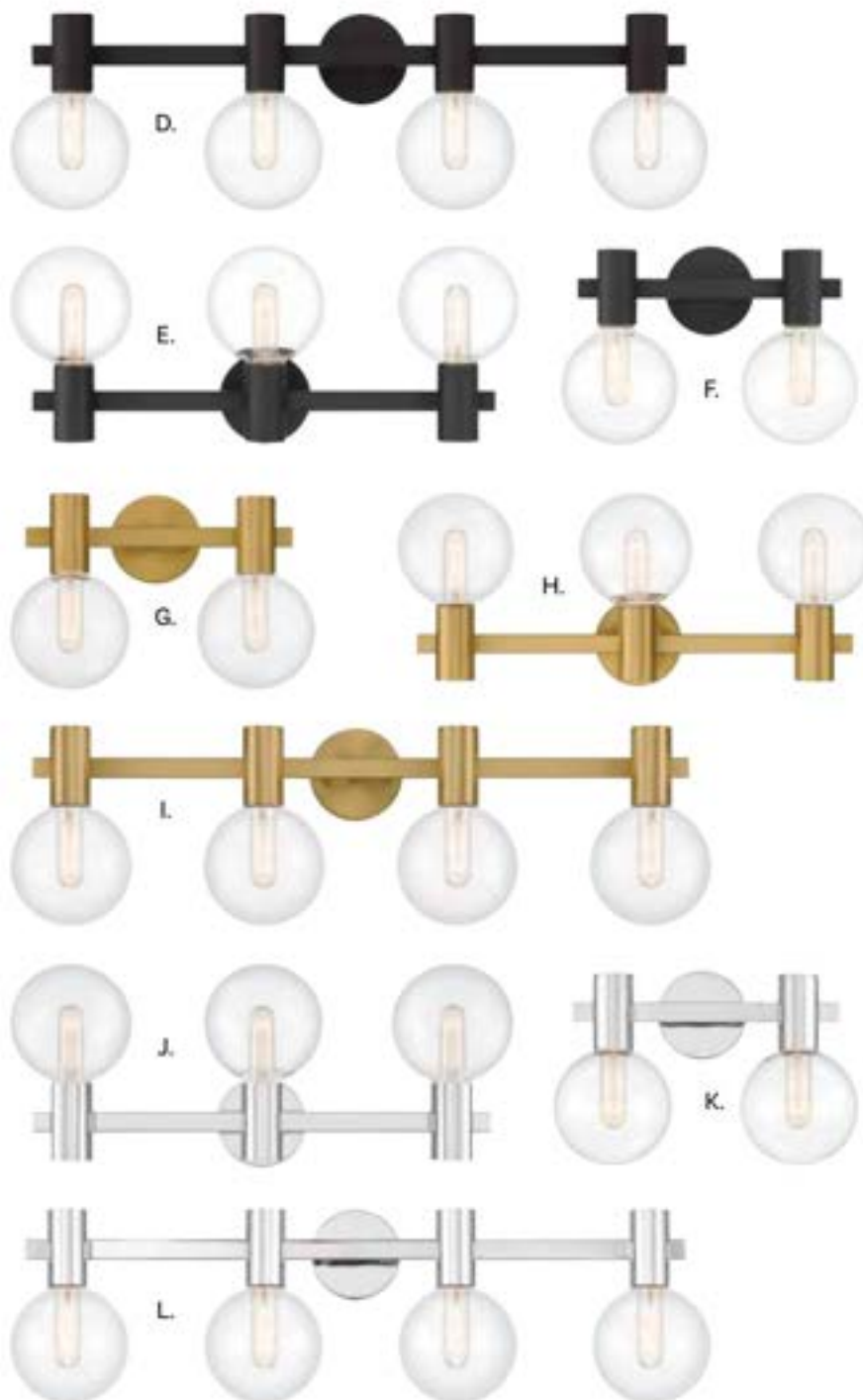

- D. 8-3076-4-BK**  
4-Light Bath Bar  
Matte Black Finish  
34"W x 10"H x 7-1/2"E  
4E 60W  
Clear Glass
- E. 8-3076-3-BK**  
3-Light Bath Bar  
Matte Black Finish  
25"W x 10"H x 7-1/2"E  
3E 60W  
Clear Glass
- F. 8-3076-2-BK**  
2-Light Bath Bar  
Matte Black Finish  
15-1/2"W x 10"H x 7-1/2"E  
2E 60W  
Clear Glass
- G. 8-3076-2-322**  
2-Light Bath Bar  
Warm Brass Finish  
15-1/2"W x 10"H x 7-1/2"E  
2E 60W  
Clear Glass
- H. 8-3076-3-322**  
3-Light Bath Bar  
Warm Brass Finish  
25"W x 10"H x 7-1/2"E  
3E 60W  
Clear Glass
- I. 8-3076-4-322**  
4-Light Bath Bar  
Warm Brass Finish  
34"W x 10"H x 7-1/2"E  
4E 60W  
Clear Glass
- J. 8-3076-3-11**  
3-Light Bath Bar  
Polished Chrome Finish  
25"W x 10"H x 7-1/2"E  
3E 60W  
Clear Glass
- K. 8-3076-2-11**  
2-Light Bath Bar  
Polished Chrome Finish  
15-1/2"W x 10"H x 7-1/2"E  
2E 60W  
Clear Glass
- L. 8-3076-4-11**  
4-Light Bath Bar  
Polished Chrome Finish  
34"W x 10"H x 7-1/2"E  
4E 60W  
Clear Glass

Fixtures may be mounted either upright or downlight

# CROSBY

- A. 8-1860-4-322**  
4-Light Bath Bar  
Warm Brass Finish  
33"W x 10-1/2"H x 7-1/2"E  
4C 60W  
Clear Glass
- B. 8-1860-3-322**  
3-Light Bath Bar  
Warm Brass Finish  
24"W x 10-1/2"H x 7-1/2"E  
3C 60W  
Clear Glass
- C. 8-1860-2-322**  
2-Light Bath Bar  
Warm Brass Finish  
16"W x 10-1/2"H x 7-1/2"E  
2C 60W  
Clear Glass
- D. 8-1860-2-BK**  
2-Light Bath Bar  
Matte Black Finish  
16"W x 10-1/2"H x 7-1/2"E  
2C 60W  
Clear Glass
- E. 8-1860-3-BK**  
3-Light Bath Bar  
Matte Black Finish  
24"W x 10-1/2"H x 7-1/2"E  
3C 60W  
Clear Glass
- F. 8-1860-4-BK**  
4-Light Bath Bar  
Matte Black Finish  
33"W x 10-1/2"H x 7-1/2"E  
4C 60W  
Clear Glass



# CROSBY



# OCTAVE



Fixtures may be mounted either upright or downlight.

268 SAVOYHOUSE.COM | 800 801 1621

# OCTAVE



**A. 8-4030-2-BK**  
2-Light Bath Bar  
Matte Black Finish  
13-3/4"W x 9"H x 5-1/2"E  
2E 60W  
Clear Glass

**B. 9-4030-1-BK**  
1-Light Sconce  
Matte Black Finish  
5"W x 9-1/2"H x 6"E  
1E 60W  
Clear Glass

**C. 8-4030-3-BK**  
3-Light Bath Bar  
Matte Black Finish  
21"W x 9"H x 5-1/2"E  
3E 60W  
Clear Glass

**D. 8-4030-4-BK**  
4-Light Bath Bar  
Matte Black Finish  
28-3/4"W x 9"H x 5-1/2"E  
4E 60W  
Clear Glass

**E. 8-4030-2-T1**  
2-Light Bath Bar  
Polished Chrome Finish  
13-3/4"W x 9"H x 5-1/2"E  
2E 60W  
Clear Glass

**F. 9-4030-1-T1**  
1-Light Sconce  
Polished Chrome Finish  
5"W x 9-1/2"H x 6"E  
1E 60W  
Clear Glass

**G. 8-4030-3-T1**  
3-Light Bath Bar  
Polished Chrome Finish  
21"W x 9"H x 5-1/2"E  
3E 60W  
Clear Glass

**H. 8-4030-4-T1**  
4-Light Bath Bar  
Polished Chrome Finish  
28-3/4"W x 9"H x 5-1/2"E  
4E 60W  
Clear Glass

# OCTAVE

**A. 9-4030-1-13**

1-Light Sconce  
English Bronze Finish  
5"W x 9-1/2"H x 6"E  
1E 60W  
Clear Glass



A.

**B. 8-4030-2-13**

2-Light Bath Bar  
English Bronze Finish  
13-3/4"W x 9"H x 5-1/2"E  
2E 60W  
Clear Glass



B.

**C. 8-4030-3-13**

3-Light Bath Bar  
English Bronze Finish  
21"W x 9"H x 5-1/2"E  
3E 60W  
Clear Glass



C.

**D. 8-4030-4-13**

4-Light Bath Bar  
English Bronze Finish  
28-3/4"W x 9"H x 5-1/2"E  
4E 60W  
Clear Glass



D.

**E. 9-4030-1-322**

1-Light Sconce  
Warm Brass Finish  
5"W x 9-1/2"H x 6"E  
1E 60W  
Clear Glass



E.

**F. 8-4030-2-322**

2-Light Bath Bar  
Warm Brass Finish  
13-3/4"W x 9"H x 5-1/2"E  
2E 60W  
Clear Glass



F.

**G. 8-4030-3-322**

3-Light Bath Bar  
Warm Brass Finish  
21"W x 9"H x 5-1/2"E  
3E 60W  
Clear Glass



G.

**H. 8-4030-4-322**

4-Light Bath Bar  
Warm Brass Finish  
28-3/4"W x 9"H x 5-1/2"E  
4E 60W  
Clear Glass



H.

Fixtures may be mounted either upright or downlight.



# OCTAVE



I.



K.



L.



J.

**I. 8-4030-2-SN**  
2-Light Bath Bar  
Satin Nickel Finish  
13-3/4"W x 9"H x 5-1/2"E  
2E 60W  
Clear Glass

**J. 9-4030-1-SN**  
1-Light Sconce  
Satin Nickel Finish  
5"W x 9-1/2"H x 6"E  
1E 60W  
Clear Glass

**K. 8-4030-3-SN**  
3-Light Bath Bar  
Satin Nickel Finish  
21"W x 9"H x 5-1/2"E  
3E 60W  
Clear Glass

**L. 8-4030-4-SN**  
4-Light Bath Bar  
Satin Nickel Finish  
28-3/4"W x 9"H x 5-1/2"E  
4E 60W  
Clear Glass

# LAKEWOOD



# LAKEWOOD



A.



B.



C.



D.



E.



F.



G.



H.

**A. 9-1830-1-89**  
1-Light Sconce  
Matte Black Finish  
5-1/2"W x 9-1/2"H x 6-1/2"E  
1E 60W  
Clear Glass

**B. 8-1830-2-BK**  
2-Light Bath Bar  
Matte Black Finish  
16"W x 9-1/2"H x 6-1/2"E  
2E 60W  
Clear Glass

**C. 8-1830-3-BK**  
3-Light Bath Bar  
Matte Black Finish  
24"W x 9-1/2"H x 6-1/2"E  
3E 60W  
Clear Glass

**D. 8-1830-4-BK**  
4-Light Bath Bar  
Matte Black Finish  
32"W x 9-1/2"H x 6-1/2"E  
4E 60W  
Clear Glass

**E. 8-1830-4-322**  
4-Light Bath Bar  
Warm Brass Finish  
32"W x 9-1/2"H x 6-1/2"E  
4E 60W  
Clear Glass

**F. 8-1830-3-322**  
3-Light Bath Bar  
Warm Brass Finish  
24"W x 9-1/2"H x 6-1/2"E  
3E 60W  
Clear Glass

**G. 9-1830-1-322**  
1-Light Sconce  
Warm Brass Finish  
5-1/2"W x 9-1/2"H x 6-1/2"E  
1E 60W  
Clear Glass

**H. 8-1830-2-322**  
2-Light Bath Bar  
Warm Brass Finish  
16"W x 9-1/2"H x 6-1/2"E  
2E 60W  
Clear Glass

# DRAKE

---



# DRAKE



- A. 8-9130-4-322**  
4-Light Bath Bar  
Warm Brass Finish  
38"W x 10"H x 7-1/2"E  
4E 60W  
Clear Glass
- B. 8-9130-3-322**  
3-Light Bath Bar  
Warm Brass Finish  
28-1/2"W x 10"H x 7-1/2"E  
3E 60W  
Clear Glass
- C. 8-9130-2-322**  
2-Light Bath Bar  
Warm Brass Finish  
17-3/4"W x 10"H x 7-1/2"E  
2E 60W  
Clear Glass
- D. 8-9130-2-BK**  
2-Light Bath Bar  
Matte Black Finish  
17-3/4"W x 10"H x 7-1/2"E  
2E 60W  
Clear Glass
- E. 8-9130-3-BK**  
3-Light Bath Bar  
Matte Black Finish  
28-1/2"W x 10"H x 7-1/2"E  
3E 60W  
Clear Glass
- F. 8-9130-4-BK**  
4-Light Bath Bar  
Matte Black Finish  
38"W x 10"H x 7-1/2"E  
4E 60W  
Clear Glass

Fixtures may be mounted either uplight or downlight.

# DRAKE



<b>A. 8-9130-4-109</b>	<b>B. 8-9130-3-109</b>	<b>C. 8-9130-2-109</b>	<b>D. 8-9130-2-13</b>	<b>E. 8-9130-3-13</b>	<b>F. 8-9130-4-13</b>
4-Light Bath Bar	3-Light Bath Bar	2-Light Bath Bar	2-Light Bath Bar	3-Light Bath Bar	4-Light Bath Bar
Polished Nickel	Polished Nickel	Polished Nickel	English Bronze	English Bronze	English Bronze
Finish	Finish	Finish	Finish	Finish	Finish
38"W x 10"H x	28-1/2"W x 10"H x	17-3/4"W x 10"H x	17-3/4"W x 10"H x	28-1/2"W x 10"H x	38"W x 10"H x
7-1/2"E	7-1/2"E	7-1/2"E	7-1/2"E	7-1/2"E	7-1/2"E
4E 60W	3E 60W	2E 60W	2E 60W	3E 60W	4E 60W
Clear Glass	Clear Glass	Clear Glass	Clear Glass	Clear Glass	Clear Glass

# DRAKE



Fixtures may be mounted either uplight or downlight.

# MARSHALL



Fixtures may be mounted either upright or downlight.



# MARSHALL



A.



B.



C.

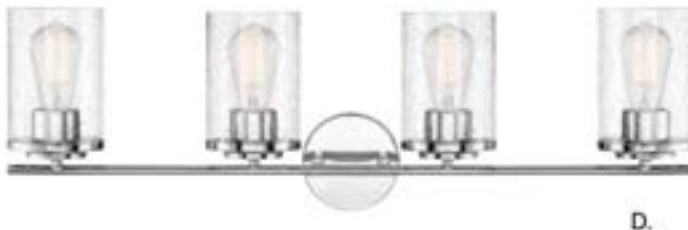

D.



E.



F.

- A. 8-8020-4-BK**  
4-Light Bath Bar  
Matte Black Finish  
31"W x 9-1/2"H x 6-1/2"E  
4E 60W  
Clear Seeded Glass
- B. 8-8020-3-BK**  
3-Light Bath Bar  
Matte Black Finish  
22"W x 9-1/2"H x 6-1/2"E  
3E 60W  
Clear Seeded Glass
- C. 8-8020-2-BK**  
2-Light Bath Bar  
Matte Black Finish  
13-1/4"W x 9-1/2"H x 6-1/2"E  
2E 60W  
Clear Seeded Glass
- D. 8-8020-4-11**  
4-Light Bath Bar  
Polished Chrome Finish  
31"W x 9-1/2"H x 6-1/2"E  
4E 60W  
Clear Seeded Glass
- E. 8-8020-3-11**  
3-Light Bath Bar  
Polished Chrome Finish  
22"W x 9-1/2"H x 6-1/2"E  
3E 60W  
Clear Seeded Glass
- F. 8-8020-2-11**  
2-Light Bath Bar  
Polished Chrome Finish  
13-1/4"W x 9-1/2"H x 6-1/2"E  
2E 60W  
Clear Seeded Glass

# VALE



Fixtures may be mounted either uplight or downlight.

280 SAVOYHOUSE.COM | 800 801 1621

## VALE



- A. 8-7205-4-BK**  
 4-Light Bath Bar  
 Matte Black Finish  
 33"W x 9-3/4"H x 7-1/4"E  
 4E 60W  
 Clear Glass



- B. 8-7205-3-BK**  
 3-Light Bath Bar  
 Matte Black Finish  
 24"W x 9-3/4"H x 7-1/4"E  
 3E 60W  
 Clear Glass



- C. 8-7205-2-BK**  
 2-Light Bath Bar  
 Matte Black Finish  
 14-3/4"W x 9-3/4"H x 7-1/4"E  
 2E 60W  
 Clear Glass



- D. 8-7205-4-SN**  
 4-Light Bath Bar  
 Satin Nickel Finish  
 33"W x 9-3/4"H x 7-1/4"E  
 4E 60W  
 Clear Glass



- E. 8-7205-3-SN**  
 3-Light Bath Bar  
 Satin Nickel Finish  
 24"W x 9-3/4"H x 7-1/4"E  
 3E 60W  
 Clear Glass



- F. 8-7205-2-SN**  
 2-Light Bath Bar  
 Satin Nickel Finish  
 14-3/4"W x 9-3/4"H x 7-1/4"E  
 2E 60W  
 Clear Glass

# CAPRA

**A. 8-4090-4-109**  
4-Light Bath Bar  
Polished Nickel Finish  
31"W x 9"H x 6-1/2"E  
4E 60W  
White Opal Glass



**B. 8-4090-3-109**  
3-Light Bath Bar  
Polished Nickel Finish  
22"W x 9"H x 6-1/2"E  
3E 60W  
White Opal Glass



**C. 8-4090-2-109**  
2-Light Bath Bar  
Polished Nickel Finish  
15"W x 9"H x 6-1/2"E  
2E 60W  
White Opal Glass



**D. 8-4090-4-322**  
4-Light Bath Bar  
Warm Brass Finish  
31"W x 9"H x 6-1/2"E  
4E 60W  
White Opal Glass



**E. 8-4090-3-322**  
3-Light Bath Bar  
Warm Brass Finish  
22"W x 9"H x 6-1/2"E  
3E 60W  
White Opal Glass



**F. 8-4090-2-322**  
2-Light Bath Bar  
Warm Brass Finish  
15"W x 9"H x 6-1/2"E  
2E 60W  
White Opal Glass



# CAPRA



Fixtures may be mounted either uplight or downlight.

# KADEN



Fixtures may be mounted either uplight or downlight

284 SAVOYHOUSE.COM | 800 801 1621

# KADEN

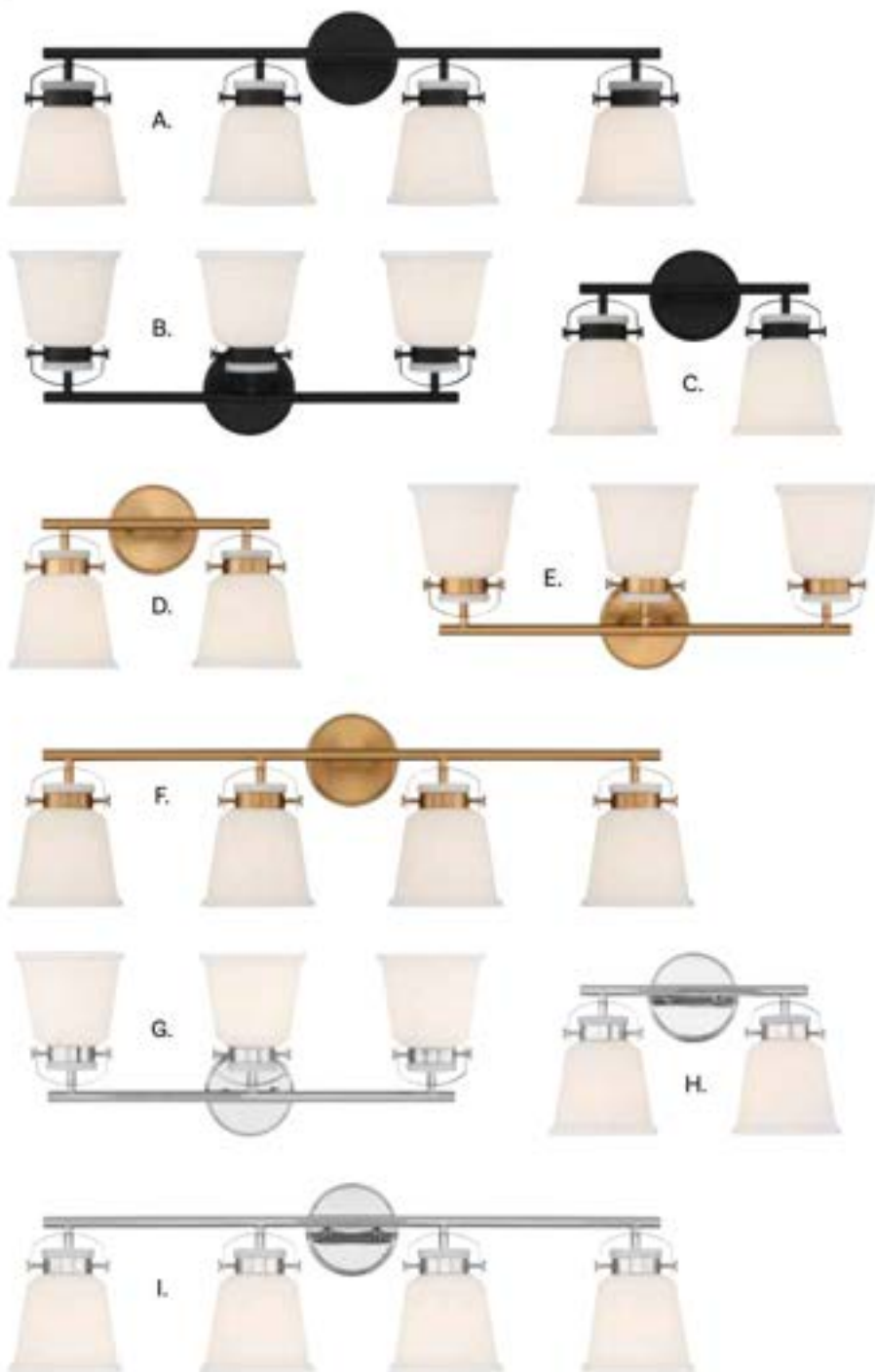

- A. 8-1627-4-BK**  
4-Light Bath Bar  
Matte Black Finish  
34"W x 10-1/2"H x 7"E  
4E 60W  
White Opal Glass
- B. 8-1627-3-BK**  
3-Light Bath Bar  
Matte Black Finish  
26"W x 10-1/2"H x 7"E  
3E 60W  
White Opal Glass
- C. 8-1627-2-BK**  
2-Light Bath Bar  
Matte Black Finish  
16"W x 10-1/2"H x 7"E  
2E 60W  
White Opal Glass
- D. 8-1627-2-322**  
2-Light Bath Bar  
Warm Bath Bar  
16"W x 10-1/2"H x 7"E  
2E 60W  
White Opal Glass
- E. 8-1627-3-322**  
3-Light Bath Bar  
Warm Brass Finish  
26"W x 10-1/2"H x 7"E  
3E 60W  
White Opal Glass
- F. 8-1627-4-322**  
4-Light Bath Bar  
Warm Brass Finish  
34"W x 10-1/2"H x 7"E  
4E 60W  
White Opal Glass
- G. 8-1627-3-11**  
3-Light Bath Bar  
Polished Chrome Finish  
26"W x 10-1/2"H x 7"E  
3E 60W  
White Opal Glass
- H. 8-1627-2-11**  
2-Light Bath Bar  
Polished Chrome Finish  
16"W x 10-1/2"H x 7"E  
2E 60W  
White Opal Glass
- I. 8-1627-4-11**  
4-Light Bath Bar  
Polished Chrome Finish  
34"W x 10-1/2"H x 7"E  
4E 60W  
White Opal Glass

# CAMERON



**A. 8-2542-3-322**  
 3-Light Bath Bar  
 Warm Brass Finish  
 24"W x 12"H x 8"E  
 3C 40W  
 White Fabric Shades  
 Metal Candle Covers

**B. 9-2542-1-322**  
 1-Light Sconce  
 Warm Brass Finish  
 5"W x 13"H x 8"E  
 1C 40W  
 White Fabric Shade  
 Metal Candle Cover

**C. 8-2542-2-322**  
 2-Light Bath Bar  
 Warm Brass Finish  
 15"W x 12"H x 8"E  
 2C 40W  
 White Fabric Shades  
 Metal Candle Covers





## CAMERON



- D. 8-2542-3-89**  
 3-Light Bath Bar  
 Matte Black Finish  
 24"W x 12"H x 8"E  
 3C 40W  
 White Fabric Shades  
 Metal Candle Covers



- E. 8-2542-2-89**  
 2-Light Bath Bar  
 Matte Black Finish  
 15"W x 12"H x 8"E  
 2C 40W  
 White Fabric Shades  
 Metal Candle Covers



- F. 9-2542-1-89**  
 1-Light Sconce  
 Matte Black Finish  
 5"W x 13"H x 8"E  
 1C 40W  
 White Fabric Shade  
 Metal Candle Cover



- G. 8-2542-3-109**  
 3-Light Bath Bar  
 Polished Nickel Finish  
 24"W x 12"H x 8"E  
 3C 40W  
 White Fabric Shades  
 Metal Candle Covers



- H. 8-2542-2-109**  
 2-Light Bath Bar  
 Polished Nickel Finish  
 15"W x 12"H x 8"E  
 2C 40W  
 White Fabric Shades  
 Metal Candle Covers



- L. 9-2542-1-109**  
 1-Light Sconce  
 Polished Nickel Finish  
 5"W x 13"H x 8"E  
 1C 40W  
 White Fabric Shade  
 Metal Candle Cover

# MELROSE



**A. 8-6836-2-322**

2-Light Bath Bar  
Warm Brass Finish  
14-1/2"W x 7-3/4"H x 6-3/4"E  
2E 60W  
White Opal Etched Glass

**B. 8-6836-3-322**

3-Light Bath Bar  
Warm Brass Finish  
24"W x 7-3/4"H x 6-3/4"E  
3E 60W  
White Opal Etched Glass

**C. 8-6836-4-322**

4-Light Bath Bar  
Warm Brass Finish  
33-1/2"W x 7-3/4"H x 6-3/4"E  
4E 60W  
White Opal Etched Glass

**D. 9-6836-1-322**

1-Light Sconce  
Warm Brass Finish  
5"W x 7-3/4"H x 6-3/4"E  
1E 60W  
White Opal Etched Glass

# MELROSE



**E. 8-6836-2-SN**  
 2-Light Bath Bar  
 Satin Nickel Finish  
 14-1/2"W x 7-3/4"H x  
 6-3/4"E  
 2E 60W  
 White Opal Etched Glass

**F. 8-6836-3-SN**  
 3-Light Bath Bar  
 Satin Nickel Finish  
 24"W x 7-3/4"H x 6-3/4"E  
 3E 60W  
 White Opal Etched Glass

**G. 8-6836-4-SN**  
 4-Light Bath Bar  
 Satin Nickel Finish  
 33-1/2"W x 7-3/4"H x  
 6-3/4"E  
 4E 60W  
 White Opal Etched Glass

**H. 9-6836-1-SN**  
 1-Light Sconce  
 Satin Nickel Finish  
 5"W x 7-3/4"H x 6-3/4"E  
 1E 60W  
 White Opal Etched Glass

Fixtures may be mounted either upright or downlight.

# MELROSE



A.



B.



C.

D.



E.



F.



G.

H.

**A. 8-6836-2-13**  
2-Light Bath Bar  
English Bronze Finish  
14-1/2"W x 7-3/4"H x  
6-3/4"E  
2E 60W  
White Opal Etched Glass

**B. 8-6836-3-13**  
3-Light Bath Bar  
English Bronze Finish  
24"W x 7-3/4"H x 6-3/4"E  
3E 60W  
White Opal Etched Glass

**C. 8-6836-4-13**  
4-Light Bath Bar  
English Bronze Finish  
33-1/2"W x 7-3/4"H x  
6-3/4"E  
4E 60W  
White Opal Etched Glass

**D. 9-6836-1-13**  
1-Light Sconce  
English Bronze Finish  
5"W x 7-3/4"H x 6-3/4"E  
1E 60W  
White Opal Etched Glass

# MELROSE

**E. 8-6836-2-T1**

2-Light Bath Bar  
Polished Chrome Finish  
14-1/2"W x 7-3/4"H x  
6-3/4"E  
2E 60W  
White Opal Etched Glass

**F. 8-6836-3-T1**

3-Light Bath Bar  
Polished Chrome Finish  
24"W x 7-3/4"H x 6-3/4"E  
3E 60W  
White Opal Etched Glass

**G. 8-6836-4-T1**

4-Light Bath Bar  
Polished Chrome Finish  
33-1/2"W x 7-3/4"H x  
6-3/4"E  
4E 60W  
White Opal Etched Glass

**H. 9-6836-1-T1**

1-Light Sconce  
Polished Chrome Finish  
5"W x 7-3/4"H x 6-3/4"E  
1E 60W  
White Opal Etched Glass

Fixtures may be mounted either uplight or downlight.

# WHITNEY



Fixtures may be mounted either uplight or downlight

292 SAVOYHOUSE.COM | 800 801 1621

# WHITNEY



A.



B.

C.

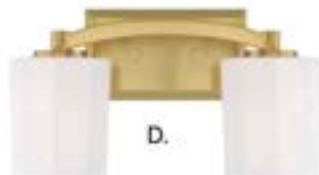

D.



E.



F.



G.

H.



I.

**A. 8-7710-4-BK**  
4-Light Bath Bar  
Matte Black Finish  
33"W x 8"H x 6-1/2"E  
4E 60W  
Fluted Opal Etched Glass

**B. 8-7710-3-BK**  
3-Light Bath Bar  
Matte Black Finish  
24"W x 8"H x 6-1/2"E  
3E 60W  
Fluted Opal Etched Glass

**C. 8-7710-2-BK**  
2-Light Bath Bar  
Matte Black Finish  
14"W x 8"H x 6-1/2"E  
2E 60W  
Fluted Opal Etched Glass

**D. 8-7710-2-322**  
2-Light Bath Bar  
Warm Brass Finish  
14"W x 8"H x 6-1/2"E  
2E 60W  
Fluted Opal Etched Glass

**E. 8-7710-3-322**  
3-Light Bath Bar  
Warm Brass Finish  
24"W x 8"H x 6-1/2"E  
3E 60W  
Fluted Opal Etched Glass

**F. 8-7710-4-322**  
4-Light Bath Bar  
Warm Brass Finish  
33"W x 8"H x 6-1/2"E  
4E 60W  
Fluted Opal Etched Glass

**G. 8-7710-3-SN**  
3-Light Bath Bar  
Satin Nickel Finish  
24"W x 8"H x 6-1/2"E  
3E 60W  
Fluted Opal Etched Glass

**H. 8-7710-2-SN**  
2-Light Bath Bar  
Satin Nickel Finish  
14"W x 8"H x 6-1/2"E  
2E 60W  
Fluted Opal Etched Glass

**I. 8-7710-4-SN**  
4-Light Bath Bar  
Satin Nickel Finish  
33"W x 8"H x 6-1/2"E  
4E 60W  
Fluted Opal Etched Glass

# COLTON



Fixtures may be mounted either uplight or downlight.



# COLTON

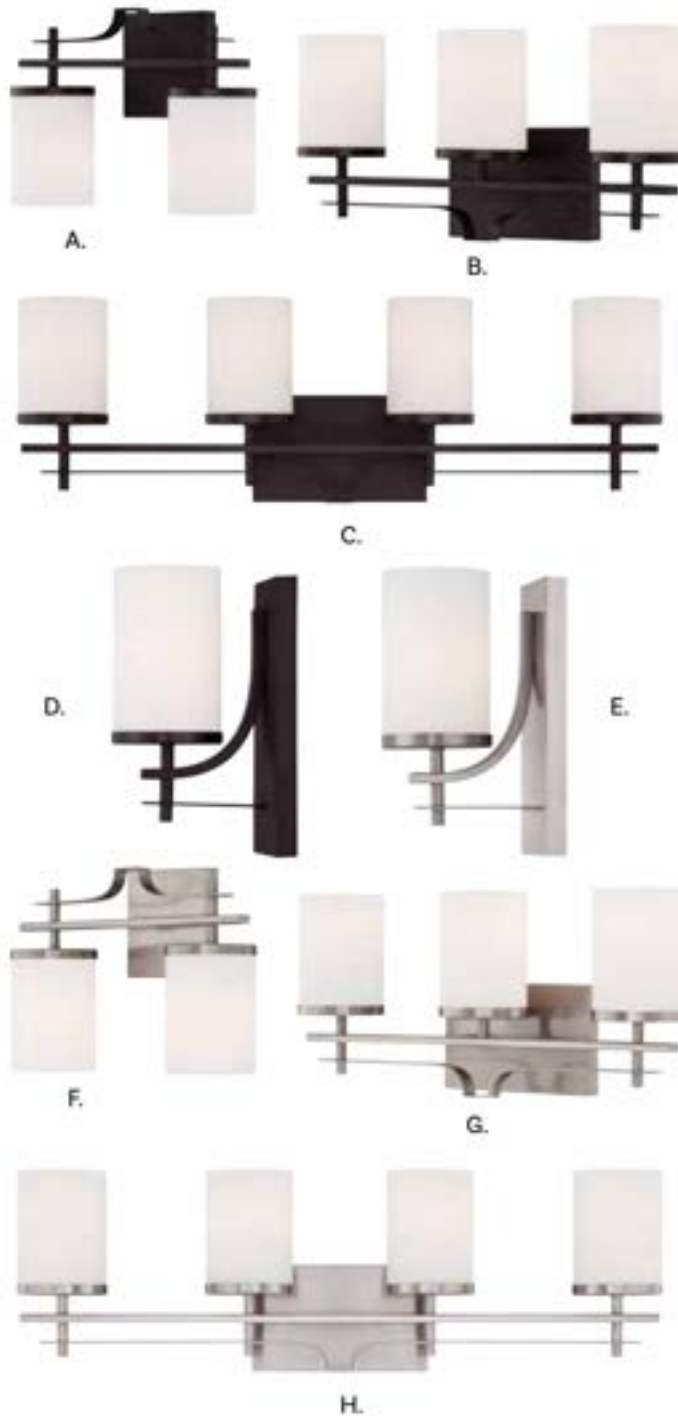

- A. 8-338-2-13**  
2-Light Bath Bar  
English Bronze Finish  
13-1/2"W x 9"H x 5"E  
2E 60W  
White Opal Glass
- B. 8-338-3-13**  
3-Light Bath Bar  
English Bronze Finish  
20-1/2"W x 9"H x 5"E  
3E 60W  
White Opal Glass
- C. 8-338-4-13**  
4-Light Bath Bar  
English Bronze Finish  
28-1/2"W x 9"H x 5"E  
4E 60W  
White Opal Glass
- D. 9-337-1-13**  
1-Light Sconce  
English Bronze Finish  
4-3/4"W x 10"H x 6"E  
1E 60W  
White Opal Glass
- E. 9-337-1-5N**  
1-Light Sconce  
Satin Nickel Finish  
4-3/4"W x 10"H x 6"E  
1E 60W  
White Opal Glass
- F. 8-338-2-5N**  
2-Light Bath Bar  
Satin Nickel Finish  
13-1/2"W x 9"H x 5"E  
2E 60W  
White Opal Glass
- G. 8-338-3-5N**  
3-Light Bath Bar  
Satin Nickel Finish  
20-1/2"W x 9"H x 5"E  
3E 60W  
White Opal Glass
- H. 8-338-4-5N**  
4-Light Bath Bar  
Satin Nickel Finish  
28-1/2"W x 9"H x 5"E  
4E 60W  
White Opal Glass

# HERNDON/YATES

## A. HERNDON

### 9-1007-1-SN

1-Light Sconce  
Satin Nickel Finish  
5-1/2"W x 10-3/4"H x 7-1/2"E  
1E 60W  
Frosted White Glass



A



B.

## B. HERNDON

### 8-1007-2-SN

2-Light Bath Bar  
Satin Nickel Finish  
18"W x 8"H x 7-1/2"E  
2E 60W  
Frosted White Glass



C.

## C. HERNDON

### 8-1007-3-SN

3-Light Bath Bar  
Satin Nickel Finish  
24"W x 8"H x 7-1/2"E  
3E 60W  
Frosted White Glass



D.

## D. HERNDON

### 8-1007-4-SN

4-Light Bath Bar  
Satin Nickel Finish  
30"W x 8"H x 7-1/2"E  
4E 60W  
Frosted White Glass



## E. YATES

### 8-6837-4-69

4-Light Bath Bar  
Pewter Finish  
31"W x 8-3/4"H x 7-1/2"E  
4E 60W  
White Glass

E.

## F. YATES

### 8-6837-2-69

2-Light Bath Bar  
Pewter Finish  
15"W x 8-3/4"H x 7-1/2"E  
2E 60W  
White Glass



F.



G.

## G. YATES

### 8-6837-3-69

3-Light Bath Bar  
Pewter Finish  
22-3/4"W x 8-3/4"H x 7-1/2"E  
3E 60W  
White Glass

# ELISE/KANE



## H. ELISE

### 8-9127-2-SN

2-Light Bath Bar  
Satin Nickel Finish  
12-1/4"W x 10-1/8"H x 6-1/2"E  
2E 60W  
Frosted Opal Glass

## I. ELISE

### 8-9127-1-SN

1-Light Sconce  
Satin Nickel Finish  
4-1/2"W x 10-1/2"H x 6-1/2"E  
1E 60W  
Frosted Opal Glass

## J. ELISE

### 8-9127-3-SN

3-Light Bath Bar  
Satin Nickel Finish  
20-1/2"W x 11"H x 6-1/2"E  
3E 60W  
Frosted Opal Glass

## K. KANE

### 8-890-4-SN

4-Light Bath Bar  
Satin Nickel Finish  
33"W x 8-1/2"H x 5-1/2"E  
4E 60W  
White Etched Glass

## L. KANE

### 8-890-3-SN

3-Light Bath Bar  
Satin Nickel Finish  
24"W x 8-1/2"H x 5-1/2"E  
3E 60W  
White Etched Glass

## M. KANE

















































### 8-890-2-SN

2-Light Bath Bar  
Satin Nickel Finish  
16"W x 8-1/2"H x 5-1/2"E  
2E 60W  
White Etched Glass

# FINISH GUIDE

	02 Oiled Bronze		62 Como Black w/ Gold		95 Warm Brass w/ Bronze Accents
	11 Polished Chrome		63 Warm Brass Lustre		96 Barrelwood w/ Brass Accents
	13 English Bronze		66 Matte Black w/ Satin Nickel		99 Provence
	21 Burnished Russet		67 Matte Black w/ Polished Chrome Accents		100 Aurora
	23 White Washed Driftwood		68 Whiskey Wood		101 Noblewood w/ Iron
	25 Slate		69 Pewter		109 Polished Nickel
	28 Oiled Burnished Bronze		70 Weathervane		110 Polished Chrome w/ Wooden Beads
	32 Artisan Rust		72 Rustic Bronze		111 Satin Nickel w/ Polished Nickel Accents
	36 Natural Walnut w/ Black Accents		76 Florentian Bronze		114 Britannia Gold
	38 Royal Gold		77 Bronze w/ Brass Accents		121 Mohican Bronze
	39 Fossil Stone		79 English Bronze & Warm Brass		124 Fiesta Bronze
	40 Walnut Patina		80 Matte White		127 Noble Brass
	41 Durango		81 Distressed White		128 Café
	44 Classic Bronze		82 Porcellana		129 Espresso
	45 Aged Wood		83 Bisque White		130 Aged Pewter
	46 Calypso		84 Rubbed Bronze W/ Gold Leaf		133 Sapele Finish
	47 White Cashmere		85 Rubbed Zinc w/ Silver Leaf		137 Textured Black w/ Warm Brass Accents
	50 Black Cashmere		88 Oxidized Black		139 Greywood w/ Pewter
	51 Vintage Black w/ Warm Brass Accents		89 Matte Black		142 White w/ Warm Brass Accents
	53 Silver Patina		90 Galvanized Metal		143 Black w/ Warm Brass Accents
	54 Gold Patina		92 Rumba		144 Matte Black w/ Burnished Brass Accents
	57 Polished Pewter		94 Avignon		
	60 Distressed Gold				

# FINISH GUIDE

	150 Kenyon Black & Chrome		180 Matte Black w/ Dark Rattan		320 Warm Brass & Rope
	153 Black w/ Gold Highlights		181 Gunsmoke w/ Gray Rattan		322 Warm Brass
	154 Antique Nickel		182 Chelsea Gold		323 Old Bronze
	155 Provence w/ Gold Accents		183 Chelsea Walnut		BK Black
	160 White w/ Brass Accents		184 Grapevine		BZ Bronze
	161 Navy Blue w/ Warm Brass Accents		185 Lodge Finish		CH Chrome
	162 Aged Driftwood		187 Brushed Pewter		SN Satin Nickel
	165 Satin Nickel w/ Gray Wood		190 Forged Iron		WH White
	166 Black w/ Greywood		191 Darkwood w/ Black Accents		
	168 Galvanized Aluminum		193 Sweetgum		
	170 Burnished Brass w/ Walnut		194 Mesquite		
	171 Burnished Brass		195 Warm Brass w/ Chrome Accents		
	172 White w/ Polished Nickel Accents		196 Reclaimed Wood		
	173 Black w/ Polished Nickel Accents		198 Natural Antler		
	174 Navy w/ Polished Nickel Accents		211 Argentum		
	175 Gray w/ Polished Nickel Accents		212 Argentum & Gold		
	177 Burnished Brass w/ Natural Rattan		213 English Bronze w/ Gold		
	178 Aspen		242 Aged Steel		
	179 Mottled Zinc w/ Natural Rattan		260 True Gold		
			261 Matte Black w/ True Gold		
			272 Silver Dust		
			307 Silver Sparkle		

Savoy House mini-pendants are supplied with three 9-1/2" extension rods.

# INDEX

1-1000-3-SN.....	111	1-190-5-109.....	125	1-326-3-322.....	126	1-7000-6-322.....	68
1-1001-5-SN.....	111	1-190-5-322.....	125	1-326-3-44.....	126	1-7000-6-77.....	69
1-1008-5-SN.....	111	1-190-5-89.....	125	1-327-5-322.....	126	1-7000-6-89.....	68
1-1021-5-322.....	103	1-190-5-SN.....	125	1-327-5-44.....	126	1-7001-12-109.....	71
1-1021-5-89.....	101	1-2450-6-322.....	78	1-330-5-SN.....	109	1-7001-12-322.....	70
1-1021-5-SN.....	102	1-2450-6-89.....	78	1-4032-5-11.....	107	1-7001-12-77.....	71
1-1023-5-322.....	103	1-2451-8-322.....	78	1-4032-5-13.....	107	1-7001-12-89.....	70
1-1023-5-89.....	101	1-2451-8-89.....	78	1-4032-5-322.....	105	1-8200-5-109.....	11
1-1023-5-SN.....	102	1-2520-6-322.....	80	1-4032-5-BK.....	105	1-8200-5-322.....	11
1-1613-4-322.....	31	1-2520-6-89.....	80	1-4032-5-SN.....	106	1-8200-5-89.....	11
1-1613-4-89.....	31	1-2540-5-109.....	91	1-4033-9-BK.....	105	1-8203-3-109.....	13
1-1614-3-322.....	33	1-2540-5-322.....	91	1-4033-9-SN.....	106	1-8203-3-322.....	13
1-1614-3-89.....	33	1-2540-5-89.....	91	1-423-3-322.....	121	1-8203-3-89.....	13
1-1623-6-322.....	41	1-2541-9-109.....	93	1-423-3-89.....	121	1-9772-10-322.....	24
1-1623-6-89.....	41	1-2541-9-322.....	93	1-424-5-109.....	123	1-9772-10-89.....	23
1-1624-8-322.....	39	1-2541-9-89.....	93	1-424-5-322.....	123	1-9773-12-322.....	24
1-1624-8-89.....	39	1-2802-6-322.....	36	1-424-5-44.....	123	1-9773-12-89.....	23
1-1630-5-143.....	83	1-2802-6-89.....	35	1-424-5-89.....	123	24-FD-8853-322.....	20
1-1630-5-173.....	83	1-2803-5-322.....	36	1-424-5-SN.....	123	24-FD-8853-89.....	20
1-1631-6-143.....	84	1-2803-5-89.....	35	1-4404-8-322.....	63	27-FD-8201-109.....	14
1-1631-6-173.....	84	1-307-6-322.....	55	1-4404-8-89.....	63	27-FD-8201-322.....	14
1-1756-6-109.....	89	1-307-6-89.....	55	1-4405-10-322.....	64	27-FD-8201-89.....	14
1-1756-6-322.....	89	1-3073-5-11.....	45	1-4405-10-89.....	64	3-1617-4-11.....	148
1-1756-6-89.....	89	1-3073-5-322.....	44	1-4406-15-322.....	67	3-1617-4-322.....	148
1-1785-6-322.....	87	1-3073-5-89.....	43	1-4406-15-89.....	66	3-1617-4-89.....	148
1-1785-6-89.....	87	1-3074-8-11.....	45	1-4410-5-109.....	75	3-2226-8-322.....	9
1-1786-5-322.....	87	1-3074-8-322.....	44	1-4410-5-322.....	75	3-2226-8-89.....	9
1-1786-5-89.....	87	1-3074-8-89.....	43	1-4410-5-89.....	75	3-420-3-109.....	112
1-1832-5-322.....	50	1-308-8-322.....	56	1-4412-8-109.....	77	3-420-3-322.....	112
1-1832-5-89.....	52	1-308-8-44.....	56	1-4412-8-322.....	77	3-420-3-44.....	112
1-1833-6-322.....	50	1-308-8-89.....	56	1-4412-8-89.....	77	3-420-3-89.....	112
1-1833-6-89.....	52	1-308-8-SN.....	56	1-5407-5-322.....	27	3-420-3-SN.....	112
1-1861-8-322.....	49	1-310-10-322.....	59	1-5407-5-89.....	28	3-421-4-109.....	115
1-1861-8-89.....	49	1-310-10-89.....	59	1-5409-5-322.....	27	3-421-4-322.....	115
1-1862-8-322.....	46	1-312-15-322.....	61	1-5409-5-89.....	28	3-421-4-44.....	115
1-1862-8-89.....	46	1-312-15-89.....	61	1-7000-6-109.....	69	3-421-4-89.....	115

# INDEX

3-421-4-SN.....115	6-1802-3-SN.....99	6-6835-2-SN.....208	7-1040-3-BK.....137
3-422-6-322.....117	6-1950-6-322.....191	6-7003-8-109.....194	7-1040-3-SN.....137
3-422-6-44.....117	6-1950-6-89.....191	6-7003-8-322.....194	7-1041-6-109.....135
3-422-6-89.....117	6-1951-6-322.....191	6-7003-8-77.....194	7-1041-6-13.....135
3-422-6-SN.....117	6-1953-4-109.....188	6-7003-8-89.....194	7-1041-6-BK.....135
3-4901-4-322.....132	6-1953-4-322.....188	6-7200-1-322.....178, 207	7-1041-6-SN.....135
3-4901-4-89.....132	6-1953-4-89.....188	6-7200-1-89.....178, 207	7-130-1-44.....184
3-4901-4-SN.....132	6-328-4-109.....119	6-7200-1-SN.....178, 207	7-130-1-63.....184
3-6612-4-322.....129	6-328-4-322.....119	6-7702-3-322.....130, 205	7-130-1-SN.....184
3-6612-4-89.....129	6-328-4-44.....119	6-7702-3-89.....130, 205	7-170-1-11.....157
3-6612-4-SN.....129	6-328-4-89.....119	6-7702-3-SN.....130, 205	7-170-1-322.....157
3-7700-3-322.....130	6-328-4-SN.....119	6-7790-3-322.....203	7-170-1-89.....157
3-7700-3-89.....130	6-3350-14-109.....198	6-7790-3-89.....203	7-1742-1-109.....176
3-7700-3-SN.....130	6-3350-14-13.....198	6-7790-3-SN.....203	7-1742-1-322.....176
3-7701-5-322.....130	6-3350-14-322.....199	6-780-11-13.....209	7-1742-1-89.....176
3-7701-5-89.....130	6-3350-14-SN.....199	6-780-11-322.....209	7-180-1-109.....167
3-7701-5-SN.....130	6-3350-16-109.....198	6-780-11-BK.....209	7-180-1-322.....167
6-1005-3-SN.....111	6-3350-16-13.....198	6-780-11-SN.....209	7-180-1-89.....167
6-1024-3-322.....206	6-3350-16-322.....199	6-780-13-13.....209	7-180-1-SN.....167
6-1024-3-89.....206	6-3350-16-SN.....199	6-780-13-322.....209	7-1803-3-322.....97
6-1024-3-SN.....206	6-3750-1-322.....144, 207	6-780-13-BK.....209	7-1803-3-89.....97
6-1043-3-109.....136, 206	6-3750-1-89.....144, 207	6-780-13-SN.....209	7-1803-3-SN.....97
6-1043-3-13.....136, 206	6-4035-3-11.....201	7-1003-3-SN.....111	7-1804-4-322.....97
6-1043-3-BK.....136	6-4035-3-13.....201	7-1004-3-SN.....111	7-1804-4-89.....97
6-1043-3-SN.....137, 206	6-4035-3-322.....201	7-1010-1-SN.....185	7-1804-4-SN.....97
6-133-16-109.....196	6-4035-3-8K.....201	7-1025-3-322.....103	7-1831-1-322.....50, 177
6-133-16-322.....196	6-4035-3-SN.....201	7-1025-3-89.....101	7-1831-1-89.....52, 177
6-133-16-44.....196	6-4037-1-11.....200	7-1025-3-SN.....102	7-1875-3-11.....165
6-134-3-109.....196	6-4037-1-13.....200	7-1026-1-322.....183	7-1875-3-13.....165
6-134-3-322.....196	6-4037-1-322.....200	7-1026-1-89.....183	7-1875-3-322.....165
6-134-3-44.....196	6-4037-1-BK.....200	7-1026-1-SN.....183	7-1875-3-89.....165
6-1679-5-322.....193	6-4037-1-SN.....200	7-1027-1-322.....183	7-200-3-322.....169
6-1679-5-89.....193	6-4900-4-322.....132, 204	7-1027-1-89.....183	7-200-3-57.....169
6-1679-5-SN.....193	6-4900-4-89.....132, 204	7-1027-1-SN.....183	7-2201-4-13.....163
6-1802-3-322.....99	6-4900-4-SN.....132, 204	7-1040-3-109.....136	7-2201-4-322.....163
6-1802-3-89.....99	6-6835-2-13.....208	7-1040-3-13.....136	7-2201-4-SN.....163

# INDEX

7-2224-5-322.....	9	7-4034-3-322.....	105	7-8840-1-SN.....	161	8-1020-3-SN.....	253
7-2224-5-89.....	9	7-4034-3-BK.....	105	7-8855-1-322.....	17	8-1020-4-322.....	253
7-2255-1-322.....	153	7-4034-3-SN.....	106	7-8855-1-89.....	17	8-1020-4-BK.....	253
7-2255-1-89.....	153	7-4036-1-11.....	187	7-8857-5-322.....	17	8-1020-4-SN.....	253
7-2255-1-SN.....	153	7-4036-1-13.....	187	7-8857-5-89.....	17	8-1627-2-11.....	285
7-2265-1-322.....	155	7-4036-1-322.....	187	7-8859-8-322.....	19	8-1627-2-322.....	285
7-2265-1-89.....	155	7-4036-1-BK.....	187	7-8859-8-89.....	19	8-1627-2-BK.....	285
7-2265-1-SN.....	155	7-4036-1-SN.....	187	7-9006-3-13.....	173	8-1627-3-11.....	285
7-231-1-109.....	142	7-4134-1-13.....	185	7-9006-3-322.....	173	8-1627-3-322.....	285
7-231-1-322.....	142	7-4134-1-SN.....	185	7-9006-3-89.....	173	8-1627-3-BK.....	285
7-231-1-323.....	142	7-4499-1-109.....	146	7-9006-3-SN.....	173	8-1627-4-11.....	285
7-231-1-89.....	142	7-4499-1-322.....	146	7-9044-3-322.....	5	8-1627-4-322.....	285
7-232-1-109.....	142	7-4499-1-89.....	146	7-9044-3-89.....	5	8-1627-4-BK.....	285
7-232-1-322.....	142	7-5012-1-109.....	168	7-9046-4-322.....	5	8-1745-2-109.....	251
7-232-1-323.....	142	7-5012-1-13.....	168	7-9046-4-89.....	5	8-1745-2-322.....	251
7-232-1-89.....	142	7-5012-1-322.....	168	7-9048-6-322.....	7	8-1745-2-BK.....	250
7-2521-4-322.....	80	7-6099-24-109.....	138	7-9048-6-89.....	7	8-1745-3-109.....	251
7-2521-4-89.....	80	7-6099-24-322.....	138	7-9063-1-67.....	170	8-1745-3-322.....	251
7-3075-1-11.....	181	7-6099-24-89.....	138	7-9063-1-95.....	170	8-1745-3-BK.....	251
7-3075-1-322.....	181	7-700-1-109.....	186	7-9064-1-67.....	170	8-1745-4-109.....	251
7-3075-1-89.....	181	7-7006-1-322.....	151	7-9064-1-95.....	170	8-1745-4-322.....	251
7-3100-1-322.....	169	7-7006-1-89.....	151	7-9132-1-109.....	174	8-1745-4-BK.....	251
7-3102-1-322.....	169	7-7006-1-SN.....	151	7-9132-1-13.....	174	8-1830-2-322.....	273
7-336-1-SN.....	109	7-701-1-SN.....	186	7-9132-1-322.....	174	8-1830-2-BK.....	273
7-3390-1-322.....	181	7-702-1-109.....	186	7-9132-1-89.....	174	8-1830-3-322.....	273
7-3390-1-89.....	181	7-702-1-13.....	186	7-9132-1-SN.....	174	8-1830-3-BK.....	273
7-3751-1-109.....	145	7-703-1-SN.....	186	7-9770-1-322.....	24	8-1830-4-322.....	273
7-3751-1-13.....	145	7-7201-1-322.....	178	7-9770-1-89.....	23	8-1830-4-BK.....	273
7-3751-1-322.....	145	7-7201-1-89.....	178	8-1007-2-SN.....	296	8-1860-2-322.....	266
7-3751-1-89.....	145	7-7201-1-SN.....	178	8-1007-3-SN.....	296	8-1860-2-BK.....	266
7-3751-1-SN.....	145	7-730-1-109.....	185	8-1007-4-SN.....	296	8-1860-3-322.....	266
7-3901-3-109.....	158	7-8801-3-109.....	140	8-1020-2-322.....	253	8-1860-3-BK.....	266
7-3901-3-322.....	158	7-8801-3-322.....	140	8-1020-2-BK.....	253	8-1860-4-322.....	266
7-3901-3-89.....	158	7-8801-3-89.....	140	8-1020-2-SN.....	253	8-1860-4-BK.....	266
7-4034-3-11.....	107	7-8840-1-322.....	161	8-1020-3-322.....	253	8-2542-2-109.....	287
7-4034-3-13.....	107	7-8840-1-89.....	161	8-1020-3-BK.....	253	8-2542-2-322.....	286



# INDEX

8-2542-2-89.....	287	8-4030-4-BK.....	269	8-6001-4-322.....	248	8-7710-3-BK.....	293
8-2542-3-109.....	287	8-4030-4-SN.....	271	8-6001-4-BK.....	249	8-7710-3-SN.....	293
8-2542-3-322.....	286	8-4050-2-322.....	263	8-6836-2-11.....	291	8-7710-4-322.....	293
8-2542-3-89.....	287	8-4050-2-BK.....	263	8-6836-2-13.....	290	8-7710-4-BK.....	293
8-2603-4-BK.....	259	8-4050-2-SN.....	262	8-6836-2-322.....	288	8-7710-4-SN.....	293
8-2603-4-CH.....	259	8-4050-3-322.....	263	8-6836-2-SN.....	289	8-8020-2-11.....	279
8-2603-6-BK.....	259	8-4050-3-BK.....	263	8-6836-3-11.....	291	8-8020-2-BK.....	279
8-2603-6-CH.....	259	8-4050-3-SN.....	262	8-6836-3-13.....	290	8-8020-3-11.....	279
8-3076-2-11.....	265	8-4050-4-322.....	263	8-6836-3-322.....	288	8-8020-3-BK.....	279
8-3076-2-322.....	265	8-4050-4-BK.....	263	8-6836-3-SN.....	289	8-8020-4-11.....	279
8-3076-2-BK.....	265	8-4050-4-SN.....	262	8-6836-4-11.....	291	8-8020-4-BK.....	279
8-3076-3-11.....	265	8-4090-2-109.....	282	8-6836-4-13.....	290	8-890-2-SN.....	297
8-3076-3-322.....	265	8-4090-2-322.....	282	8-6836-4-322.....	288	8-890-3-SN.....	297
8-3076-3-BK.....	265	8-4090-3-109.....	282	8-6836-4-SN.....	289	8-890-4-SN.....	297
8-3076-4-11.....	265	8-4090-3-322.....	282	8-6837-2-69.....	296	8-9127-1-SN.....	247, 297
8-3076-4-322.....	265	8-4090-4-109.....	282	8-6837-3-69.....	296	8-9127-2-SN.....	297
8-3076-4-BK.....	265	8-4090-4-322.....	282	8-6837-4-69.....	296	8-9127-3-SN.....	297
8-338-2-13.....	295	8-4300-2-BK.....	261	8-7045-2-322.....	257	8-9130-2-109.....	276
8-338-2-SN.....	295	8-4300-2-SN.....	261	8-7045-2-BK.....	257	8-9130-2-13.....	276
8-338-3-13.....	295	8-4300-3-BK.....	261	8-7045-2-SN.....	257	8-9130-2-322.....	275
8-338-3-SN.....	295	8-4300-3-SN.....	261	8-7045-3-322.....	257	8-9130-2-BK.....	275
8-338-4-13.....	295	8-4300-4-BK.....	261	8-7045-3-BK.....	257	8-9130-3-109.....	276
8-338-4-SN.....	295	8-4300-4-SN.....	261	8-7045-3-SN.....	257	8-9130-3-13.....	276
8-4030-2-11.....	269	8-5606-2-BK.....	255	8-7045-4-322.....	257	8-9130-3-322.....	275
8-4030-2-13.....	270	8-5606-2-SN.....	255	8-7045-4-BK.....	257	8-9130-3-BK.....	275
8-4030-2-322.....	270	8-5606-3-BK.....	255	8-7045-4-SN.....	257	8-9130-4-109.....	276
8-4030-2-BK.....	269	8-5606-3-SN.....	255	8-7205-2-BK.....	281	8-9130-4-13.....	276
8-4030-2-SN.....	271	8-5606-4-BK.....	255	8-7205-2-SN.....	281	8-9130-4-322.....	275
8-4030-3-11.....	269	8-5606-4-SN.....	255	8-7205-3-BK.....	281	8-9130-4-BK.....	275
8-4030-3-13.....	270	8-6001-2-109.....	249	8-7205-3-SN.....	281	9-0700-1-109.....	225
8-4030-3-322.....	270	8-6001-2-322.....	249	8-7205-4-BK.....	281	9-0700-1-322.....	225
8-4030-3-BK.....	269	8-6001-2-BK.....	249	8-7205-4-SN.....	281	9-0700-1-SN.....	225
8-4030-3-SN.....	271	8-6001-3-109.....	249	8-7710-2-322.....	293	9-0900CP-1-109.....	243
8-4030-4-11.....	269	8-6001-3-322.....	249	8-7710-2-BK.....	293	9-0900CP-1-13.....	243
8-4030-4-13.....	270	8-6001-3-BK.....	249	8-7710-2-SN.....	293	9-0900CP-1-322.....	243
8-4030-4-322.....	270	8-6001-4-109.....	249	8-7710-3-322.....	293	9-0900CP-1-89.....	243

# INDEX

9-0900CP-1-SN.....243	9-1801-1-89.....237	9-4030-1-13.....247, 270	9-900-1-322.....233
9-0901-1-109.....238	9-1801-1-SN.....237	9-4030-1-322.....247, 270	9-900-1-44.....233
9-0901-1-322.....238	9-1830-1-322.....273	9-4030-1-BK.....247, 269	9-9131CP-1-109.....245
9-0901-1-44.....238	9-1830-1-89.....273	9-4030-1-SN.....247, 271	9-9131CP-1-13.....245
9-0901-1-89.....238	9-1911-1-11.....213	9-4050-1-322.....247, 263	9-9131CP-1-322.....245
9-0901-1-SN.....238	9-1911-1-322.....213	9-4050-1-BK.....247, 263	9-9131CP-1-89.....245
9-0902-1-109.....226	9-1911-1-89.....213	9-4050-1-SN.....247, 262	9-9131CP-1-SN.....245
9-0902-1-322.....226	9-1914-1-322.....212	9-5201-1-322.....217	9-960-1-109.....244
9-0902-1-89.....226	9-1914-1-89.....212	9-5201-1-83.....217	9-960-1-13.....244
9-1007-1-SN.....111, 246, 296	9-1916-1-11.....235	9-5201-1-89.....217	9-960-1-322.....244
9-101-1-109.....219	9-1916-1-322.....235	9-5202-2-322.....217	9-960-1-89.....244
9-101-1-322.....219	9-1916-1-89.....235	9-5202-2-83.....217	9-960-1-SN.....244
9-101-1-89.....218	9-1918-1-150.....234	9-5202-2-89.....217	9-961CP-1-109.....242
9-101-1-SN.....218	9-1918-1-77.....234	9-5405-1-322.....27	9-961CP-1-13.....242
9-103-2-109.....219	9-1972-1-322.....246	9-5405-1-89.....28	9-961CP-1-322.....242
9-103-2-322.....218	9-2542-1-109.....224, 287	9-6001-1-109.....248	9-961CP-1-89.....242
9-103-2-89.....219	9-2542-1-322.....224, 286	9-6001-1-322.....248	9-961CP-1-SN.....242
9-103-2-SN.....218	9-2542-1-89.....224, 287	9-6001-1-89.....248	9-9771-2-322.....24
9-108-1-322.....240	9-2801-1-322.....36	9-6520-1-109.....211	9-9771-2-89.....23
9-108-1-89.....240	9-2801-1-89.....35	9-6520-1-322.....211	9-996-1-109.....230
9-108-1-SN.....240	9-302-1-109.....223	9-6520-1-89.....211	9-996-1-322.....230
9-1200-1-109.....239	9-302-1-322.....222	9-6836-1-11.....246, 291	9-996-1-89.....230
9-1200-1-322.....239	9-302-1-44.....222	9-6836-1-13.....246, 290	9-996-1-SN.....230
9-1200-1-89.....239	9-302-1-89.....221	9-6836-1-322.....246, 288	9-998-2-109.....214
9-1200-1-SN.....239	9-302-1-SN.....221	9-6836-1-SN.....246, 289	9-998-2-322.....214
9-16000-1-109.....232	9-303-1-109.....223	9-7005-1-322.....236	9-998-2-44.....214
9-16000-1-322.....232	9-303-1-322.....222	9-7005-1-89.....236	9-998-2-89.....214
9-16000-1-44.....232	9-303-1-44.....222	9-7005-1-SN.....236	9-998-2-SN.....214
9-1615-1-322.....31	9-303-1-89.....221	9-7140-1-322.....227	
9-1615-1-89.....31	9-303-1-SN.....221	9-7140-1-SN.....227	
9-1632-1-143.....83	9-3076-1-11.....264	9-7144-1-109.....223	
9-1632-1-173.....83	9-3076-1-322.....264	9-7144-1-322.....222	
9-1755-1-109.....229	9-3076-1-89.....264	9-7144-1-44.....222	
9-1755-1-322.....229	9-337-1-13.....246, 295	9-7144-1-89.....221	
9-1755-1-89.....229	9-337-1-SN.....246, 295	9-7144-1-SN.....221	
9-1801-1-322.....237	9-4030-1-11.....247, 269	9-900-1-109.....233	





3130 North Berkeley Lake Road NW | Duluth, GA 30096  
TEL 800 801 1621 TEL 404 890 7540 FAX 877 547 2869  
SAVOYHOUSE.COM

E08

